

Experimental Validation of the Characterisation of Highly Flexible Adhesives Using Multiple Specimen Configurations

**F. J. Simón-Portillo, O. Cuadrado, E. A. S. Marques, M. Sánchez-Lozano,
and Lucas F. M. da Silva**

Abstract The mechanical characterisation of adhesives with hyperelastic behaviour is complex task and the accuracy of these material modes should be validated in joints subjected to different types of stress. In a previous work by the authors, the hyperelastic behaviour laws of the adhesive were determined and validated by means of the Single Lap Joint (SLJ) test. As a result, it was determined that the Mooney Rivlin model provides the best fit for the adhesive behaviour. The current work expands upon this by first carrying out an experimental analysis of the behaviour of the adhesive under cleavage loads, using the Double Cantilever Beam (DCB) specimen configuration and then assessing the behaviour of the adhesive under tension using a T specimen configuration. In both cases, the response of the adhesive two different adhesive thickness values are analysed. The second part focuses on the validation of the Mooney Rivling behavioural law that has been previously proposed, assessing its effectiveness under tensile and tearing stresses. Finite element models are then developed and compared with the experimental results obtained in the first part.

F. J. Simón-Portillo (✉) · O. Cuadrado · M. Sánchez-Lozano
Department of Mechanical and Energy Engineering, Miguel Hernandez University, 03202 Elche,
Spain
e-mail: f.simon@umh.es

O. Cuadrado
e-mail: o.cuadrado@umh.es

M. Sánchez-Lozano
e-mail: msanchez@umh.es

E. A. S. Marques
Institute of Science and Innovation in Mechanical and Industrial Engineering (INEGI), Rua Dr.
Roberto Frias, 4200-465 Porto, Portugal
e-mail: emarques@inegi.up.pt

L. F. M. da Silva
Department of Mechanical Engineering, Faculty of Engineering, University of Porto, 4200-465
Porto, Portugal
e-mail: lucas@fe.up.pt

Keywords Finite Element · Hyperelastic Models · Traction · Peel · Polyurethane

1 Introduction

The use of adhesives has grown substantially in various industrial fields, especially in the marine, aerospace and automotive sectors (Cavezza et al. 2020; Amstutz et al. 2018; Lu et al. 2014). The increasing need for lightweight structures has led industries to adopt larger amounts of composite materials, seeking to develop more efficient products through the exploitation of their optimal specific mechanical properties of composites (Mazlan et al. 2022; Pathak and Dhakate 2022). Although composites have many important advantages, traditional joining techniques, such as bolted joints, often involve operations such as drilling that may cause damage to these materials. Thus, the use of adhesives is preferred for composite structures (da Silva and Campilho 2015). Adhesive bonding also allows for a more uniform stress distribution in the bondline and, may also prevent corrosion of substrates due to its inherent sealing properties. In recent years, highly flexible structural adhesives have reached the market and have also gained importance. These adhesives behave similarly to rubber and other elastomers and are able to undergo large changes in shape without any permanent deformation or damage, making them ideal for applications requiring flexibility and strength (Loureiro et al. 2010; Banea and Da Silva 2009; Lubowiecka et al. 2012). The characterization of the mechanical properties of highly flexible adhesives is still relatively unexplored, especially under different types of stresses (Domingues et al. 2015; Galvez et al. 2017).

Although adhesives are primarily designed to resist shear forces, mechanical components often face different conditions and loading modes during their lifetime. Therefore, it is essential to carry out studies of the performance of adhesive bonds under different conditions (Da Silva et al. 2012; Banea and Da Silva 2009). In this work, joints subjected to tearing and tensile stresses are analysed in order to understand their behaviour under these stresses.

In order to ensure that adhesive joints can perform satisfactorily in structural applications, it is essential to model and optimise the joint performance. The use of finite element modelling (FEM) is a powerful tool at the disposal of the bonded joint designer. However, even highly advanced models are unable to accurate and reliable results without precise material characterisation data (Narayana Naik 2019; Campilho 2013). This is especially true for highly flexible adhesives, with non-linear elastic behaviour in the large strain range that can only be successfully described through hyperelastic material constitutive models (Hesebeck and Wulf 2018; Holzapfel 2000; Kim et al. 2012; Chiminelli et al. 2019). Such models account for the large deformation levels reached by these adhesives before failure. The fitting of the hyperelastic model and the validation of the model using SLJ specimens of different adhesive thicknesses was carried out by the authors in a previous work, pending publication. In this work, the Mooney Rivlin model was found to be the best fit for determining the behavioural law of this type of adhesive, fitted only using

the results of two simple mechanical characterisation tests of the adhesive. With the adjusted constants, the simulation of the behaviour of the adhesive under different loading conditions should also be achieved, being this the main objective that drives this work.

The first part of this research consists of an experimental study on the mechanical behaviour of the adhesive, with an analysis of how the adhesive thickness influences the cleavage and tensile behaviour (Banea et al. 2014). Firstly, specimens with adhesive thicknesses of 2, 3, 4 and 6 mm were tested using the double cantilever beam (DCB) configuration, providing a cleavage type of loading. Subsequently, tensile tests were carried out using T-shaped specimens with 4 and 6 mm thick adhesive layers.

Finally, in order to validate the material model under generic tensile and cleavage loads, finite element models of the joints were developed, using the behavioural law fitted in the aforementioned previous investigations and then validated against experimental data.

2 Materials and Methods

The adhesive considered for this research is a single-component polyurethane (PUR) adhesive, Sikaflex 252, designed for use in highly flexible joints. This type of adhesive cures by reacting with moisture, forming a high performance elastomer (Kordová et al. 2022).

As mentioned in the previous section, two types of specimens are used in this research. These are described in the following paragraphs.

- Traction

The joints were manufactured with an adhesive surface measuring 50×50 mm. To ensure a precise alignment between the two adhesives and to be able to properly control the thickness of the adhesive, a special 3D printed tooling has been designed, as shown in Fig. 1. Aluminium is used as an adherend, with a modulus of elasticity of 70 GPa.

- Cleavage

The specimen used for the cleavage test was manufactured using the DCB configuration, with a width of 25 mm and a length of 100 mm. The details of this configuration are shown in Fig. 2. These joints were manufactured following some of the guidelines set out in ASTM D3433. The adherends were made of steel, with a Young's modulus of 200 GPa.

In this study, the aim is to ensure that almost all of the deformation takes place within the adhesive layer. Therefore, adhesives that are sufficiently rigid to avoid their deformation have been designed in both configurations.

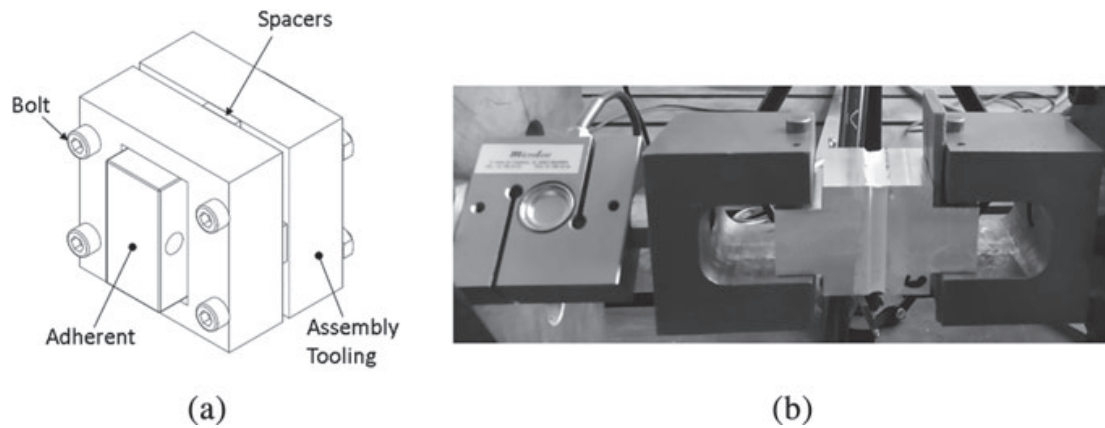

Fig. 1 Tensile joint fabrication tooling (a), test equipment (b)

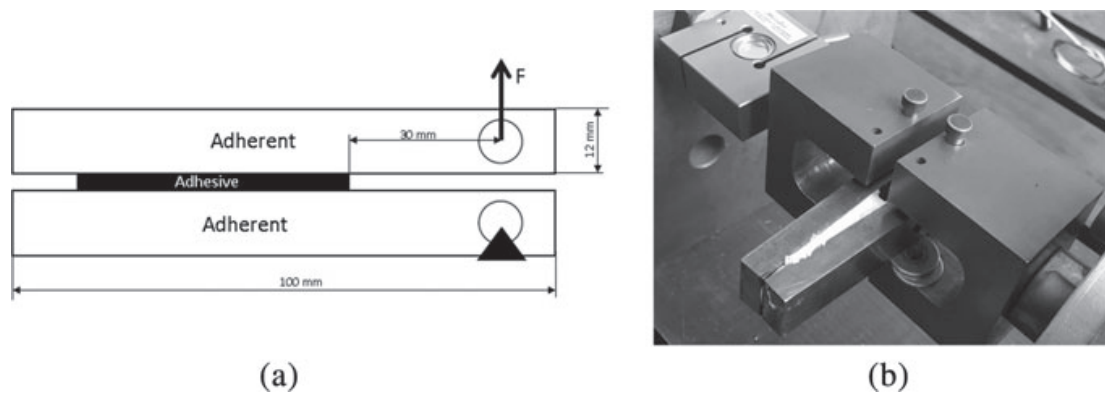

Fig. 2 Tear test tube (DCB) (a), test equipment (b)

To control the thickness of the adhesive, calibrated spacers coated with a release agent were used. To ensure a good level of adhesion and following the adhesive manufacturer's specifications, an adhesion promoter, in this case Sika Primer 206, was applied to both the steel and aluminium specimens. All tests were carried out under laboratory conditions (temperature of 23 °C and relative humidity 70%) using a testing machine equipped with a 20 kN load cell, with a controlled displacement rate of 10 mm/min.

3 Results and Experimental Discussion

In this section, the results of the quasi-static tests carried out are presented and analysed. Cleavage tests were carried out using double cantilever beam (DCB) specimens with adhesive layer thicknesses of 2, 3, 4 and 6 mm. Tensile tests were also carried out using the T-probe configuration, with adhesive thicknesses of 4 and 6 mm. Following the conclusion of the tests, cohesive failure was observed in all cases, indicating the successful selection of the surface treatment.

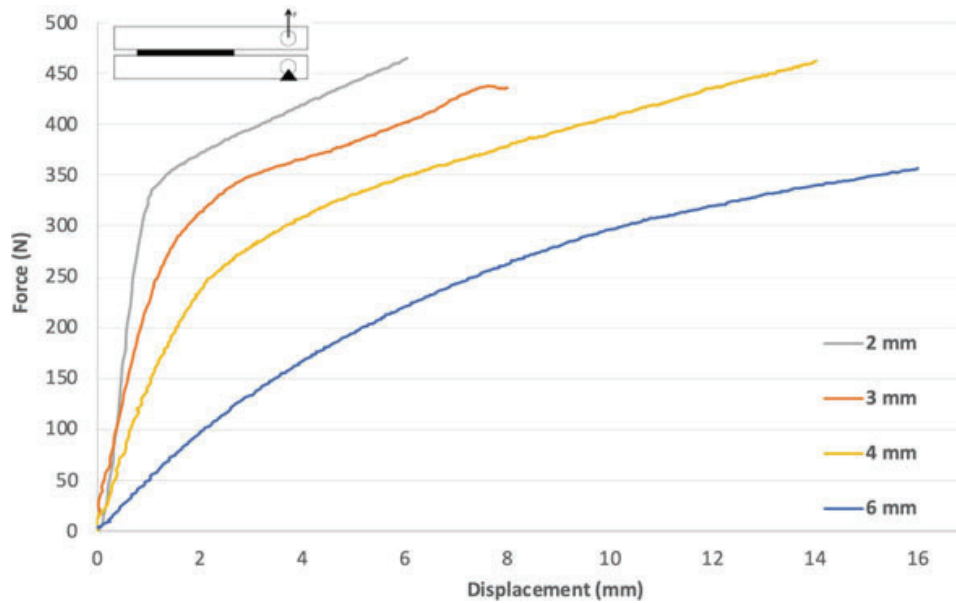

Fig. 3 Experimental results for DCB specimens with bondline thicknesses of 2, 3, 4 and 6 mm of SikaFlex 252

Figure 3 shows the force–displacement curves for the DCB tests, as function of the adhesive thickness. It can be seen that as the adhesive thickness decreases, the slope of the curves increases, indicating that the bond stiffness increases progressively. For the DCB specimen configuration and adhesive thicknesses of 2.3 and 4 mm, it can be seen that the load increased almost linearly with displacement in the initial phase, before reaching its strength limit and leading to failure of the adhesive layer.

Figure 4 shows the force–displacement curves corresponding to the tensile tests conducted with 4 and 6 mm adhesive thicknesses. In this case, it is also observed that as the adhesive thickness decreases, the slope of the curves slightly increases. In this type of joint, the level of stress required to initiate adhesive fracture is similar for both thicknesses. However, there is a difference since, for the 6 mm thick adhesive layer, fracture occurs with at a larger displacement, compared to the thinner adhesive.

In summary, the results obtained from the tear tests are shown in Table 1, and the results from the tensile tests in Table 2. This table gives the values of the maximum loads and displacements at the instants before fracture occurred in the adhesive, thus providing an overview of the experimental results obtained in the tests.

4 Comparison Between Experimental and Numerical Results

To obtain the constants of the hyperelastic models of order 1 and 2, stress–strain curves in two different loading configurations are first required (Crocker et al. 1999; Moreira and Nunes 2013). A uniaxial tensile test with halter specimens and a planar test, also known as “pure shear”, have been chosen. It is highly recommended to

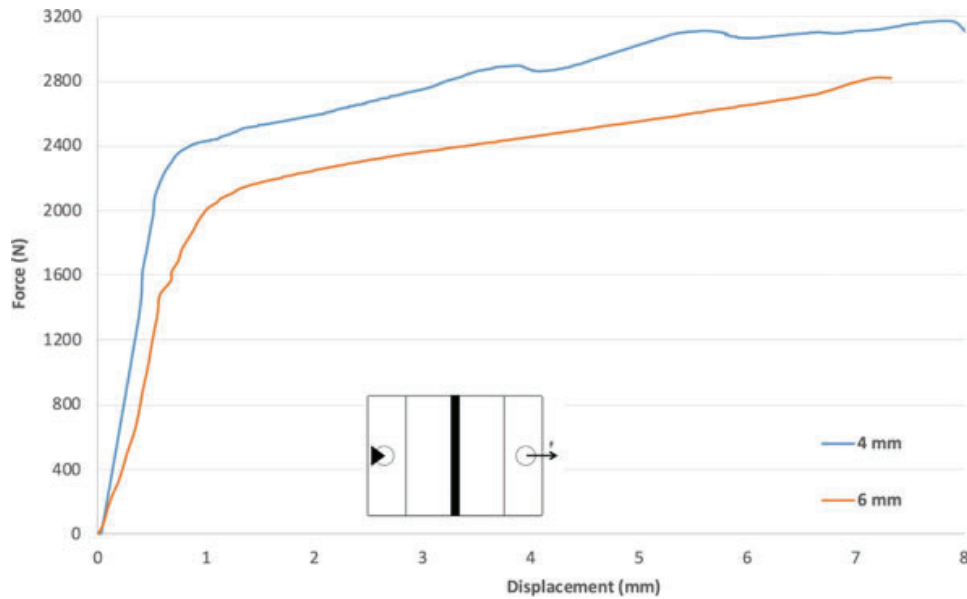

Fig. 4 Experimental results for tensile joints with thicknesses of 4 and 6 mm of SikaFlex 252

Table 1 Results for experimental DCB tests

DCB	Force max (N)	Displacement (mm)
2 mm	330	0.46
3 mm	275	1.8
4 mm	250	2.1
6 mm	150	3.5

Table 2 Results for experimental T-tensile tests

T	Force max (N)	Displacement (mm)
4 mm	2380	0.8
6 mm	2015	1

include the latter test in the characterisation of hyperelastic materials so that the shear behaviour of the material can be taken into account. The material models considered were: Neo-Hookean, Mooney-Rivlin (polynomial $N = 1$) and Ogden ($N = 1$ and $N = 2$) (Crocker et al. 1999; Duncan and Crocker 2001). It should be noted that, in this case, the compressibility constants are zero for any of the models, since it is assumed that this is an incompressible material. As mentioned above, the hyperelastic model has been adjusted and validated in previous investigations, pending publication.

As an example, Fig. 5 shows the validation results using the SLJ specimen with an adhesive thickness of 3 mm. This initial validation provides evidence of the model's ability to accurately represent adhesive behaviour in this bond configuration.

As part of the validation of the adhesive characterisation, modelling of DCB specimens with the geometries described in point 2 was carried out, using adhesive thicknesses of 4 and 6 mm. This modelling process aims to evaluate the accuracy

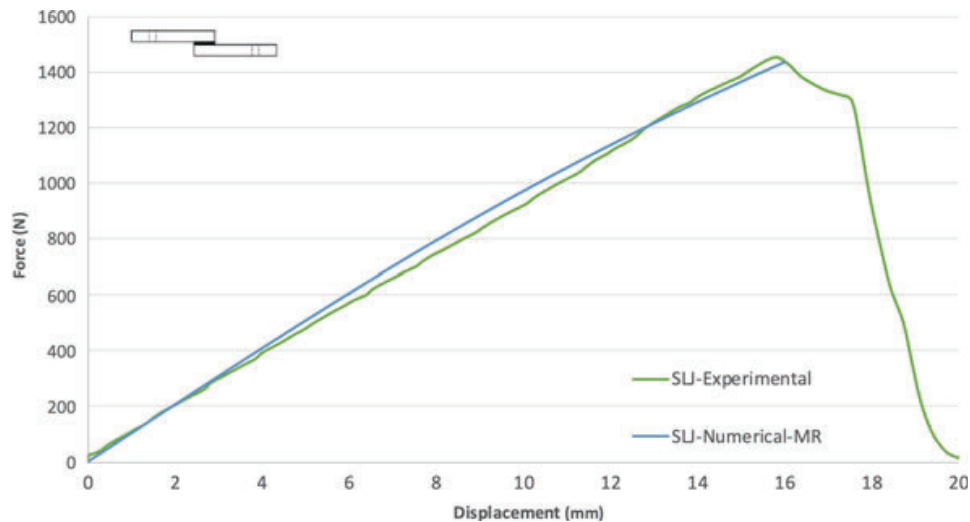

Fig. 5 Experimental results for SLJ-3 mm SikaFlex 252

and validity of the adhesive characterisation process, verifying whether the model is able to accurately predict the behaviour of the adhesive in the joints under different loads.

Following a similar methodology as that used to create a model of the SLJ specimen, a 3D finite element model was developed to validate both specimen configurations. Quasi-static analysis was carried out using Abaqus software. The steel for the DCB specimen is considered as a linear material. The mechanical properties of the adhesive are assumed according to the previously fitted hyperelastic model; using the Mooney-Rivlin model to define the constitutive law. Quadratic hexahedral elements with reduced integration were used in order to reduce the mesh density without affecting the accuracy of the solution. Additionally, a mesh convergence study was performed to determine the optimal element size in each case.

The boundary conditions were defined as shown in Fig. 6. One end is embedded, allowing rotation, while a displacement is applied at the other end, also allowing rotation. The force-displacement response was analysed up to a displacement range of 2 mm for the specimen with an adhesive thickness of 4 mm and 3 mm for the specimen with an adhesive thickness of 6 mm.

The results obtained from the simulation show an acceptable correlation with the experimental results for both specimen configurations, up to moments prior to adhesive failure. This indicates that the Mooney-Rivlin model used is adequate for defining the behaviour of the adhesive under tearing loads. Going into more detail in each of the configurations, as can be seen in Fig. 7, the slopes of the experimental and numerical curves are very similar in each of them.

In the simulations, the adhesive deformation (δ) in the direction of adhesive thickness was assessed (Fig. 6). In the case of the specimen with an adhesive thickness of 4 mm, an adhesive deformation of 1.2 mm was observed with no evidence of damage. For the 6 mm specimen, a deformation of 3 mm was achieved. These results indicate the ability of the adhesive to deform and absorb loads before reaching a critical point of damage.

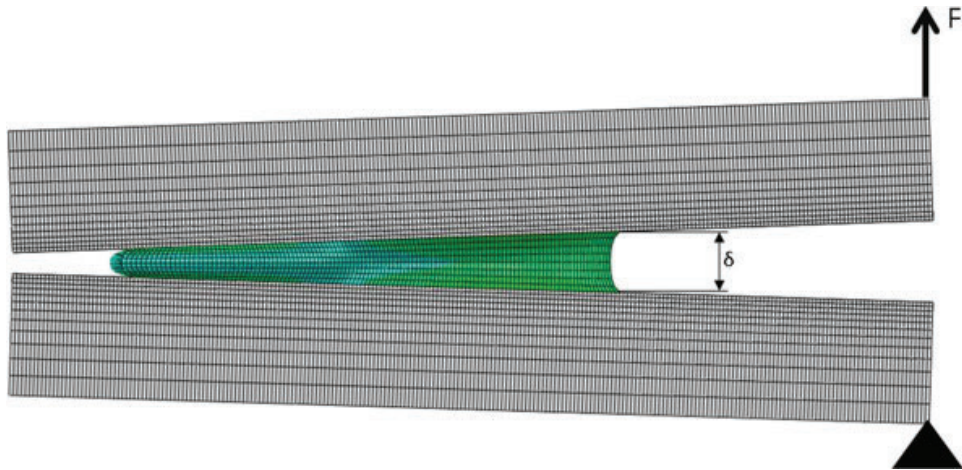

Fig. 6 FE simulation DCB

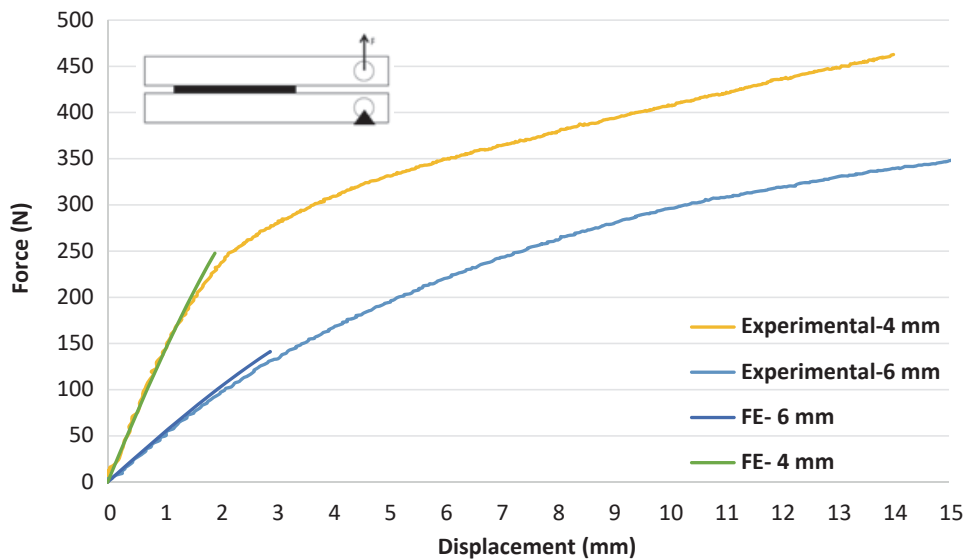

Fig. 7 Experimental results for DCB 4–6 mm bonding of SikaFlex 252

5 Conclusions

In view of the results obtained, the Mooney Rivlin hyperelastic model has been found to be able to reproduce the behaviour of joints subjected to tearing load with a fair degree of accuracy. These results support the validity of the model and demonstrate its ability to predict adhesive performance in similar situations.

In light of these results, the mechanical characterisation process of the flexible adhesive has been satisfactorily completed. The results obtained provide a solid

understanding of the behaviour of the adhesive under different loading conditions and adhesive thicknesses.

The mechanical characterisation of the adhesive at high temperatures and the fracture characterisation of the highly flexible adhesive are proposed as future lines of work. These lines of work will contribute to improve the understanding of adhesives in different scenarios and to develop more efficient solutions adapted to different conditions of use.

References

- Amstutz, C., Bürgi, M., Jousset, P.: Characterisation and FE simulation of polyurethane elastic bonded joints under multiaxial loading conditions. *Int. J. Adhes. Adhes.* **83**, 103–115 (2018). <https://doi.org/10.1016/J.IJADHADH.2018.02.029>
- Banea, M.D., Da Silva, L.F.M.: Adhesively bonded joints in composite materials: an overview. *Proc. Inst. Mech. Eng. Part L: J. Mater. Des. Appl.* **223**(1), 1–18 (2009). <https://doi.org/10.1243/14644207JMDA219>
- Banea, M.D., Da Silva, L.F.M., Campilho, R. D.S.G.: The effect of adhesive thickness on the mechanical behavior of a structural polyurethane adhesive. *J. Adhes.* **91**(5), 331–346 (2014). <https://doi.org/10.1080/00218464.2014.903802>
- Campilho, R.D.S.G., Banea, M.D., Neto, J.A.B.P., Da Silva, L.F.M.: Modelling adhesive joints with cohesive zone models: effect of the cohesive law shape of the adhesive layer. *Int. J. Adhes. Adhes.* **44**, 48–56 (2013). <https://doi.org/10.1016/j.ijadhadh.2013.02.006>
- Cavezza, F., Boehm, M., Terry, H., Hauffman, T.: A review on adhesively bonded aluminium joints in the automotive industry. *Metals* (2020). <https://doi.org/10.3390/met10060730>
- Chiminelli, A., Valero, C., Lizaranzu, M., López, C.I., Canales, M.: Modelling of bonded joints with flexible adhesives. *J. Adhes.* **95**(5–7), 369–384 (2019). <https://doi.org/10.1080/00218464.2018.1562347>
- Crocker, L.E., Duncan, B.C., Hughes, R.G., Urquhart, J.M.: Hyperelastic modelling of flexible adhesives (1999). https://www.researchgate.net/publication/281283309_HYPERELASTIC_MODELING_OF_FLEXIBLE_ADHESIVES
- Domingues, N.R.E., Campilho, R.D.S.G., Carbas, R.J.C., Da Silva, L.F.M.: Experimental and numerical failure analysis of aluminium/composite single-L joints (2015). <https://doi.org/10.1016/j.ijadhadh.2015.10.011>
- Duncan, B., Crocker, L.: Characterisation of Flexible Adhesives for Design. The National Physical Laboratory (NPL) (2001). <https://doi.org/10.47120/npl.mgpg45>
- Galvez, P., Quesada, A., Martinez, M.A., Abenojar, J., Jesus, M., Boada, L., Diaz, V.: Study of the behaviour of adhesive joints of steel with CFRP for its application in bus structures (2017). <https://doi.org/10.1016/j.compositesb.2017.07.018>
- Hesebeck, O., Wulf, A.: Hyperelastic constitutive modeling with exponential decay and application to a viscoelastic adhesive. *Int. J. Solids Struct.* **141–142**, 60–72 (2018). <https://doi.org/10.1016/J.IJSOLSTR.2018.02.011>
- Holzappel, G.A.: *Nonlinear Solid Mechanics : A Continuum Approach for Engineering*, p. 455. Wiley (2000)
- Kim, B., Lee, S.B., Lee, J., Cho, S., Park, H., Yeom, S., Park, S.H.: A comparison among Neo-Hookean model, Mooney-Rivlin model, and Ogden model for chloroprene rubber. *Int. J. Precis. Eng. Manuf.* **13**(5), 759–764 (2012). <https://doi.org/10.1007/s12541-012-0099-y>
- Kordová, T., Mareška, A., Míka, M.H.: Experimental analysis on the curing and adhesive behaviour of standard moisture-cured and fast-cured polyurethanes used in automotive industry. *Manuf. Technol.* **22**(2), 168–179 (2022). <https://doi.org/10.21062/MFT.2022.029>

- Loureiro, A.L., Da Silva, L.F.M., Sato, C., Figueiredo, M.A.V.: Comparison of the mechanical behaviour between stiff and flexible adhesive joints for the automotive industry. *J. Adhes.* **86**(7), 765–787 (2010). <https://doi.org/10.1080/00218464.2010.482440>
- Lu, Y., Broughton, J., Winfield, P.: A review of innovations in disbonding techniques for repair and recycling of automotive vehicles. *Int. J. Adhes. Adhes.* (2014). <https://doi.org/10.1016/j.ijadh.2014.01.021>
- Lubowiecka, I., Rodríguez, M., Rodríguez, E., Martínez, D.: Experimentation, material modelling and simulation of bonded joints with a flexible adhesive. *Int. J. Adhes. Adhes.* **37**, 56–64 (2012). <https://doi.org/10.1016/j.ijadh.2012.01.010>
- Mazlan, N., Chai Hua, T., Sapuan, S.M., Ilyas, R.A.: Evolution of aerospace composite materials. *Adv. Compos. Aeros. Eng. Appl.* 367–385 (2022). https://doi.org/10.1007/978-3-030-88192-4_18/FIGURES/4
- Moreira, D.C., Nunes, L.C.S.: Comparison of simple and pure shear for an incompressible isotropic hyperelastic material under large deformation. *Polymer Testing*. Accessed July 3, 2021. <https://www.sciencedirect.com/science/article/pii/S0142941812002218>
- Narayana Naik, G.: Single and dual adhesive bond strength analysis of single lap joint between dissimilar adherends (2019). <https://doi.org/10.1016/j.ijadh.2019.04.016>
- Pathak, A.K., Dhakate, S.R.: Carbon nanomaterial-carbon fiber hybrid composite for lightweight structural composites in the aerospace industry: synthesis, processing, and properties. *Adv. Compos. Aeros. Eng. Appl.* 445–470 (2022). https://doi.org/10.1007/978-3-030-88192-4_23/TABLES/3
- da Silva, L.F.M., Campilho, R.D.S.G.: Design of adhesively-bonded composite joints. *Fatigue Fract. Adhes.-Bonded Compos. Joints* 43–71 (2015). <https://doi.org/10.1016/B978-0-85709-806-1.00002-1>
- da Silva, L.F.M., Dillard, D.A., Blackman, B., Adams, R.D.: Testing adhesive joints: best practices (2012)