



**INVOLVEMENT OF TRANSIENT RECEPTOR POTENTIAL
CHANNELS IN THE SEXUAL DIMORPHISM OF A MOUSE
MODEL OF CHRONIC MIGRAINE**

David Alarcón Alarcón

Tesis Doctoral

Director: Antonio Ferrer Montiel

Codirector: David Cabañero Ferri

Programa de Doctorado en Biología Molecular y Celular

Instituto de Investigación, Desarrollo e Innovación en Biotecnología Sanitaria de
Elche (IDiBE)

Universidad Miguel Hernández de Elche

-2022-





La presente Tesis Doctoral, titulada "INVOLVEMENT OF TRANSIENT RECEPTOR POTENTIAL CHANNELS IN THE SEXUAL DIMORPHISM OF A MOUSE MODEL OF CHRONIC MIGRAINE", se presenta bajo la modalidad de **compendio de publicaciones, recogidas en ANEXOS:**

Alarcón-Alarcón, D., Cabañero, D., de Andrés-López, J. *et al.* TRPM8 contributes to sex dimorphism by promoting recovery of normal sensitivity in a mouse model of chronic migraine. *Nat Commun* **13**, 6304 (2022). doi.org/10.1038/s41467-022-33835-3

(Q1; Factor de Impacto 2022: 17.694).

†Contribución como primer autor.



Otros trabajos publicados estrechamente relacionados con el objeto de interés de esta tesis no incluidos en este compendio se citan a continuación:

Journigan VB, Alarcón-Alarcón D[†], Feng Z, Wang Y, Liang T, Dawley DC, Amin ARM, Montano C, Van Horn WD, Xie XQ, Ferrer-Montiel A, Fernández-Carvajal A. Structural and in Vitro Functional Characterization of a Menthyl TRPM8 Antagonist Indicates Species-Dependent Regulation. ACS Med Chem Lett. 2021 Mar 31;12(5):758-767. [doi: 10.1021/acsmchemlett.1c00001](https://doi.org/10.1021/acsmchemlett.1c00001). PMID: 34055223; PMCID: PMC8155240.

Mira A, Rubio-Camacho M, Alarcón-Alarcón D, Rodríguez-Cañas E, Fernández-Carvajal A, Falco A, Mallavia R. L-Menthol-Loadable Electrospun Fibers of PMVEMA Anhydride for Topical Administration. Pharmaceutics. 2021 Nov 3;13(11):1845. [doi: 10.3390/pharmaceutics13111845](https://doi.org/10.3390/pharmaceutics13111845). PMID: 34834260; PMCID: PMC8618103.

Giorgi S, Nikolaeva-Koleva M, Alarcón-Alarcón D, Butrón L, González-Rodríguez S. Is TRPA1 *Burning Down* TRPV1 as Druggable Target for the Treatment of Chronic Pain? Int J Mol Sci. 2019 Jun 14;20(12):2906. [doi: 10.3390/ijms20122906](https://doi.org/10.3390/ijms20122906). PMID: 31197115; PMCID: PMC6627658.

[†]Contribución como primer autor.



El **Dr. Antonio Ferrer Montiel**, director, y el **Dr. David Cabañero Ferri**, codirector de la tesis doctoral titulada "INVOLVEMENT OF TRANSIENT RECEPTOR POTENTIAL CHANNELS IN THE SEXUAL DIMORPHISM OF A MOUSE MODEL OF CHRONIC MIGRAINE"

INFORMAN:

Que David Alarcón Alarcón Alarcón ha realizado bajo nuestra supervisión el trabajo titulado "INVOLVEMENT OF TRANSIENT RECEPTOR POTENTIAL CHANNELS IN THE SEXUAL DIMORPHISM OF A MOUSE MODEL OF CHRONIC MIGRAINE" conforme a los términos y condiciones definidos en su Plan de Investigación y de acuerdo al Código de Buenas Prácticas de la Universidad Miguel Hernández de Elche, cumpliendo los objetivos previstos de forma satisfactoria para su defensa pública como tesis doctoral.

Y para que así conste a efectos oportunos, se expide por escrito.

Director de la tesis

Codirector de la tesis

Dr. Antonio Ferrer Montiel

Dr. David Cabañero Ferri



Dra. Asia Fernández Carvajal, Catedrática y Coordinadora del Programa de Doctorado en Biología Molecular y Celular del Instituto de Investigación, Desarrollo e Innovación en Biotecnología Sanitaria de Elche (IDiBE) de la Universidad Miguel Hernández de Elche.

DA SU CONFORMIDAD para el depósito y la defensa de la tesis doctoral titulada: “INVOLVEMENT OF TRANSIENT RECEPTOR POTENTIAL CHANNELS IN THE SEXUAL DIMORPHISM OF A MOUSE MODEL OF CHRONIC MIGRAINE”, presentada por D. David Alarcón Alarcón, mediante el procedimiento presencial.

Y para que así conste a los efectos oportunos, se expide el presente documento

Fdo: Dra. Asia Fernández Carvajal
Coordinadora de la CAPD de Biología Molecular y Celular
Universidad Miguel Hernández

La presente tesis doctoral, realizada en el instituto de Investigación Desarrollo e innovación en Biotecnología Sanitaria de Elche (IDiBE), ha sido financiada por el MINECO, por medio una beca FPI (BES-2016-077985) asociada a un proyecto de investigación nacional (SAF2015-66275-C2-1-R).



MINISTERIO
DE ECONOMÍA, INDUSTRIA
Y COMPETITIVIDAD



***"You step onto the road, and if you don't keep your feet,
there's no knowing where you might be swept off to."***

J.R.R. Tolkien, The Lord of the Rings

CONTENT

ABBREVIATIONS	13
ABSTRACT	18
INTRODUCTION	21
1. Pain.....	21
1. Pain concept and classification.....	21
2. The somatosensory system.....	22
3. Nociceptor classification.....	27
4. the nociceptor function.....	30
5. Nociceptor sensitisation.....	33
6. Ascending pathways.....	38
7. Sexual dimorphism of pain perception	40
2. TRP channels in somatosensory perception.....	44
1. General traits of TRP channels.....	44
2. TRPA1.....	50
3. TRPM8.....	54
3. Migraine.....	57
4. Epidemiology	58
5. Pathogenesis of migraine.....	59
6. Pathophysiology of migraine.....	61
7. Trigeminal sensitization in migraine.....	62
8. Main migraine treatments.....	66
9. Migraine sexual dimorphism.....	66
10. Models for the study of migraine.....	67
Objectives	70
1. General Objectives.....	70
2. Specific objectives.....	70

RESULTS	72
1. Characterization of the migraine model	72
1. Repeated nitroglycerin treatment induces a persistent hypersensitivity exclusively expressed in female mice.....	72
2. The oestrous cycle does not produce overt modifications in nitroglycerin-induced mechanical hypersensitivity.....	75
3. Chronic nitroglycerin treatment produced adrenal gland enlargement more prominent in females.....	77
2. Role of TRPA1 in Chronic Migraine Model	79
1. TRPA1 is essential for acute and chronic nitroglycerin sensitization	79
2. TRPA1 is a fast nitroglycerin responder	80
3. TRPA1 expression and activity is increased in trigeminal ganglia after nitroglycerin treatment.....	82
3. Nitroglycerin mediates CGRP release	87
4. Role of TRPV1 in the migraine model.....	91
1. Nitroglycerin treatment did not produce TRPV1 increased functionality.....	91
2. Acute Nitroglycerin does not potentiate TRPV1 activity <i>in-vitro</i>	92
3. Nitroglycerin treatment did not produce increased <i>in-vitro</i> potentiation of TRPV1.....	94
5. Role of TRPM8 in the migraine model	95
1. TRPM8 activity determines the recovery of normal sensitivity in male mice	95
2. Trigeminal TRPM8 does not present differences between sexes	96
3. Trpm8 activity shows antinociceptive effect in wild-type mice subjected to the nitroglycerin model of chronic migraine.....	99
4. TRPM8 has potential analgesic effect in another TRPA1-dependent pain model.....	102
5. Role of testosterone in the model of migraine	105

1. Testosterone relieves mechanical sensitization in male mice exposed to nitroglycerin.....	105
2. TRPM8-testosterone interaction participates in the male recovery.....	106
3. Testosterone elicits TRPM8-mediated calcium transients.....	109
6. Human vs mouse translatability.....	111
DISCUSSION	114
1. TRPA1.....	114
2. TRPV1	116
3. CGRP.....	117
4. TRPM8.....	119
5. Testosterone.....	121
6. Translatability of our results and pharmacological applications	124
7. Summary.....	125
Conclusions	128
Materials and methods	132
1. Animals.....	132
1. Drugs for behavioural studies.....	132
2. Genotyping	133
3. Chronic migraine model induced by nitroglycerin.....	134
4. Assessment of mechanical sensitivity.....	134
5. Formalin test.....	135
6. Orhidectomy.....	136
7. Testosterone Replacement Treatment.....	136
8. Estrous cycle determination.....	137
9. Measurement of the adrenal glands	138
2. Cellular experiments.....	139
1. Drugs for in-vitro studies.....	139
2. Trigeminal ganglion culture.....	139

3. Calcium imaging	140
4. CGRP Release.....	141
5. Hek cultures.....	142
6. RNA preparation and RTqPCR	143
3. Statistical analysis.....	144
References	147
ANEXO	174

ABBREVIATIONS

<i>CGRP</i>	<i>Calcitonin gene-related peptide</i>
<i>5-HT</i>	<i>Serotonin</i>
<i>AC</i>	<i>Adenylate cyclase</i>
<i>AITC</i>	<i>Allyl isothiocyanate</i>
<i>AMPA</i>	<i>α-amino-3-hydroxy-5-methyl-4-isoxazolepropionic acid</i>
<i>ANOVA</i>	<i>Analysis of variance</i>
<i>Arac. Acid</i>	<i>Arachidonic Acid</i>
<i>ASIC</i>	<i>Acid sensing ion channel receptors</i>
<i>ATP</i>	<i>Adenosine tri phosphate</i>
<i>BDNF</i>	<i>Nerve growth factor</i>
<i>BK</i>	<i>Bradykinin</i>
<i>CaM</i>	<i>Calcium calmodulin</i>
<i>CaMKII</i>	<i>Calmodulin kinase 2</i>
<i>cAMP</i>	<i>Cyclic adenosine monophosphate</i>
<i>CaV</i>	<i>Voltage gated calcium channel</i>
<i>CCL2</i>	<i>Phospholipase C</i>
<i>CGRP</i>	<i>Calcitonin gene related peptide</i>
<i>CGRPR</i>	<i>Calcitonin Gene Related Peptide Receptor</i>
<i>CNS</i>	<i>Central nervous system</i>
<i>COX</i>	<i>Cyclooxygenase</i>
<i>CREB</i>	<i>cAMP response element-binding protein</i>
<i>CSD</i>	<i>Cortical spread depression</i>
<i>DAG</i>	<i>Diacylglycerol</i>
<i>DAPI</i>	<i>4',6-diamidino-2-phenylindole</i>
<i>DMEM</i>	<i>Dulbecco's Modified Eagle Medium</i>
<i>DMSO</i>	<i>Dimethyl sulfoxide</i>
<i>DNA</i>	<i>Deoxyribonucleic acid</i>

dNTP Deoxyribose triphosphate
DRG Dorsal Root Ganglia
EPAC exchange factor directly activated by cAMP
ERK Extracellular signal-regulated kinase
FBS Foetal Bovine Serum
FDA Food and drug administration
GABA Gamma amino butyric acid
GDNF Glial cell-derived neurotrophic facto
Glut Glutamate
Gly Glycine
GPCRi G-protein coupled receptor inhibitor
GPCRs G protein–coupled receptors
HBSS Hanks balanced salt solution
HEK Human embryonic kidney
HEPES 4-(2-hydroxyethyl)-1-piperazineethanesulfonic acid
Hist Histamine
i.p. Intra peritoneal
IASP International Association for the Study of Pain
IB4 Isolectin B4
IL Interleukin
IMR90 Human Foetal Lung Fibroblasts
IP3 Inositol trisphosphate
K2P Two pore domain potassium channels
KO Knock out
KOR Kappa opioid receptor
LDCV Large dense core vesicles
LPS Lipopolysaccharide
MAP2 Microtubule Associated Protein 2

MAPK *Mitogen activated protein kinase*
MEM *Modified Eagle Medium*
mGluR *Metabotropic glutamate receptor*
MOR *Mu opioid receptor*
mRNA *Messenger ribonucleic acid*
NaV *Voltage gated sodium channel*
NGF *Nerve growth factor*
NMDA *N-methyl-D-aspartate*
NO *Nitric oxide*
NOS *Nitric oxide synthase*
NOx *Nitrogen oxides*
NTG *Nitroglycerin*
P2X *ATP-gated P2X receptor cation channels*
P2Y *ATP G protein-coupled receptors*
PAG *Periaqueductal grey*
PBS *Phosphate-buffered saline*
PCR *Polymerase chain reaction*
PGE2 *Prostaglandin E2*
PIP2 *Phosphatidylinositol 4,5-bisphosphate*
PKC/A *Adenylate cyclase*
PLC *Protein Kinase A/C*
qPCR *Quantitative polymerase chain reaction*
RAPM1 *Receptor activity modifying protein 1*
REDOX *Reduction oxidation*
RMV *Rostral ventromedial medulla*
RNA *Ribonucleic acid*
ROS *Reactive oxidative species*
RT-qPCR *Reverse transcription quantitative polymerase chain reaction*

<i>SD</i>	<i>Standard deviation</i>
<i>SEM</i>	<i>Standard error of the mean</i>
<i>SGCs</i>	<i>Satellite glial cells</i>
<i>SNAP-25</i>	<i>Synaptosomal-Associated Protein, 25kDa (</i>
<i>SNARE</i>	<i>Snap receptor</i>
<i>SP</i>	<i>Substance P</i>
<i>Testos</i>	<i>Testosterone</i>
<i>TG</i>	<i>Trigeminal ganglia</i>
<i>TLR4</i>	<i>Toll like receptor 4</i>
<i>TNF</i>	<i>Tumour necrosis factor</i>
<i>TRAAK</i>	<i>Potassium channel subfamily K member 4</i>
<i>TREK</i>	<i>Potassium channel subfamily K member 2 is</i>
<i>TRPA</i>	<i>Transient receptor potential ankyrin</i>
<i>TRPA1</i>	<i>Transient receptor potential ankyrin 1</i>
<i>TRPC</i>	<i>Transient receptor potential canonical</i>
<i>TRPM</i>	<i>Transient receptor potential melastatin</i>
<i>TRPM3</i>	<i>Transient receptor melastatin 3</i>
<i>TRPM8</i>	<i>Transient receptor potential melastatin 8</i>
<i>TRPML</i>	<i>Transient receptor potential mucolipin</i>
<i>TRPP</i>	<i>Transient receptor potential polycystic</i>
<i>TRPs</i>	<i>Transient receptor potential channels</i>
<i>TRPV</i>	<i>Transient receptor potential vanilloid</i>
<i>TRPV1</i>	<i>Transient receptor potential vanilloid 1</i>
<i>Veh</i>	<i>Vehicle</i>
<i>WT</i>	<i>Wild-type</i>

ABSTRACT

Chronic pain strongly deteriorates quality of life and lacks adequate treatment, the impact of chronic pain is especially crude in women originating inequality in pain assessment and treatment. We chose a model of chronic migraine to study the effect of sex in pain chronification, as migraine is considered a chronic sensitization that presents a strong sexual dimorphism. We used in vitro and murine models to investigate the role of TRP channels and neuropeptide CGRP in the sexual dimorphism of this chronic pain model. The model of chronic migraine was established by repeated intraperitoneal injections of nitroglycerin in male and female C57BL/6J adult mice. We used mechanical sensitivity measurements by Von Frey filaments to monitor sensory hypersensitivity of mice under chronic nitroglycerin administration. To study the role of TRPA1, TRPM8 and CGRP in model, we used knockout mice and pharmacological tools. We further studied the activity of these genes by calcium imaging and their expression by qPCR in trigeminal neurons and cell lines expressing the murine and human receptors. Finally, CGRP release was assessed by immunocytochemistry. The chronic migraine model was characterized by a stronger chronification process in females. Furthermore, CGRP knockout mice or treated with a CGRP exocytosis inhibitor did not develop chronic pain. We found out that TRPA1 is essential for nitroglycerin sensitization of the animals as it functions as a nitroglycerin receptor, and this activation produced the CGRP release from trigeminal neurons. TRPM8 did present differential activity in-vivo attending to the sex, playing a protective role in male mice that was testosterone-dependent. In-vitro experiments could corroborate the agonistic activity of testosterone over TRPM8. In summary, we present a migraine model based on nitroglycerin administration that shares characteristics with migraine in humans, as it presents stronger effect in female animals and is CGRP dependent. We described TRPA1 as the main trigger of hypersensitivity through CGRP release, while TRPM8 had a protective effect that was sex dependent, counterbalancing hypersensitivity exclusively in males. Finally, we propose that TRPM8 activation in males by testosterone overrides chronic sensitization produced by nitroglycerin administration.

RESUMEN

El dolor crónico deteriora fuertemente la calidad de vida y en muchos casos carece de tratamiento adecuado. El impacto del dolor crónico es especialmente crudo en mujeres, siendo origen de desigualdad en la identificación y tratamiento del dolor. Para estudiar el efecto del sexo en la cronificación del dolor se seleccionó un modelo de migraña crónica, porque la migraña es considerada una sensibilización crónica que presenta un fuerte dimorfismo sexual. En este trabajo, usamos un modelo de migraña en animales y aproximaciones in-vitro, para investigar el rol de canales TRP y el neuropéptido CGRP en el dimorfismo sexual de éste modelo de migraña crónica. El modelo se establece por la inyección repetida de nitroglicerina en ratones C57BL/6J adultos de ambos sexos. Se midió la sensibilidad mecánica con filamentos de Von Frey para monitorizar la hipersensibilidad sensorial que acompaña a la administración crónica de nitroglicerina. Para estudiar la función de TRPA1, TRPM8 y CGRP se usaron herramientas génicas y farmacológicas. Además, estudiamos la actividad de estos genes mediante imagen de calcio y su expresión mediante qPCR en neuronas del trigémino y líneas celulares. Finalmente, estudiamos la liberación de CGRP mediante marcaje con anticuerpos fluorescentes. El modelo de migraña crónica se caracteriza por una cronificación más severa en hembras que en machos. Además, animales deficientes para CGRP o tratados con un inhibidor de su exocitosis no desarrollaron sensibilización crónica. Encontramos que TRPA1 es esencial para la sensibilización crónica, dado que funciona como un receptor de nitroglicerina y media la liberación de CGRP. TRPM8 presentó actividad diferencial in-vivo dependiendo del sexo, jugando un papel protector en machos que fue dependiente de testosterona. En concordancia, experimentos in-vitro mostraron actividad agonista de testosterona sobre TRPM8. En resumen, presentamos un modelo de migraña basado en la administración de nitroglicerina que comparte características con la migraña en humanos, ya que presenta un efecto más potente en hembras, y es dependiente de CGRP. Describimos a TRPA1 como el principal disparador de la hipersensibilidad, mediada por la liberación de CGRP. Mientras que TRPM8 jugó un papel protector solo en machos. Finalmente, proponemos que la activación de TRPM8 por testosterona en machos sobrescribe la sensibilización producida por nitroglicerina.

INTRODUCTION

*I-I-I've got a migraine
And my pain will range from
Up down and sideways
'Cause Fridays will always
Be better than Sundays
'Cause Sundays are my suicide days
-Twenty-one Pilots; Migraine*

INTRODUCTION

1. PAIN

1. PAIN CONCEPT AND CLASSIFICATION

Pain is defined by the International Association for the Study of Pain (IASP) as “**an unpleasant sensory and emotional experience associated with, or resembling that associated with, actual or potential tissue damage**”¹. Medical definition for pain has evolved^{2,3}, becoming more complex while it aligned itself with growing knowledge about the different components of pain. The latest pain definition³, observes the subjective and emotional response to pain, highlighting the relevance of the personal experience and taking in consideration that tissue damage is not needed for pain sensation. Thus, it is more inclusive with people suffering from pain types with no clear cause nor visible effect, and with patients or non-human animals that can not explicitly express their pain.

Of special interest for this work is the distinction between acute and chronic pain. Acute pain usually appears in response to a specific cause and presents a sharp quality. It disappears when there is no longer an underlying cause for the pain. **Chronic Pain** is characterised by a **persistent sensitization** produced by ongoing inflammatory or neuropathic damage, characteristically chronic pain can persist even when the original cause has already healed or been medically addressed⁴. Persistent pain severely hinders quality of life⁵, being ranked as one of the most important health burdens in developed countries^{5,6,7,8}. Chronic pain also has a remarkable economic impact, because it reduces labour productivity, propitiates absenteeism and long-term disability⁹, costing USA US\$7.1 billion annually⁵. Its global impact is growing due to its connection with rising risk factors, such as an aging population, obesity and pollutants^{4,10-13}. Despite its importance, many chronic pain conditions still **lack adequate treatment**¹⁴⁻¹⁶, which in many cases require the use of opioids. The use of opioids for long term treatments presents

strong limitations due to reduced long-term efficacy, as well as risks of tolerance and dependence, misuse and overdose mortality.^{9,17} Thus, further knowledge of the pain alterations is vital for the development of finer and more precise non-opioid interventions against mechanisms of pain chronification.

2. THE SOMATOSENSORY SYSTEM

Pain perception as a sensory modality, rises from the activation of a specific branch of the somatosensory nervous system. The peripheral **somatosensory nervous system** collects sensory information (including noxious stimuli) from an array of diverse **sensory receptors** distributed throughout the body, and transmits this information to the central nervous system where information is integrated¹⁸. The first component of the somatosensory pathways are the **primary afferent neurons**, whose somas are located in the dorsal root ganglia (DRG) or the trigeminal ganglia (TG). Fibres projecting from DRG form the nerves that innervate the body, neck and posterior part of the head, while trigeminal fibres innervate the anterior portion of the head and meninges. These neurons present pseudo-unipolar morphology; from the soma extends one axon that divides into two branches. The peripheral branch reaches and innervates peripheral tissues whereas the central terminal establishes synapses with second order neurons in the central nervous system^{18,19} (**Figure 1**).

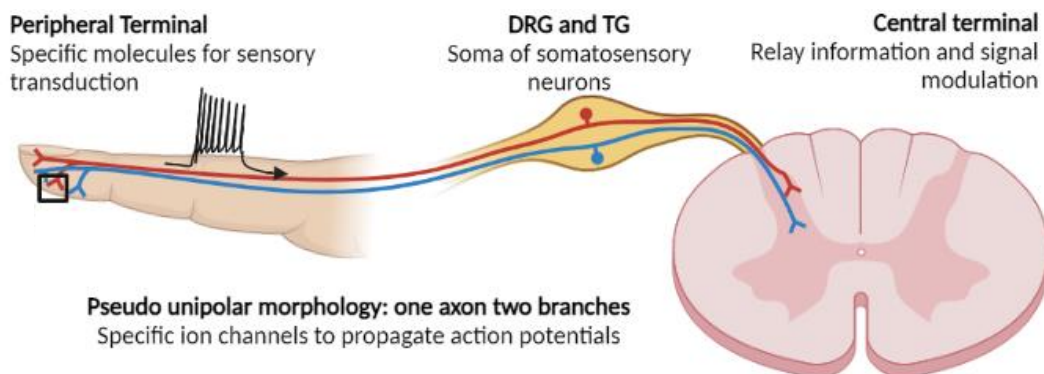

Figure 1 Primary sensory neurons present a bifurcated axon with one branch innervating peripheral tissues and the other one reaching the central nervous system. The peripheral terminal

transduces stimuli into cellular electrical signals that propagate towards the spinal cord in the form of action potentials. **Drawings made with Biorender™ tool.**

Sensory neurons can be classified attending to properties of their fibres, i.e.; conduction velocity, myelination and thickness of the axon. They can also be classified regarding the type stimulus that elicits their activity, i.e.; thermal, mechanical and chemical and the intensity of the stimulus, high and low threshold. Finally, sensory neurons can be classified by the laminae of the dorsal horn where they make synapsis. Here we have confectioned a general classification attending to all the above cited characteristics (**Table 1**). Important to note, that functional roles assigned to each group is greatly simplified.

Table 1 General classification of sensory neurons

Fibre type	Aβ	Aδ	C
Conduction velocity (m/s)	36-72	4-36	0.4-2.0
Myelination	Thickly	Mildly	No
Fibre diameter (μM)	6-12	1-6	0.2-1.5
Sensory modality	Low threshold mechanoreceptors: touch	Low threshold mechanoreceptors: hair skin Low threshold thermoreceptors: pleasant temperature ranges. High threshold thermo- & mechanoreceptors, chemoreceptors: sharp pain	High threshold thermo- & mechanoreceptors, chemoreceptors: dull burning pain
Rexed laminae	IV	I, II, V	I, II

Primary sensory neurons respond selectively to specific types of sensory stimuli due to morphological and molecular specialization of their peripheral terminals. The codification of stimuli into transmissible neurological signals is known as **sensory transduction**²⁰ (**Figure 2A**). Transducing molecules can transform diverse types of chemical and physical stimuli into cellular signals, depending on the nature of the receptor, i.e.; ionotropic and metabotropic. Ionotropic receptors

are usually cationic ion channels (mainly permeable to calcium and sodium), which gating is regulated by incoming sensory stimuli. The depolarizing current produced by the opening of sensory transducers is called **generator potential** (**Figure 2B**). Metabotropic transducers produce second messenger signalling in response to activation by sensory stimuli, these second messengers regulate the activity of ionotropic receptors, and control other systems of the somatosensory neuron. The depolarization produced by the generator potential is conditioned by the strength of the stimulus and the sensitivity of the terminal (number and activity of the receptors), if the generator potential reaches the action potential threshold, the terminal will fire **action potentials** that can travel through the fibres to the central nervous system (**Figure 2B**). Finally, the threshold of the action potential is determined by the properties of the voltage gated sodium and calcium channels, which participate in the generation of the action potential. The intensity of the stimulus can be codified into the frequency of action potentials fired; stronger stimuli might produce higher frequency.

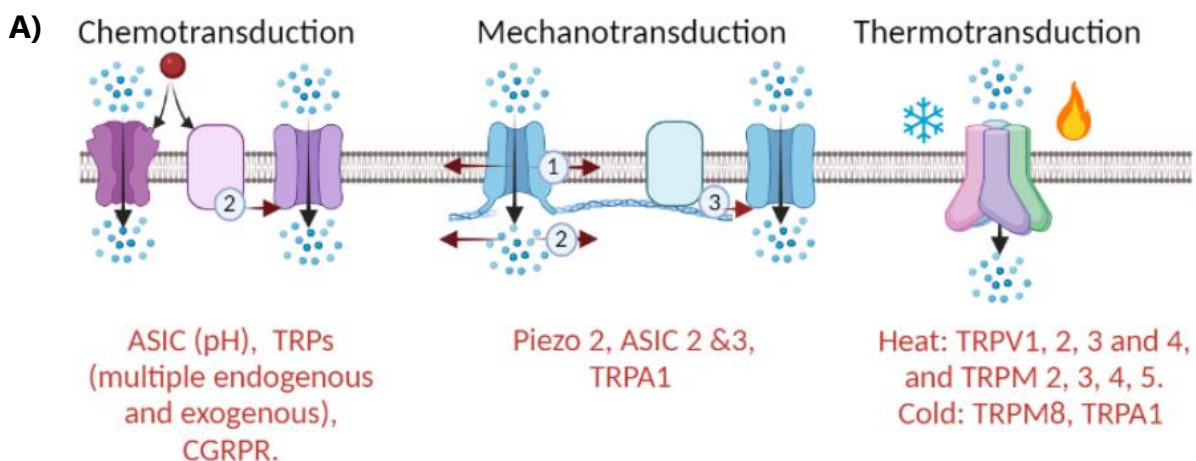

Figure 2 Sensory nerve terminal and mechanisms of transduction. **A)** Chemical stimuli produce an activation by electrochemical interaction with the protein receptors, producing conformational changes that activate it. **Mechanical** transduction is believed to happen by transference of mechanical force from the membrane or structural proteins like cytoskeleton to the receptor by tethering structures. **Thermal** transduction is thought to work by folding regulation of specific temperature-sensitive structures that modulate the activity of the receptor. **Drawings made with Biorender™ tool. (Continued in next page)**

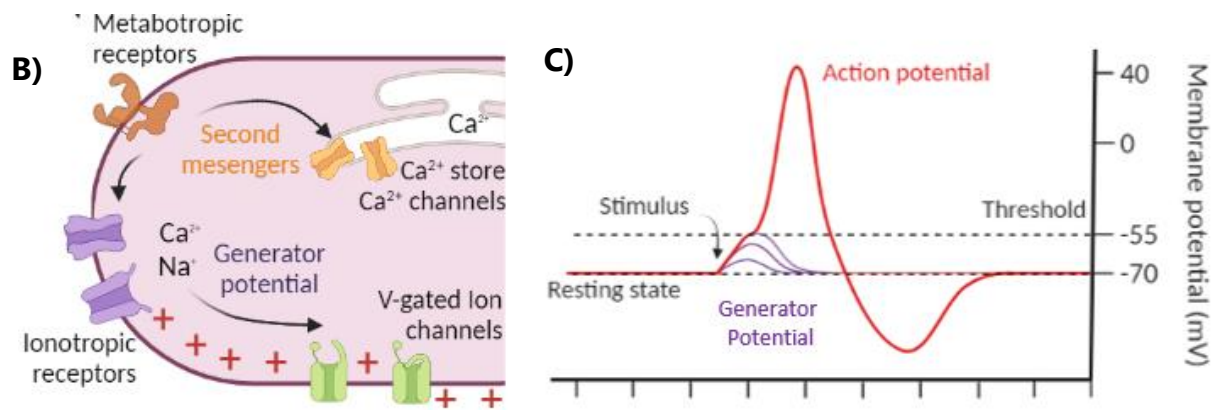

Figure 2 Sensory nerve terminal and mechanisms of transduction. B) Sensory terminal transduction. Ionotropic and metabotropic receptors transduce sensory stimuli into second messenger and electrochemical signalling. If depolarisation is strong enough voltage gated ion channels can be recruited producing action potentials. Second messengers like calcium can produce vesicle exocytosis and calcium induced-calcium release from endoplasmic reticulum. Important to note that many sensory neurons express a diversity of transducer molecules, granting polysensory sensitivity. **C) Receptor potential.** Sensory stimuli initiate depolarisation known as generator potential, stimuli of enough strength elicit action potentials. *Drawings made with Biorender™ tool.*

Action potentials produced in the sensory terminal are **transmitted** through the axon to the soma of the cell. The electrochemical signal reaches the dorsal horn of the spinal cord (dorsal root ganglia) or the brainstem (trigeminal ganglia), where the information is passed to a **second order neuron** in the first synapse of the somatosensory pathway (**Figure 4A**). Incoming action potentials and calcium waves produce an increase of calcium in the central terminal of the somatosensory neuron. Increased calcium levels produce exocytosis of neurotransmitter-containing vesicles and neurotransmitter release (mainly glutamate). Glutamate then crosses the synaptic cleft and binds to its NMDA ((2R)-2-(Methylamino) butanedioic acid) and AMPA (2-Amino-3-(3-hydroxy-5-methyl-isoxazol-4-yl) propanoic acid) receptors, inducing depolarisation in the second order neuron, which action potentials will send information to the encephalon.

Each sensory modality establishes synapses in a specific layer (Rexed Lamina) in the dorsal horn of the spinal cord **Table 1**. Second order neurons from each lamina group and form sensory-specific tracts and conduct information to high order processing regions of the central nervous system. Lamina I, II and V receive information from noxious stimuli and temperature and project through the lateral tracts, lamina III and IV convey position and light touch sense through the dorsal columns and ventral spinothalamic tract (**Figure 4B**). Dorsal horn is not only a relay post for information transmission, there are also connectivity circuits capable of information processing. For example, polysynaptic transmission of sensory afferents allow for interferences between sensory types, residing interneurons (i.e.; GABAergic and glycinergic) and descending efferents from central modulatory systems regulate excitability and glial cells modulate neurotransmission.

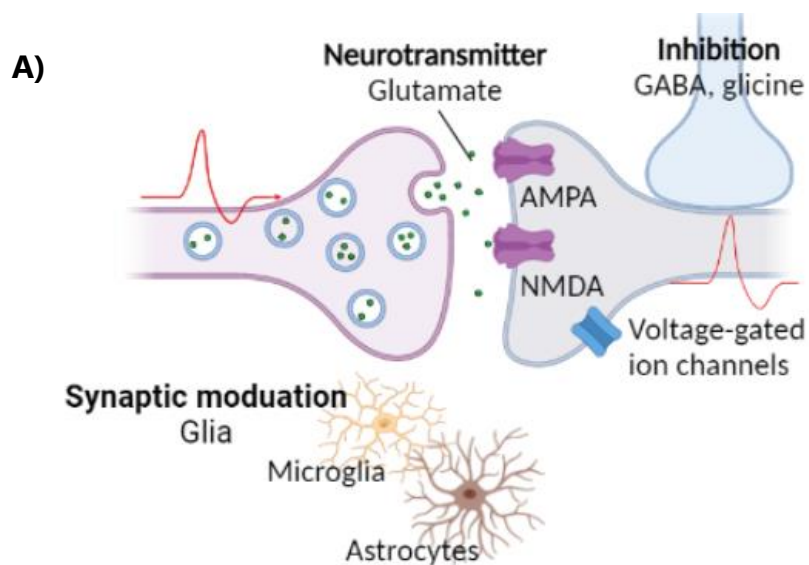

Figure 3 Sensory transmission to the central nervous system. A) The principal neurotransmitter involved is glutamate, which activates AMPA (α -amino-3-hidroxi-5-metilo-4-isoxazolpropionic acid) and NMDA (N-Methyl-D-aspartic acid) glutamate receptors in the secondary neuron eliciting postsynaptic potentials. *Self-made drawings with Biorender Tool. (Continued in next page)*

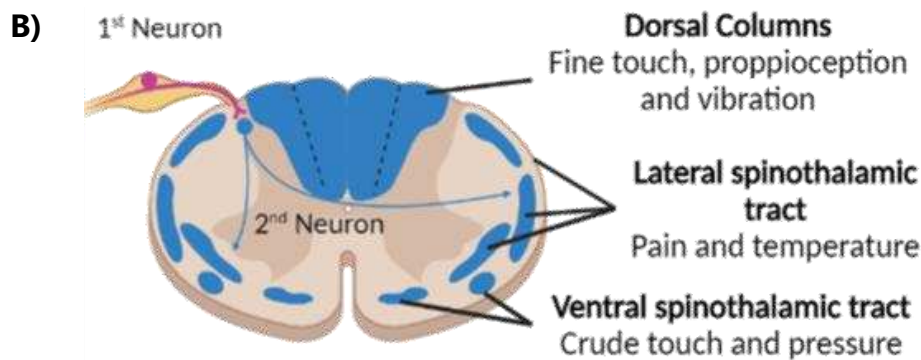

Figure 4 Sensory transmission to the central nervous system. B) Somatosensory neurons of sensory modality establish synapses with the second neuron in a specific layer of the dorsal horn. Each sensory modality ascends to higher order central systems forming specific tracts. *Self-made drawings with Biorender Tool.*

Information enters the encephalon through the midbrain, as the secondary sensory neurons establish synapses with thalamic nuclei. From the thalamus, somatosensory information is distributed to specialised areas of the brain that compute the diverse components of the sensation. For example, the somatosensory cortex participates in the spatial localization, while the amygdala and insula assign the emotional value and the hippocampus and cerebellum contribute with memory and context information.

3. NOCICEPTOR CLASSIFICATION

Nociceptors are currently defined as “a high-threshold sensory receptors of the peripheral somatosensory nervous system that are capable of transducing and encoding noxious stimuli”²¹. The neural process of encoding noxious stimuli is known as **nociception**, which can produce autonomic (e. g. tachycardia) or behavioural responses (motor withdrawal reflex or complex nocifensive behaviour). Nociceptors can be classified according to their size, the myelination and conduction velocity of their axons, the place of the spinal cord where they establish contact, their sensitivity to temperature or mechanical forces and by their ability to secrete neuropeptides^{18,19,22-26} (**Figure 5**). On the basis of

degree of myelination and the speed at which action potentials travel along afferent fibres, the nociceptors can be classified in:

A δ fibres are the nociceptors responsible for the first sharp pain sensation which allows for precise anatomical localization of pain. This group of nociceptors present lightly myelinated axons with medium diameter (5 μ m) granting a conduction velocity of at least 30 m/s. Sensory information from A δ nociceptors is transmitted through synapses in laminae I and V of the spinal cord. These nociceptors can be generally classified into two main groups.

A δ 1 nociceptors are sensitive to high mechanical forces and present a very high threshold for temperatures higher than 50 °C. There is a subgroup inside the **A δ 1** nociceptors that can respond to cold temperatures, lower than 15°C.

A δ 2 nociceptors are more sensitive to temperature, being activated at 42°C or higher temperature and only sense mechanical forces in extreme ranges of intensity.

C fibres are in charge of a slower dull pain, which is felt some time (from seconds to minutes) after the onset of the origin of the damage, the pain perception produced by C fibres doesn't present good spatial localization. These nociceptors present non-myelinated axons of small diameter (1 μ m) with slow conduction velocity (1 m/s) and establish synapsis with laminae I and II of the spinal cord. Functionally, C nociceptors can be thermosensitive, mechanosensitive, chemosensitive and polymodal. There is a subpopulation that presents a specialized set of vesicles called large dense core vesicles (LDCV) in their central and peripheral terminals. These nociceptors are called **peptidergic nociceptors**, as these vesicles contain

neuroinflammatory peptides including CGRP (calcitonin gene-related peptide) and SP (substance P). These cells express trkA, the nerve growth factor receptor and can't be labelled by IB4 (isolectin B4).

***A β** fibres, in pathological conditions can contribute to nociception.

Canonical classification attending to the soma and axonal size²⁷, myelination and conduction velocity¹⁶ is limited. Classification of A δ and C nociceptors fails to predict functional properties, as an example, not all the non-myelinated small somatosensory neurons are nociceptors¹⁶. Thus, functional classification of nociceptors is enriched by the growing knowledge of molecular transducers expression, in the next section we talk about the main groups of these important molecules.

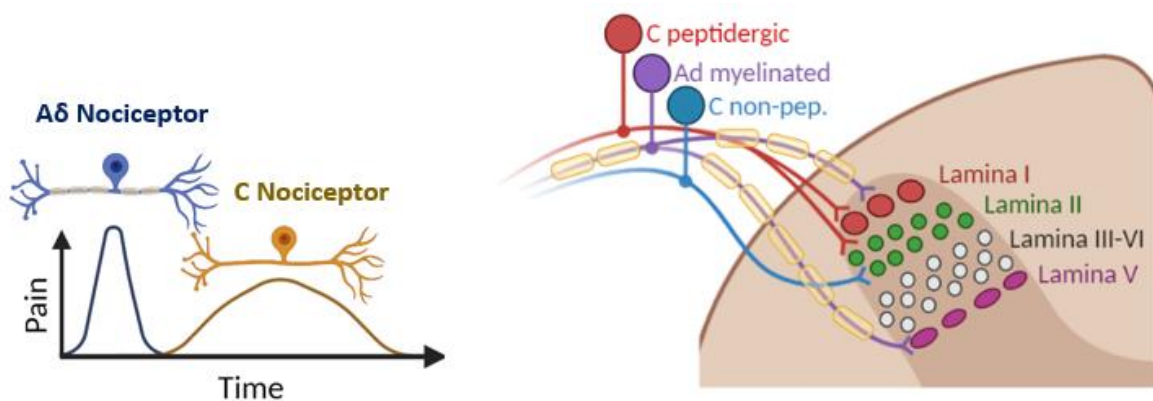

Figure 5 Types of nociceptors. A) Conduction velocity. Painful stimuli usually present two phases because of the differences in conduction velocity of the action potential, the first sharp and well localized pain is transmitted by A δ myelinated nociceptors, while the second dull and diffuse pain is signalled by C type unmyelinated nociceptors. **B) Spinal connectivity.** A δ Nociceptors that carry the first pain connect with the laminae I and V of the dorsal spinal horn, C nociceptors establish synapses with laminae I and II. *Drawings self-made with BiorenderTM tool.*

4. THE NOCICEPTOR FUNCTION

Molecules responsible for pain transduction can be classified in three main groups: ion channels, metabotropic G protein-coupled receptors (GPCRs), and receptors for neurotrophins or cytokines (**Figure 6**). **Ion channels** can **transduce noxious stimuli** into a **generator potential** in the nociceptor terminal. Transient receptor potential channels (**TRP**) constitute notable transducers since these cationic ion channels allow for sensitivity to exogenous and endogenous chemicals, they can be activated by temperature changes and mechanical stress like pressure²⁸. The first TRP described was the capsaicin receptor TRPV1, which can also be activated by high temperatures, pH, voltage and inflammatory mediator arachidonic acid. The cold receptor TRPM8 is a notable member of the TRP family, which can also be activated by menthol and other cooling agents. Acid sensing ion channel receptors (**ASIC**) permeate mainly sodium in response to modifications of the pH²⁹. The **P2X** (ATP-gated P2X receptor cation channel family) receptors form cation-permeable channels that can be activated by ATP, a common mediator released by injured cells³⁰.

Nociceptors also express specific ion channels in charge of generating the **action potential**. The rapid depolarisation of the action potential is produced by voltage-gated sodium channels **Nav 1.7, 1.8 and 1.9**³¹. Their activity can be modulated by noxious stimuli, for example Nav 1.7 and Nav 1.8 are overexpressed in chronic pain models like postsurgical³², colonic diabetic pain³³ and nerve lesion³⁴. Suppression of their activity with antibodies³⁵ and control of their overexpression with α -lipoid acid³⁶ prevents pain sensitization. Voltage gated calcium channels also play a role in the electrical response of nociceptors, like low-threshold or T-type voltage-gated calcium channels. Nociceptors are a type of sensory neuron specially silent in absence of stimulus³⁷, thanks to a large potassium conductance determined by the types of voltage-gated³⁸ and voltage-insensitive potassium channels³⁹. Especially important in nociceptors are the **K2P**

(two pore domain, or background leak), **TRAAK** (potassium channel subfamily K member 4) and **TREK** (two pore domain potassium channel) channels, which are not mere passive hyperpolarizing conductance, as their activity is influenced by lipidic agonists, temperature and mechanical forces⁴⁰⁻⁴³, adapting the nociceptors excitability to the situation.

Activation of ion channel receptors leads to a rapid activation of the nociceptor terminal, but there are membrane receptors whose activation modulate the function of the nociceptor, including G-protein coupled receptors (GPCRs), neurotrophin and cytokine receptors. **GPCRs** play a key role in modulating sensitivity of the nociceptor terminal. These receptors modulate the sensitivity of ion channels through second messenger cascades^{44,45}. Some GPCRs are excitatory including **serotonin**, **bradykinin**, **prostaglandin** and **CGRP** receptors⁴⁶. These receptors increase the activity of transducing molecules or the generation of action potentials. For example, bradykinin receptor recruits adenylate cyclase, the increased cAMP activates protein kinase A, which phosphorylates TRPA1 and TRPV1 and makes them more active, while decrease TRPM8 activity. Bradykinin receptor activation also recruits phospholipase C, which degrades PIP2 (a TRPV1/A1 inhibitor) into diacyl glycerol (DAG) and inositol triphosphate (IP3). DAG activates protein kinase C, which also phosphorylates TRPs and increases their activity, while IP3 produces calcium release from intracellular stores and sensitizes TRPA1 and voltage gated calcium dependent channels⁴⁷ (**Figure 17**). On the other hand, there are inhibitor GPCRs, like the **opioid or cannabinoid receptors**⁴⁸. As a counterpart of excitatory GPCRs, these receptors are coupled to inhibitory g-proteins. Finally, **Neurotrophin**⁴⁹ and **cytokine**^{50,51} receptors have similar roles as the excitatory GPCRs¹⁶, and mainly increase the activity of the nociceptor terminal and promote neurogenic tropism, increasing terminal branching and length. These systems modulate the excitability of the nociceptor and can participate in their **sensitization**.

Nociceptor peripheral terminal: free nerve ending

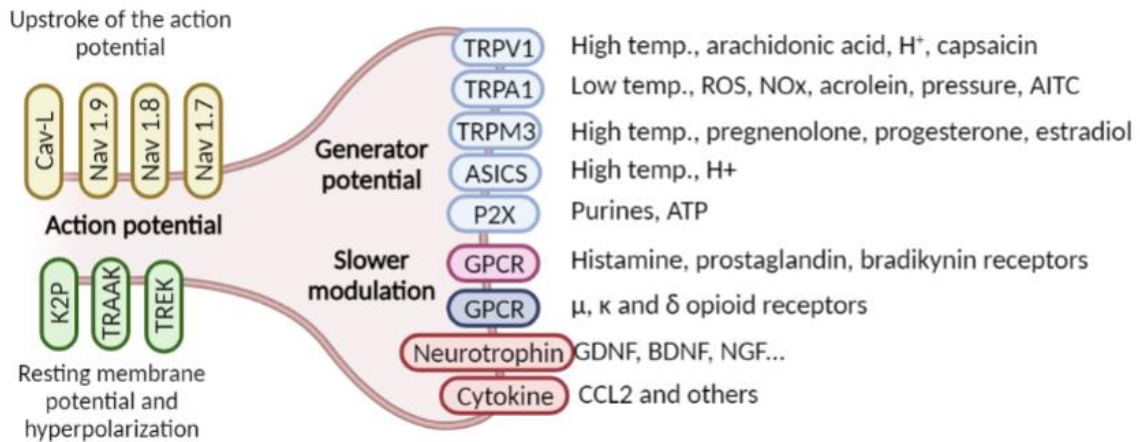

Figure 6 The nociceptor terminal. Representation of a free nociceptor terminal and important molecules for pain transduction. In **light blue**: important receptors forming ion channels which activation conduces to the opening of depolarizing calcium and sodium currents, also known as generator potential. In **ochre**: main voltage gated sodium and ion channels that are activated in response to depolarization produced by the generator potential, these voltage-gated ion channels establish the threshold for action potential generation. In **green**: potassium currents responsible for hyperpolarizing conductance that maintain the resting membrane potential in negative values and that also participate in the down stroke of the action potential. In **magenta**: excitatory G Protein Coupled Receptors (GPCR), which produce excitatory second messenger signalling, they recruit PLC (phospholipase C), PKC/A (Protein Kinase A/C), AC (adenylate cyclase), which induce postraductional changes in ion channels that increase excitability, produce calcium release from intracellular storages and start nuclear signalling pathways for gene expression modulation. In **dark blue**: opioid receptors in general are coupled with inhibitory G proteins, which effects include internalization and postraductional changes of ion channels that decrease excitability, and also start nuclear signalling pathways that modulate gene expression. Finally, in **red**: neurotrophin and cytokine receptors, are known sensitizers of nociceptors, which effects are similar to excitatory GPCR, but with additional effects such as axonal regrowth trophic factors and formation of additional spindles. **Drawings made with Biorender™ tool.**

As in the other somatosensory modalities, central branch of the nociceptors establishes synaptic communication with second order neuron in the dorsal horn. As explained in **Figure 5**, each type of nociceptor relays information to a determined Rexed Lamina. Synapsis of nociceptive pathways have some special features that allow for central sensitization processes and modulations of its

function. Apart from glutamate neurotransmitter vesicles, nociceptors can release inflammatory substances ATP, SP and CGRP into the synaptic surroundings²⁰. These sensitizing substances recruit glial cells such as astrocytes and microglia. There is also expression of CGRP and ATP receptors in the pre and post synaptic terminals, as well as other receptors for sensitizing molecules such as BDNF⁵².

Pain perception is the consequence of a balance of the activity of nociceptive and non-nociceptive afferents. It has been described that **mechano-transducing** pathways can modulate the transmission of nociceptive information to central processing areas. Ronald Melzack and Patrick Wall proposed the **gate theory of pain**, where non-painful stimuli could modulate pain transmission in the dorsal horn, through direct synapses or via interneurons. This theory has been extended to other sensory modalities, such as **temperature stimulation**, as it has been proven in humans that local cooling application in an injured area can stifle pain sensation⁵³⁻⁵⁵ **Figure 7**.

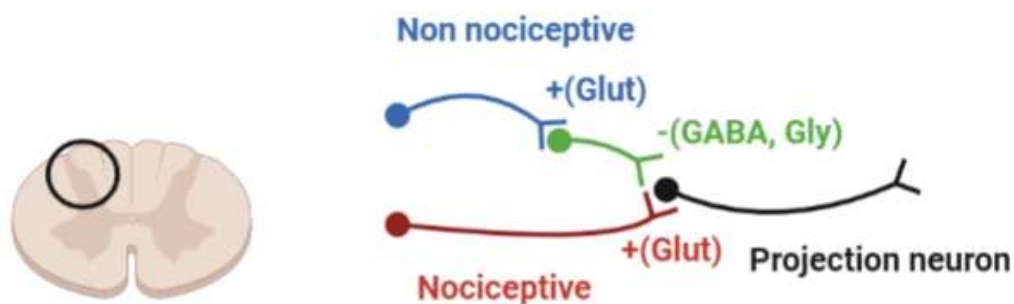

Figure 7 Gate theory of pain. Activation of non-noxious somatosensory neurons modulates the transmission of nociceptive information to higher centres, by directly inhibiting nociceptive fibres or by recruiting inhibitory GABAergic or glycinergic interneurons.

5. NOCICEPTOR SENSITISATION

Pain sensitization is behind the transition from an acute pain in response to a noxious stimulus into a chronic condition¹⁶. Sensitized nociceptors present lower thresholds to noxious stimuli⁵⁶ and increase their spontaneous activity¹⁶.

Peripheral sensitization (Figure 8) is achieved by the collaboration of nociceptors with cells in the innervated tissue (endothelial cells, keratinocytes and fibroblasts), blood cells recruited by inflammatory process (platelets, mast cells, basophils, macrophages and neutrophils), and glial cells (swan and satellite cells). All of these types of cells release a sensitizing mix of compounds that activate and modulate the molecular transducers¹⁶ (**Figure 6**). The main sensitizing substances include: protons, arachidonic acid, bradykinin, histamine, serotonin, prostaglandins, nucleotides, nerve growth factor, cytokines, TNF α , acrolein and nitric oxide.

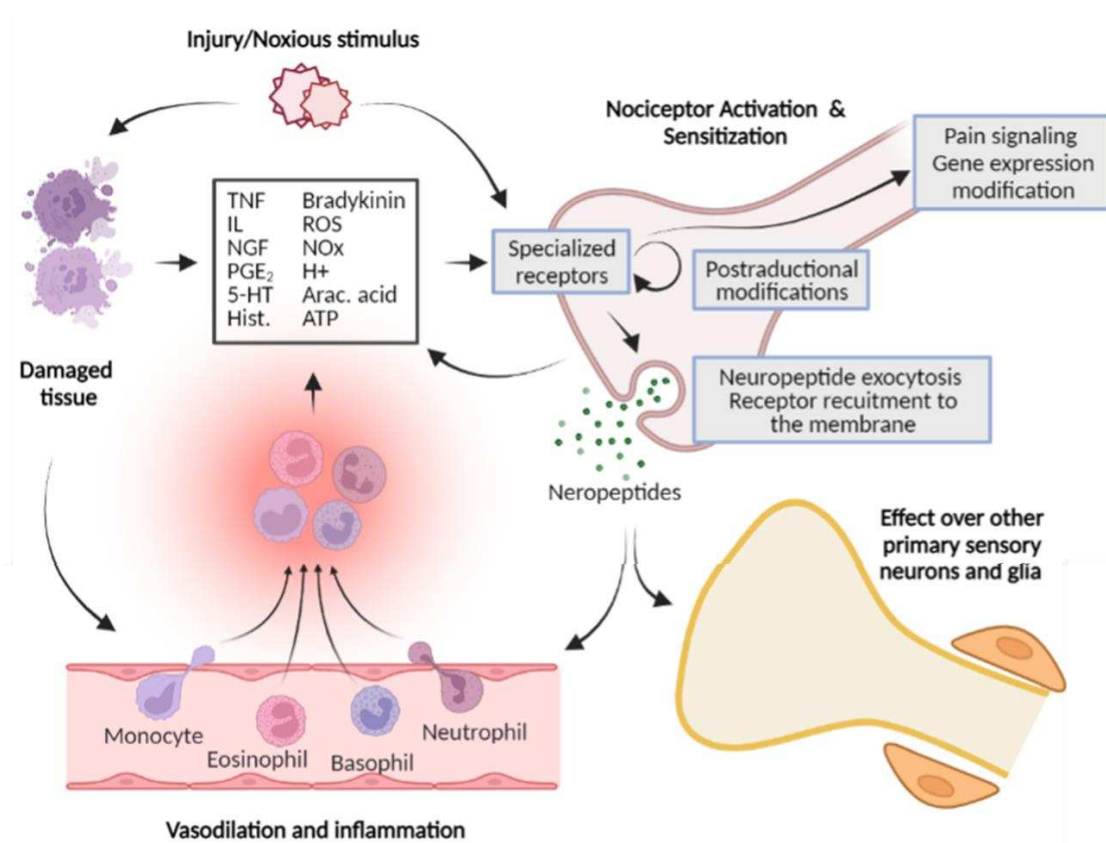

Figure 8 Peripheral mechanisms of nociceptor sensitization. Noxious stimuli can elicit a cascade of signalling that ends with a gain of function of nociceptors. There are two main sources of sensitizing factors: in first place damaged tissue releases sensitizing substances and recruits the inflammatory system that also contributes to the secretion of this sensitizing soup. The second source of sensitizing factors are the nociceptors themselves, which upon activation participate in the generation of the sensitizing soup, releasing neuroinflammatory peptides (CGRP and SP) and secrete NGF, NO_x and ATP. **Drawings made with BiorenderTM.**

These sensitizing substances can make their effect through many different ways (**Figure 17**), they can activate or modulate receptors and ion channels, i.e; upon tissue damage and inflammation arachidonic acid released by leucocytes directly activate TRPV1, while released protons activate ASIC⁵⁷ channels and sensitize TRPV1, making it more active in response to other stimuli⁵. Inflammatory response after tissue damage and especially after nerve lesion produces an increase of local reactive oxidative species that sensitize TRPA1 while nitric oxide released by glia and endothelial cells directly activates the ankyrin receptor⁵⁸. Finally, ATP released from damaged cells activates receptors P2X that form ion channels producing depolarizing currents. Sensitization of ion channel transducers can also happen in response to exogenous stimuli, for example TRPA1 can be sensitised by ozone and activated by acrolein⁵⁹ There are also indirect effects mediated by G-Protein coupled receptors (GPCRs) which initiate signalling cascades that increase receptor and ion channel activity, for example histamine and bradykinin receptors are coupled to phospholipase C (PLC) and increase activity of voltage-gated sodium channels and TRPs. Finally, sensitizing factors can also regulate gene expression, for example nerve growth factor (NGF) and tumour necrosis factor (TNF) receptors recruit adenylate cyclase (AC), protein kinase A (PKA) and mitogen-activated protein kinase (MAPK) which downregulate some potassium hyperpolarizing channels⁴⁰⁻⁴³, while upregulate certain NaV (voltage gated sodium channels) and TRP channels.

Nociceptors also participate in the secretion of sensitizing molecules, especially peptidergic C nociceptors, which release calcitonin gene-related peptide (CGRP), substance P, adenosine tri phosphate (ATP), and nitric oxide (NO) upon activation, these molecules produce vasodilation and inflammatory recruitment, producing what is known as **neurogenic inflammation**⁶⁰. This mechanism of sensitization is especially important in pain conditions like **migraine** and fibromyalgia, where tissue damage is not obvious, and it is the activation of abnormally sensitive

nociceptors what produces the release of more sensitizing factors forming a closed positive loop⁶¹.

Identifying components and mechanisms of the peripheral sensitization is a promising area for potential analgesic treatments avoiding the central nervous system. Knowledge of sensitization mechanisms has allowed for improvement of pain therapies, for example SP antagonists have shown efficacy in humans against inflammation and vasodilation, and NGF neutralizing molecules are effective agents in animal models of pain with a potency similar to COX inhibitors and opiates^{16,62}. Peripheral sensitization has been targeted in clinical trials with success⁶³. For instance, CGRP and CGRP receptor antibodies are delivering promising results for migraine treatment⁶⁴⁻⁶⁶ showing that sensitization can be a useful target⁵⁶, with some being clinically used at the moment⁶⁷.

However, peripheral sensitization alone does not fully account for the prolonged presence of pain, dynamic tactile allodynia, temporal summation of pain and the spread of pain hypersensitivity to non-injured tissue¹⁴. With persistent noxious stimulation central pain pathways suffer mechanisms of **long term potentiation**, including increased excitability and synaptic efficacy and loss of inhibitory activity from interneurons producing **central sensitisation**^{14,20}. Tonic stimulation of C nociceptors produces calcium build-up in the presynaptic terminal, which increases release of neurotransmitter glutamate and sensitizing factors CGRP, substance P and BDNF. There is an increase of postsynaptic glutamatergic (AMPA) activity which sums up with CGRP receptor, neurokinin1 (SP receptor) and BDNF signalling. The barrage of calcium accumulation in the postsynaptic terminal produces a release of the NMDA magnesium block increasing postsynaptic sensitivity to magnesium. Also, CGRP and SP receptor signalling potentiate the activity of glutamate receptors and voltage-gated ion channels responsible for the action potentials. Finally, microglia and astrocytes are activated by the

neuropeptides and BDNF, and secrete TNF and interleukins, which further participate in the postsynaptic sensitization as was explained previously. Persistent activation of C nociceptors can also reduce influence of inhibitory pathways; reducing glycinergic and GABAergic interneurons, recruited by non-nociceptive A β afferents and descending opioid system. There can even be formation of new synapsis between A β afferents and non-nociceptive pathways, producing hypersensitivity or allodynia.

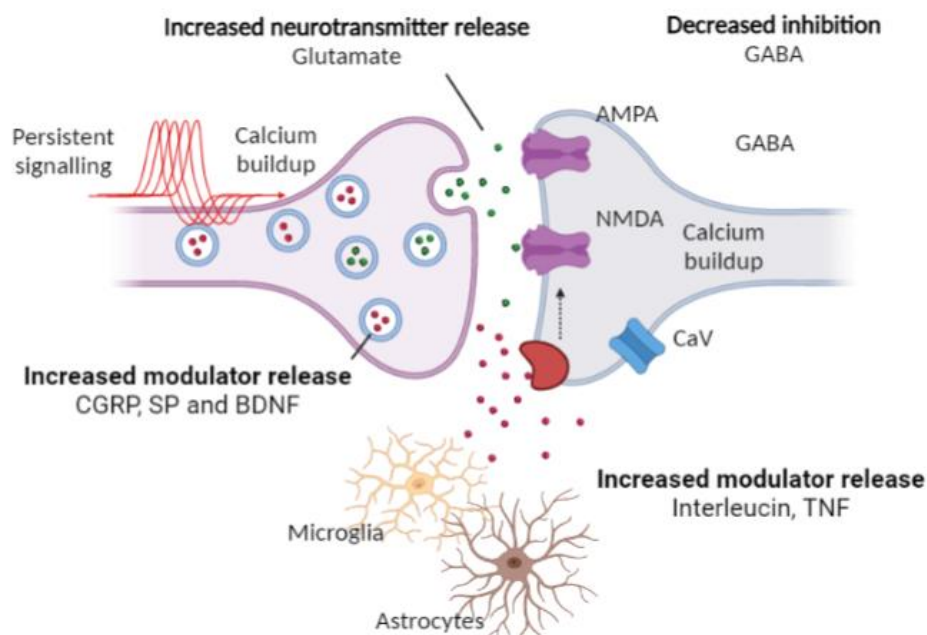

Figure 9 Central sensitization Long term potentiation mechanisms are shared with other types of synapsis, these include increased excitability and synaptic efficacy and loss of inhibitory activity from interneurons and afferents from non-nociceptive somatosensory neurons this phenomenon is called. **Drawings self-made with Biorender™.**

In summary, peripheral and central sensitization lead to a generally more active nociceptive system, from these alterations stem the chronification of pain and two interesting pain conditions.

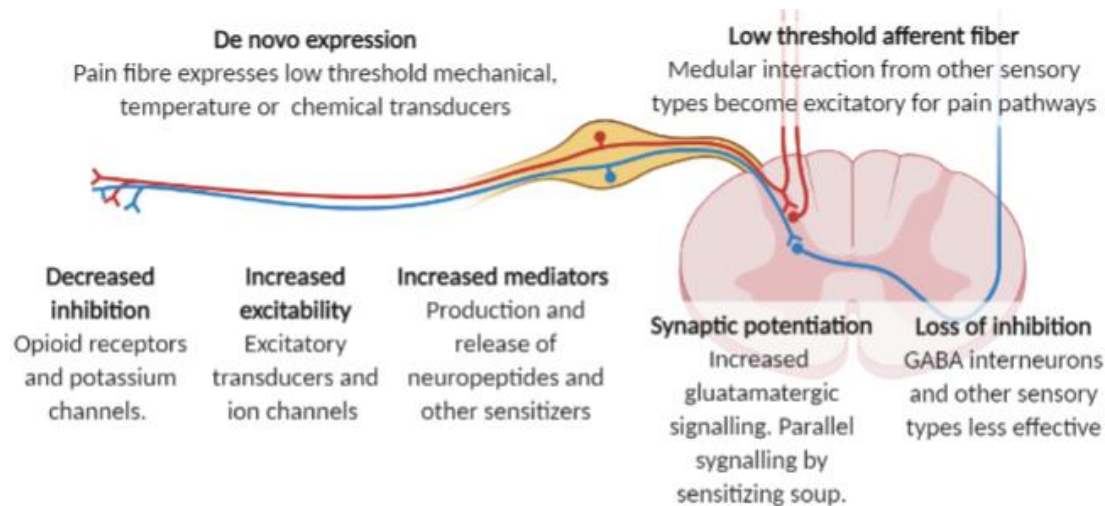
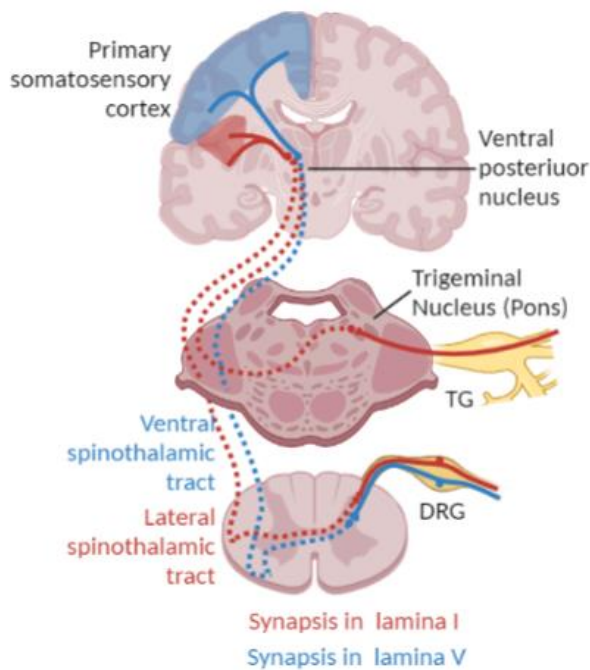

Figure 10 Summary of nociceptor sensitization. Peripheral and central alterations of the nociceptor include an increase in sensitivity and excitability of the system to noxious stimuli giving rise to hyperalgesia, where a painful stimulus produces an extreme response. While the de-novo expression of low threshold transducers in nociceptors and connectivity alterations in the spinal cord give rise to sensory crossing, where non noxious stimuli activate pain pathways producing allodynia. Both are symptoms of an altered nociceptive system. In general, these changes can persist in time, producing a chronic sensitized state. **Drawings made with Biorender™ tool.**

6. ASCENDING PATHWAYS

Primary afferent nociceptors establish synapses in the lamina I, II and V of the dorsal horn in the spinal cord according to the type of noxious stimulus (**Figure 5**). Once the noxious information reaches the spinal cord, it gets transmitted to different parts of the central nervous system, where sensory information is processed and evaluated giving rise to the pain perception. Nociceptive information reaches high level processing areas in the brain through the anterolateral system, which is composed by different ascending pathways: the spinothalamic, spinoreticular, spinomesencephalic, and sinohypothalamic tracts. Noxious information is mainly transmitted through the **spinothalamic tract** (**Figure 11**) to the thalamus and cerebral cortex. Depending on the lamina where the axons are originated and the type of noxious stimuli transmitted, the spinothalamic tract can be separated in two groups: secondary nociceptors from **lamina I** extend their axons to the other side of the spinal cord, ascending to the

thalamus through the lateral spinothalamic tract located in the lateral funiculus; axons from lamina I terminate in the ventral posterior nucleus of the thalamus, which then project to the insula in a topographic order. Axons from neurons in the **lamina V** also cross to the contralateral side of the spinal cord, and ascend through the ventral spinothalamic tract. This tract also establishes synapsis with the ventral posterior nucleus of the thalamus, projecting in this case to the 3rd area in the postcranial gyrus. Neurons from innervating the head arrive from the



trigeminal nucleus through the trigeminothalamic tract same thalamic nucleus. Thus, spinothalamic pathways allow for the **sensory-discriminative aspects of pain** (quality, intensity and location). Corresponding with the A δ nociceptors, which establish synapsis with lamina I and V and codify for the first well localizable pain.

Figure 11 Principal discriminative pain pathways. A δ fibres are myelinated nociceptors with medium size of their axons, thus their information arrives first into the spinal cord. There, they establish synapses with second order neurons in laminae I and V, these second order neurons decussate to the contralateral side of the spinal cord, and form the spinothalamic tract. Nociceptive information from the head arrives to the trigeminal nucleus in the dorsal pons and decussate to ascend along with the spinothalamic tract into the ventral posterior nucleus of the thalamus. From here information radiates to the primary sensory cortex in the 3rd parietal gyrus and the insula. *Drawings self-made with Biorender™.*

The spinothalamic tract conveys signals that mediate the sensory discriminative aspects of pain. The affective and motivational aspects pain is mediated by complex pathways that reach integrative centres in the limbic forebrain. These

alternative routes are the spinomesencephalic, spinoreticular and spinohypothalamic tracts. **Spinoreticular** tract ascends anterolaterally reaching the reticular formation and the thalamus, involvement of the reticular formation allows for the autonomic responses to pain stimulation. The **Spinohypothalamic** conveys information from laminae I and V and to the hypothalamus, participating in autonomic control, neuroendocrine and cardiovascular sympathetic responses that accompany pain syndromes. The **spinomesencephalic** tract contains axons from laminae I and V and reaches the reticular formation and the periaqueductal gray matter, it is thought to contribute to the affective component of pain. This tract also projects to the parabrachial nucleus, and from here, information radiates to the amygdala, which is related to the emotional responses as it is a key nucleus of the limbic system. Interestingly, it establishes connections with the PAG, which participates in the descending modulation of pain.

Noxious and thermal information from the head originates from first-order neurons located mainly in the trigeminal ganglia. Crossing the pons, trigeminal fibres descend to the medulla, forming the spinal trigeminal tract which terminates in the spinal trigeminal nucleus. Axons from the second order neurons cross the midline and connect with diverse targets in the brainstem and thalamus. Like their counterparts in the dorsal horn of the spinal cord, these targets can be grouped into those that mediate the discriminative aspects of pain and those that mediate the affective–motivational aspects.

7. SEXUAL DIMORPHISM OF PAIN PERCEPTION

Pain research has traditionally been carried out in males⁶⁸. This bias has led to sex-related inequities^{69–73}, leading to insufficient analgesic treatments for women^{74,68}. Indeed, women suffer more of chronic inflammatory pain^{73,75}, neuropathic alterations^{76–79} and other chronic sensitization-related painful conditions^{80–82}. As a consequence, evolution to chronic pain is twice more likely

in females than in males^{8,83,84}. Sex differences in pain sensitivity may result from neural and immune pathways differently regulated by sexual hormones^{85,86}. Much effort has been devoted to study the role of female sexual hormones like oestrogens with diverging results, being anti or proalgesic depending on the concentration and location. For instance, prolactin levels have been reported to increase during postoperative pain in females and promote cold hyperalgesia⁸⁷, but present a protective role in inflammatory and migraine pain⁸⁸. Another example is that allopregnanolone and progesterone have been found to reduce pain in some neuropathic models, while it has proalgesic effect in inflammatory ones⁸⁹. On the other hand, the male hormone testosterone has received less attention⁹⁰, although it has shown analgesic effect in preclinical^{91,92} and clinical studies⁹³. High levels of testosterone protect against menstrual pains⁹⁴, and females that receive testosterone replacement therapy for sex reassignment to male report lessened pain alterations while taking testosterone⁹⁵.

According to the localization of the pathophysiological mechanism, different sexually dimorphic processes have been described in pain processing. In the **periphery**, sexual hormones regulate nociceptor sensitivity and excitability by controlling expression and sensitization of transducers⁹⁶ in the peripheral and central terminals and along the fibres. Following nuclear signalling, estradiol receptor produces upregulation of TRPA1, TRPV1 and P2X receptors⁹⁷, producing increased sensitivity. Interestingly, estradiol also presents fast signalling over these channels⁹⁸, decreasing their typical desensitization upon activation. Previous literature had found that estradiol blocks the binding site for capsaicin in TRPV1, giving the impression that it had a positive effect against pain, but these experiments were performed with supra-physiological concentrations of the hormone (10nm)⁹⁹, marking the importance to assess this matter attending to physiological parameters. Oxytocin has shown agonistic effect over TRPV1, medium concentrations could produce activation of the channel, but high

concentrations lead to desensitization¹⁰⁰. The receptor TRPM3 can be activated by pregnenalone sulphate and modulated by estradiol and progesterone¹⁰¹. These hormone receptor is coexpressed with CGRP in peptidergic nociceptors, contributing to pain sensation¹⁰².

Central sensitization also presents differences, at the **spinal cord** level, the inflammatory response elicited by neuropathic pain has been reported to be different in males and females. While microglia seems to have a more relevant role in males, T lymphocytes present a more important role in females, probably through differences in toll like receptor 4 (TLR4) expression and function^{79,86,103–106}. Specifically microglial inhibition via TRL4 antagonism plays an important role in the male response to morphine, however this mechanism has not been confirmed for females^{107,108}. Testosterone has been reported to decrease neurogenic sensitization (in fibromyalgia patients) due to interference with substance P release. Long term potentiation in high-order central pain pathways has shown differences attending to sex in, including dendrite length and arborisation in the thalamus¹⁰⁹. Finally, there are also connectivity differences in the encephalon regulated by hormonal signalling, for example to cope with pain males increase the activity of threat control circuits in the amygdala (specially basal and lateral portions)¹¹⁰ and in females by emotion-processing areas like cingulate and insula^{111–113}.

The differential recruitment of motivational and emotional circuits in males and females could explain sexual dimorphism presented by the periaqueductal gray, where the central **opioid system** is originated¹¹⁴. Indeed, periaqueductal gray recruitment^{115,116,117} and descending pathways^{118,119,119,120} are more potent in males than in females, and its activity is clearly dependent on sexual hormones^{109,119,121–129}. In addition, women show smaller pain alleviation after treatments with canonical MOR agonists like morphine^{120,130–135}, this has been

associated to a lower expression of opioid receptors^{119,136} and reduced spinal secretion¹⁰⁸ of endogenous opioids in females. The stronger role of central periaqueductal gray in males is testosterone dependent¹³⁷, which not only regulates expression of mediators and receptors⁹⁰, but also has rapidly increases MOR sensitivity⁹⁰. In contrast, in females it could be that KOR play a more important role, mediated by oestrogen signalling^{138,139}. Indeed, sexual hormones regulate opioid receptor subtype expression (mu-/kappa-) in the brainstem^{140,141}, spinal cord^{160,161-163}, trigeminal nucleus¹⁴⁵, and trigeminal ganglia¹⁴⁶.

2. TRP CHANNELS IN SOMATOSENSORY PERCEPTION

1. GENERAL TRAITS OF TRP CHANNELS

The first TRP channel was described in *Drosophila Melanogaster*, it was discovered during phototransduction studies where mutant flies presented transient membrane potential changes in response to light stimulation¹⁴⁷. Study of TRP channels in sensory transduction and pain has granted the Nobel Prize in Physiology or Medicine 2021 to David Julius and Ardem Patapoutian. They were pioneers in the study of TRP channels in somatosensation and pain, the first findings regarded the role of TRPV1 in pain and temperature sensations¹⁴⁸. Further studies have depicted TRPV1 as an extremely complex protein that can be activated by heat, inflammatory substances arachidonic acid, acid pH, capsaicinoid compounds, voltage and many other stimuli like endocannabinoids¹⁴⁹. TRPV1 is one of the large family of TRP membrane proteins. At the moment there are 28 TRP channels described in mammals, which are organized by sequence homology into 6 subfamilies (**Figure 12**): canonic (TRPC), vanilloid (TRPV), ankyrin (TRPA1), melastatin (TRPM) and mucolopin (TRPML)^{150,151}. Homology studies situate TRP channels between voltage gated potassium channels and two-pore and sodium voltage-gated ion channels²⁸. The **TRP family** is composed by a diverse group of proteins with divergent sensory capabilities that are necessary for sensing environmental and endogenous stimuli.

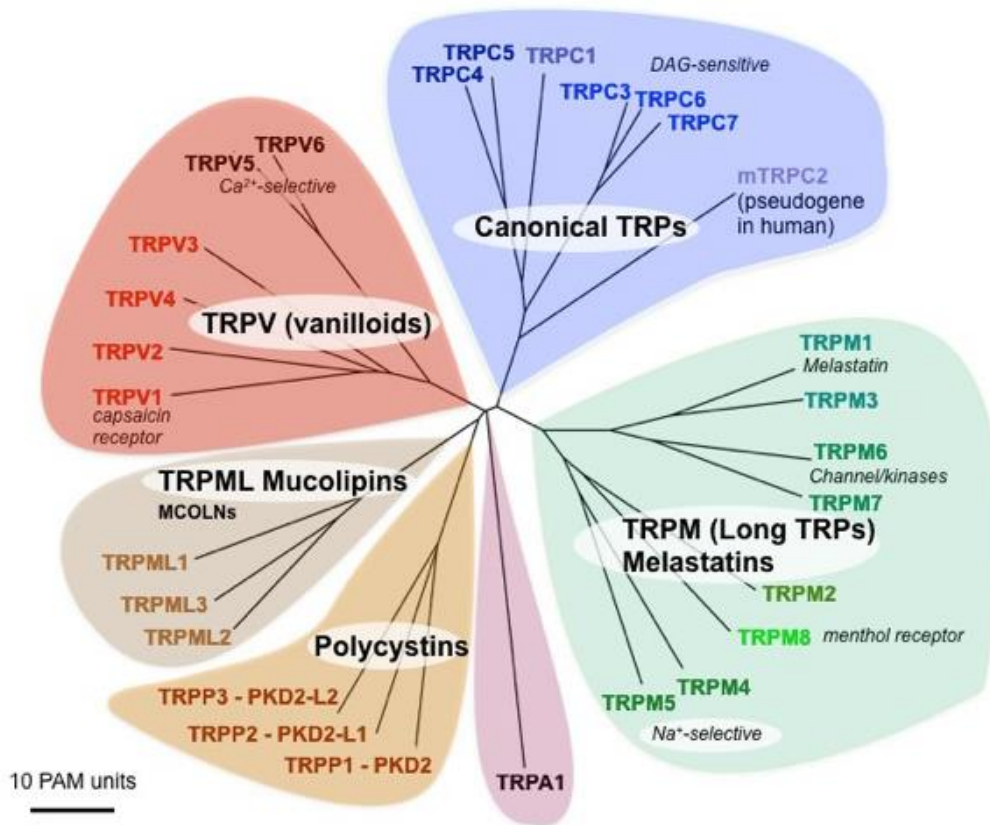

Figure 12 TRP family is composed by a diverse group of proteins with divergent sensory capabilities that are necessary for sensing environmental and endogenous stimuli.

The transmembrane domain is the most conserved region across the TRP family and presents high sequence similarity with voltage and ligand-gated potassium channels²⁸. Because of this, it is expected that all TRP channels form tetramers as functional units, as it has been confirmed through biophysical approaches¹⁵². Each subunit presents six transmembrane domains, the domains from the 1st to the 4th confer voltage sensitivity, while the 5th and 6th form the ion pore (**Figure 13A**). The extracellular loop between the 5th and 6th transmembrane domains forms the selectivity filter, whose stereochemical and electrostatic properties dictate that only cations can cross ($\text{Ca}^{2+} > \text{Mg}^{2+} > \text{Na}^+ \text{K}^+ \text{Cs}^+$)¹⁵³ (**Figure 13A**). N and C-terminal extensions are cytosolic and contain the regulatory components that control the channel gating, thus the function of each TRP is strongly dependent on the specialization presented in these terminals (**Figure 13B**). Intracellular domains are highly diverse and are the base for the differentiation

between TRP subfamilies²⁸. These regions have specific functions such as protein-protein interaction, formation of homomeric and heteromeric complexes, temperature, voltage and mechanical transduction, interaction with second messengers like calcium and inositol triphosphate, interaction with enzymes like kinases and phosphatases and finally regulation of the gating of the ion channel¹⁵⁴ (**Figure 13B**).

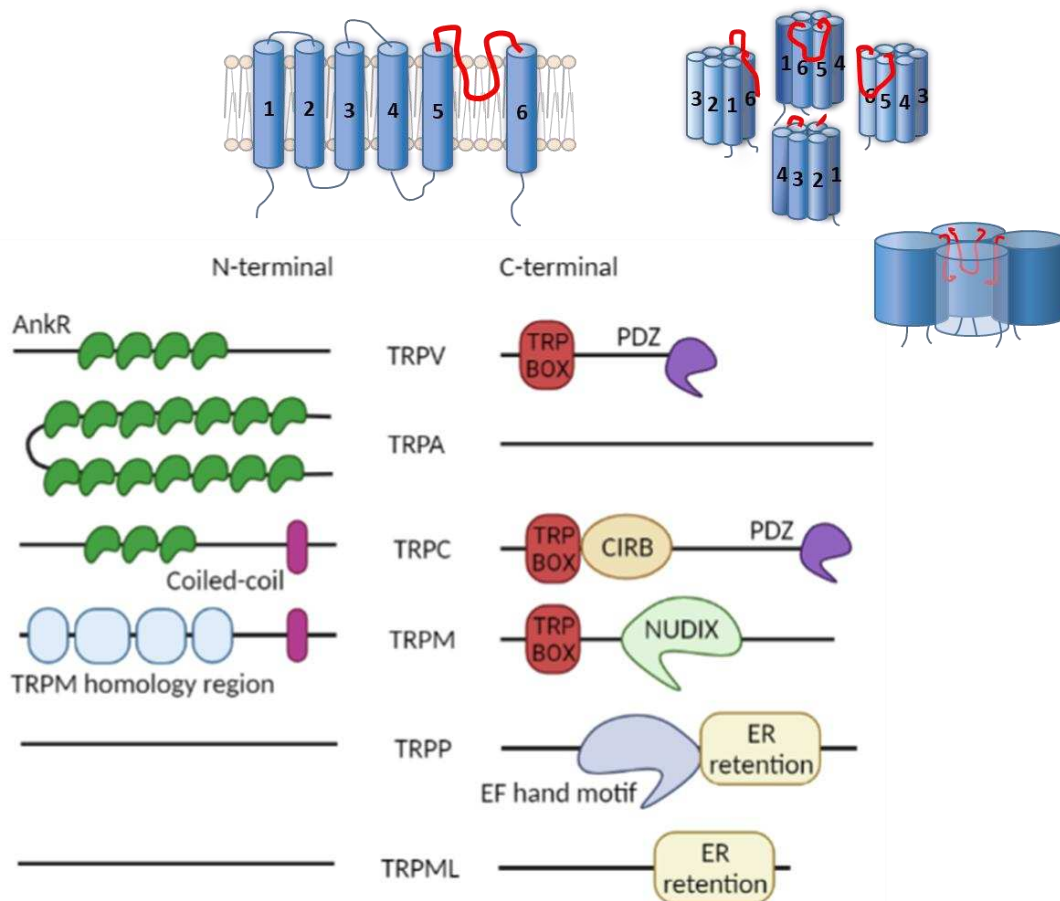

Figure 13 TRP structure-function. A) TRP subunits. Each TRP subunit is formed by 6 transmembrane domains, with cytosolic N- and C-terminals. TRP subunits form tetramers with the transmembrane regions 5 and 6 orientated to the inside and forming the ion channel, extracellular loop in red forms the selectivity pore. **B) C- and N-terminals are highly divergent between TRP subfamilies, and determine their function.** Ankyrin repeats form a scaffold for protein-protein interaction, with expected functions of assembly and trafficking and coordination with signalling modules like calmodulin, acyl coenzyme A, phospholipase C, synaptotagmin and snapin. The TRPA channels present many repetitions forming a long spring which has been suggested to

allow for mechanical and thermal transduction. **TRP BOX** is necessary for both channel tetramer formation and coupling of sensor regions and channel gating, they hold the channel in a closed conformation, it can be targeted by phosphatidyl inositol bisphosphate and other molecules to destabilize its structure and increase open probability of the pore. **PDZ domain** can interact with phospholipase C, protein kinase C, calmodulin and inositol triphosphate, coordinating the activity of enzymes and second messengers. **Coiled-coil** regions are responsible for the oligomerization of proteins in a highly specific manner. **TRPM homology regions** are important for channel transport to the membrane and oligomerization. **EF hand** motifs in TRPP can function as calcium sensors. **ER retention domain** in TRPP and TRPML controls subcellular location of the channel. **NUDIX** motif presents hydrolase activity. Finally, **CIRB** plays a role in protein-protein interaction and also binding sites for calmodulin and inositol triphosphate. *Drawings self-made with Biorender™.*

Regarding their localization, TRPs can be found in almost all cellular types and tissues, in plasma and intracellular membranes^{149,151}. Their polymodal activity and vast distribution allow these channels to participate in diverse physiological functions, i.e.; phagocytosis, cell migration, proliferation and death¹⁵¹. In particular, TRPs are relevant in many sensory modalities^{149,155}, especially in pain for their role in nociception and sensitization^{149,156,157}. TRP receptors are known for their thermosensitivity, there are receptors activated by mechanical forces and endogenous and exogenous compounds (**Table 2**).

As molecular transducers, some TRPs (i.e.; TRPV1/2/4, TRPA1, TRPM3) can be activated by noxious stimuli (i.e.; extreme temperatures, inflammatory factors or pungent compounds), with the consequent opening of the ion pore depolarizing calcium and sodium currents. In addition, it has been described that some TRP like TRPV1, TRPA1 and TRPM3 are expressed in C peptidergic nociceptors, and their activation leads to calcium-dependent release of vesicles containing neuroinflammatory peptides (CGRP and SP) that produce sensitization.

TABLE 2 SENSITIVITY OF RELEVANT TRP CHANNELS IN PAIN TRANSDUCTION

	A1	V1	V2	V4	M2	M3	M4	M5	M8
Mechanical	X			X					
Heat (°C)	>42	>41	>52	>28	X	20-32	X	X	
Cold (°C)	<17								<27
Ca ²⁺	X			X			X	X	
Acidosis	X	X							
REDOX	X		X		X				
Nitric oxide	X	X							
Cannabinoids	X		X	X					
Acrolein	X	X							X
LPS	X	X							
Hormones		X				X			X

TRP channels also present a strong matrix of second messenger regulation, which participate in the modulation of their activity **Figure 14**.

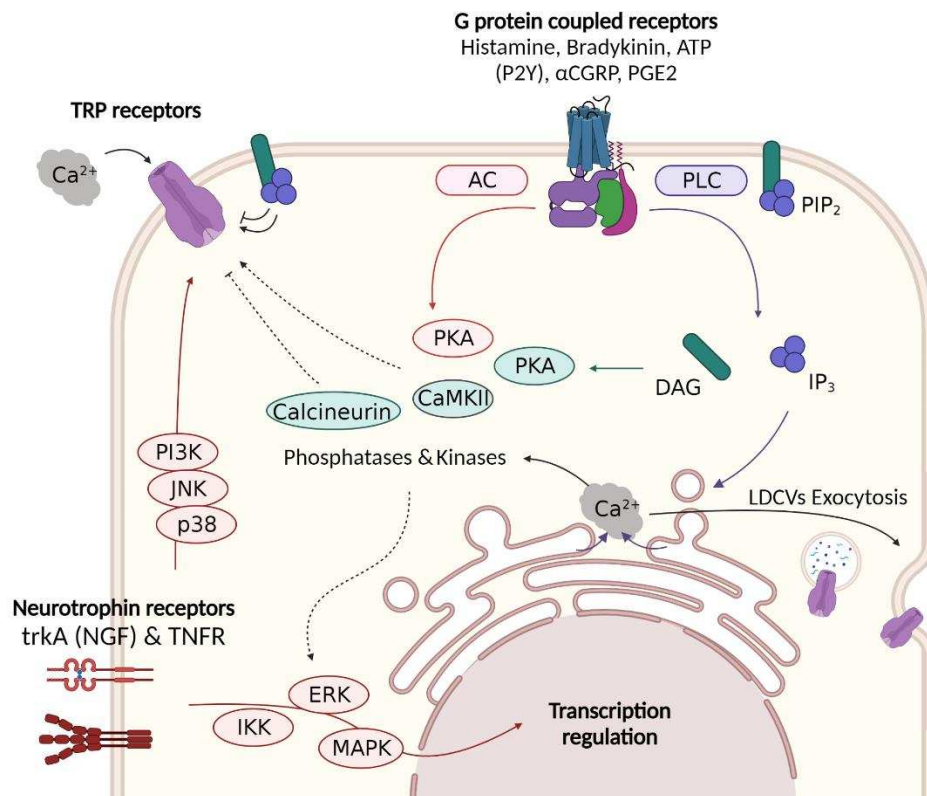

Figure 14: General regulatory cascades regulating TRP activity. Drawings self-made with Biorender™.

For these reasons, TRP channels have been considered as potential therapeutic targets. TRPV1 antagonists have been tried for pain treatment, but they showed undesired secondary effects for its role in thermoregulation. High doses of TRPV1 agonist capsaicin (which desensitize the channel by intense activation) are being used for pain associated with neuralgia, rheumatoid arthritis and muscle sprains^{14,25,158,159}. TRPA1 antagonists and antioxidants (which reduce TRPA1 activation by ROS and NO₂) have proven useful against neuropathies^{14,25,158,159}. There are also preclinical studies with promising results on targeting TRPV3, TRPV4, TRPM2 and TRPM3 and TRPM8^{158,160}. Migraine is a sensitization-dependent pain alteration, that requires the release of CGRP to evolve into a persistent condition. Blocking CGRP signalling is proving effective treatment against migraine, with botulinum toxin that inhibits its liberation, with anti-CGRP antibodies and with CGRP receptor blockers. Thus, TRP implication in pain perception, sensitization processes and neuroinflammation makes them pharmacologically interesting, especially in migraine^{161–165}.

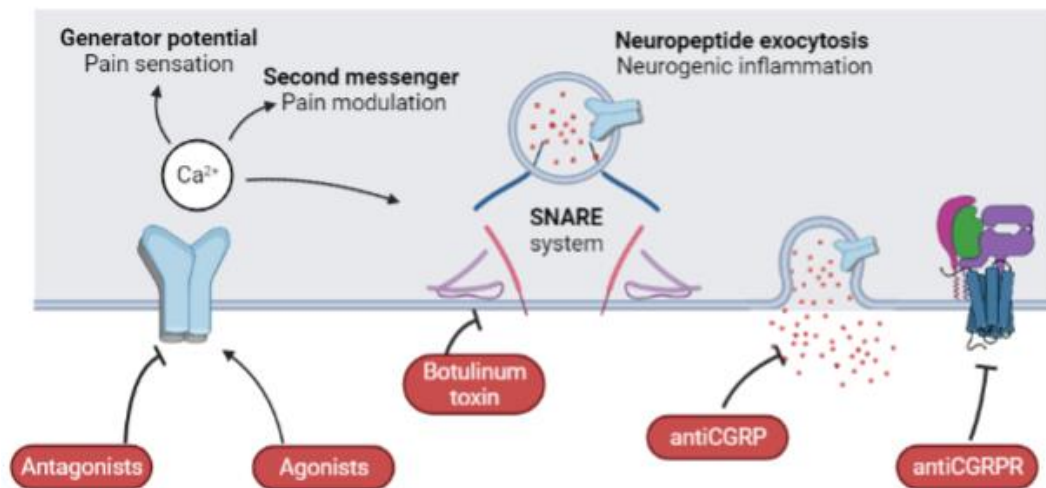

Figure 15 TRPs signalling and sensitization as druggable targets for migraine Antagonism of TRPs or their sensitization pathways could block nociceptive transduction and CGRP release, agonists with potent desensitization effect could achieve the same result. Inhibitors of neuropeptide exocytosis like botulinum toxin have been proven useful for the treatment of migraine, in this work we also tried the novel DD04107, a peptide that also inhibits the snare complex. Finally, antibodies against CGRP or its receptor are showing good results for migraine treatment. *Drawings self-made with Biorender™.*

2. TRPA1

TRPA1 is a multipurpose transducer that is activated by a variety of chemical signals, and has also been implicated in cold and mechanical noxious sensation. It works as a sensor of danger signals that can threaten the health of the organism, including stress, tissue damage and other noxious cues, like UV light, environmental irritants and toxic products¹⁶⁶. TRPA1 activation in the nociceptors produces pain like sensations, but It also produces CGRP release, coordinating the inflammation to provide homeostatic response against the incoming insult. However, excessive activation of TRPA1 might conduce to algescic sensitization and chronification of pain and inflammatory conditions. TRPA1 is the only one of its subfamily described. As the other ones, receptors are formed by four TRPA1 subunits and thus are usually homomers, although heteromomers with TRPV1 have been suggested^{167,168}. Each subunit is formed by six transmembrane α -helices, with intracellular C and N terminals. The pore region is formed by an extracellular loop between transmembrane segments 5 and 6. As in other The N- and C-terminus of TRPA1 determine much of its function and regulation. Here we present a brief rationale of the structure-function of the channel. The N-terminus presents a series of ankyrin repeats (from 14 to 18 depending on the species), which hold seven described phosphorylation targets and a calcium binding domain. The ankyrin domain has also been associated to protein-protein and subunit interaction. Finally, this motif is also suspected to participate in thermal and mechano sensation, although this is still in debate¹⁶⁶. In fact, there is a theory for TRPA1 thermosensitivity that attributes this activity to aminoacids distributed along the protein¹⁶⁹, later in-vitro study described that TRPA1 is indeed activated by high and low temperatures. Continuing through the N-terminus we can find a number of cysteine and lysine residues that can be targeted by electrophilic and oxidizing compounds (**Figure 16**), which activate the channel through covalent bonding. In the transmembrane α -helices there are also some targets for electrophilic compounds, but more importantly in the transmembrane region 5

there is the binding pocket for non-electrophilic agonists, like carvacol. In the extracellular loop between the 5th and 6th transmembrane α -helices a number of glutamic and aspartic acid residues form the selectivity filter of the pore, while leucine 903 confers voltage sensitivity to this structure. Voltage gating structures can also be found in the 6th transmembrane α -helice and along the C terminal. The first portion of the C-terminus forms a second selectivity filter in the intracellular side of the ion pore. This same region contains several calcium sensitive motifs, which are targets for calmodulin. C-terminus also presents a coiled coil motif that plays a role in allosteric gating of the channel¹⁵³.

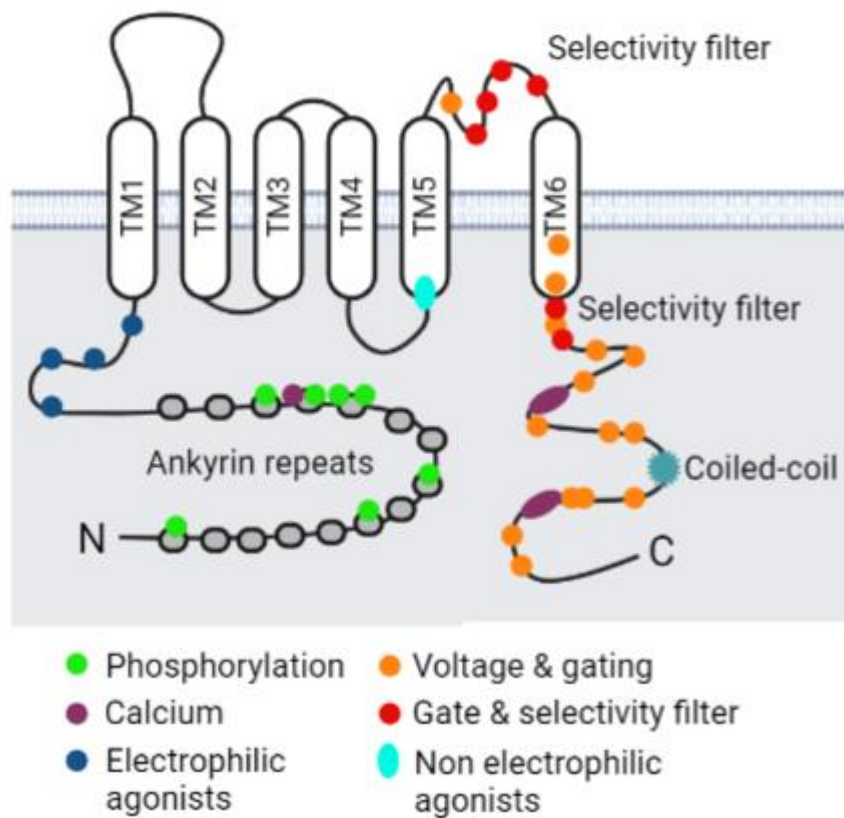

Figure 16 TRPA1 structure-function (copied from chen & hackos, 2015). Many electrophilic agonists of TRPA1 can activate the channel by covalent unions with Cysteine 665, 641 and 621 and with lysine 710 n humans and with C415, C422 147 and C622. (AITC, allacin, cinnamaldehyde, acrolein and croton aldehyde H2O2, isoflurane, lidocaine, propofol, formalin, nitric oxide, oxidized lipids, zinc, Hydrogen peroxide and methyl glyoxal. Non electrophilic agonists react with transmembrane region 5 amino acids L867, V875, L894, 175 P897, S900, I905, V942, S943, I946, some of these agonists are protons, thymol, carvacol, menthol, nicotine,

tetrahydrocannabinol, clotrimazole and nifedipine. Temperature activation of TRPA1 has been associated with the spring-like ankyrin repeats and with some residues distributed across the protein. Intracellular calcium potentiates the channel by binding to the calcium binding pockets in the N and C terminals and in the pore and indirect c terminal calmodulin binding domain. The ankyrin repeats have a tether that grants mechanical connection, subunit interaction¹⁶⁶.

TRPA1 was originally found in human foetal lung fibroblasts⁴⁷, further investigations have found expression in the heart, brain, digestive system, lungs, joints, skeletal muscles and bladder⁴⁷. TRPA1 is also present in sensory neurons like the inner ear where it works as a mechanosensor and it is prominently expressed in satellite and Schwann glial cells, where its activation produces release of sensitizing factors NO₂, cytokines and BDNF (**Figure 17**) TRPA1 is expressed in a subpopulation of dorsal root and trigeminal ganglia nociceptors and it is strongly coexpressed with TRPV1 and CGRP. Activation of TRPA1 produces a depolarization of the nociceptors and a local increase in calcium concentration¹⁶⁶ which triggers large dense core vesicle fusion with the plasma membrane and CGRP release. Calcium binding regions modulate the activity in two ways, incoming calcium potentiates the receptor and then desensitizes it, decreasing its activity in the long term or after saturated activation of the channel¹⁷⁰. TRPA1 activity can be upregulated by GPCR activation and other calcium releasing mechanisms, GPCR (like PAR2, bradykinin receptor, and mRGPR) also phospholipase C and protein kinase A and C¹⁷¹. Finally, reactive species of oxygen and nitrogen species can modulate the activity of the TRPA1, directly gating the channel or via indirect signalling through NADPH and peroxidated lipids like 4hydroxy2nonenal¹⁷².

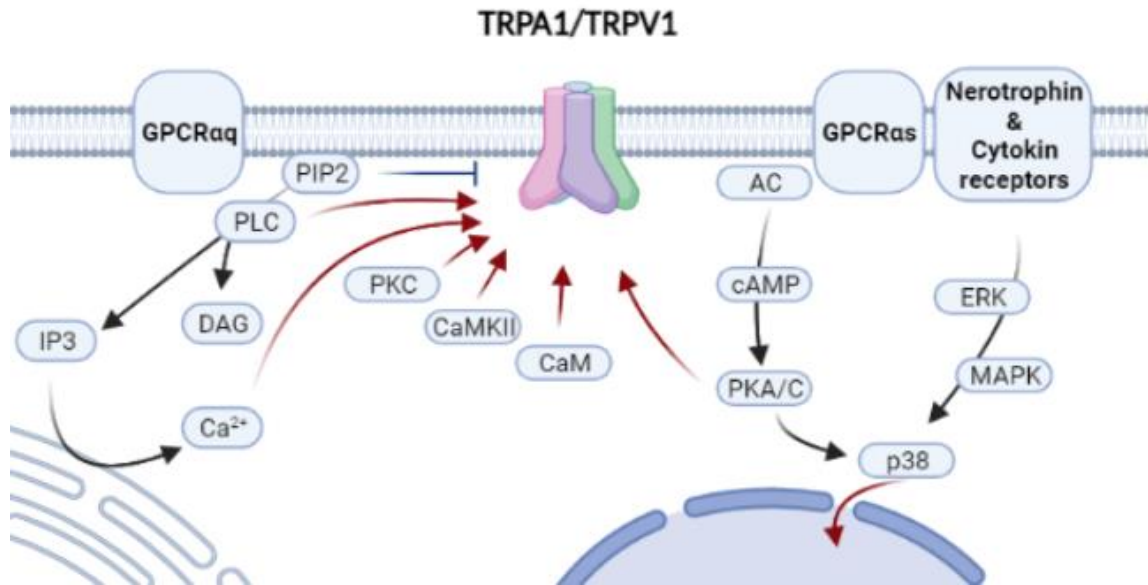

Figure 17 Sensitization and signalling pathways of TRPA1. Sensitization can involve both direct and indirect pathways. TRPV1 and A1 have been extensively studied in relation to nociceptive sensitization, thus we use it as a canonical example that could be applied to many other ion channels and receptors. There are multiple points of interaction between second messenger pathways that are engaged after nociceptor activation, including at the levels of signalling molecules such as Ca^{2+} , effector molecules such as $\text{PKC}\epsilon$, and common targets, such as TRPV1 and NaV1.8 (not shown) for the pathways activated. CaM, calmodulin; PLC, phospholipase C. DAG, diacylglycerol; IP3, inositol triphosphate; AC, adenylate cyclase; EPAC, cAMP-activated guanine exchange factor; ERK, extracellular signal-regulated kinases. **Drawings self-made with Biorender™.**

Animal pain models showed that TRPA1 has a clear role in acute^{173,174} inflammatory and neuropathic pain^{44,167,175}. The role of TRPA1 as a thermosensor and a mechanosensor is a matter of debate^{157,176}. Originally, TRPA1 was suspected to be a cold receptor¹⁷⁷, but these results are still debated, nevertheless it seems to participate in cold hypersensitivity sensitization processes. Interestingly, TRPA1 has been associated to noxious heat sensation¹⁷⁸, a recent breakthrough¹⁰² has shown that TRPA1 collaborates with TRPM3 and TRPV1 to produce the response to noxious high temperatures.

3. TRPM8

TRPM8 receptor forms a voltage-gated cation channel, it is formed by four homomers and each subunit has 6 transmembrane alpha-helices, 5th and 6th transmembrane domains of each subunit, and the selectivity filter is formed by the extracellular loop between them. The melastatin receptor also presents a long intracellular N and C terminus. TRPM8 is sensitive to a variety of molecules from aromatic pants, like romerol, thimol, canfor, icilin and menthol, the binding pocket for icilin is formed by residues in the third transmembrane alpha-helice and the extracellular loop between helices 5th and 6th. Menthol binding site is formed by residues from the second and 4th transmembrane alpha-helices. The C-terminus is particularly relevant in the modulation of this channel, near the membrane in the C terminus TRPM8 presents a TRPbox with potential binding sites for PIP2, which activates the receptor. This structure is followed by a TRP domain with function is to regulate the gating of the channel and it also participates in the binding of menthol and PIP2. Menthol has been used as a classical agonist to study the activity of TRPM8, although but it has proven to also activate TRPA1¹⁷⁹, for this reason the use of WS-12 can be useful, it binds to the same pocket as menthol and presents stronger potency a major specificity¹⁸⁰. Finally, C-terminus presents a coiled-coil structure that serves as a tetramerization domain.

Regarding TRPM8 modulation, we can see some differences with TRPA1; PKA/C activation produces inhibition of the channel and downregulation of its expression¹⁸¹, the same effect is produced by the activation of adenylate cyclase. If we look at the regulation by GPCRs, bradykinin and histamine receptors that produce TRPV1 and TRPA1 potentiation produce TRPM8 inhibition¹⁸¹. Furthermore, activation of kinase pathways unchains calmodulin-dependent serine/threonine protein phosphatase calcineurin, which produces TRPM8 desensitization by dephosphorylation¹⁸¹. In the somatosensory system, TRPM8 is mainly expressed in C and A δ fibres, it is estimated that around 10% of trigeminal

and drg neurons express TRPM8, and it is lowly coexpressed with TRPV1 and TRPA1¹⁸². Activation of TRPM8 in sensory neurons produces depolarization of and increase of intracellular calcium concentration, repetitive activations of TRPM8 produce a desensitization of the channel due to calcium binding the C terminus¹⁵².

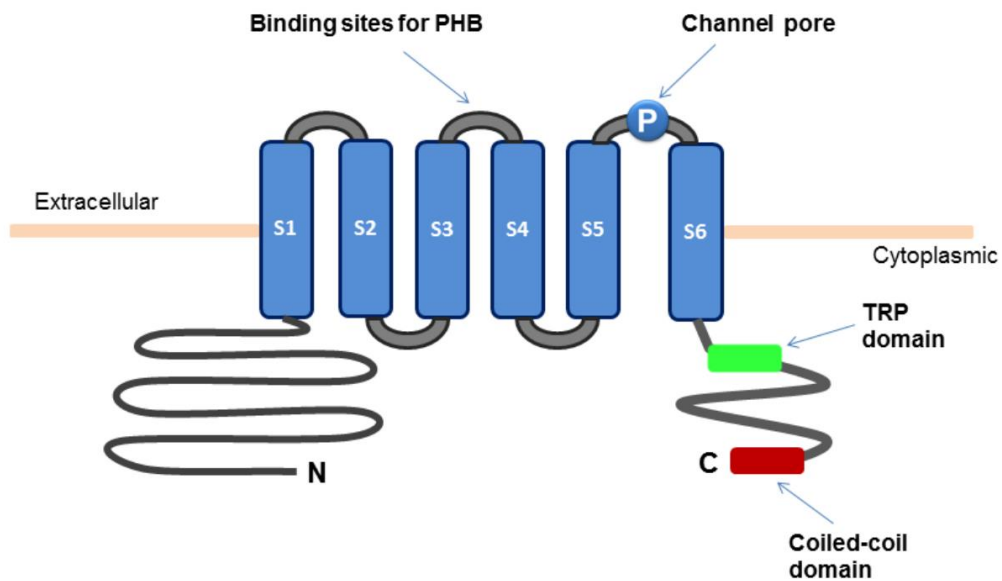

Figure 18 TRPM8 function. Cold sensitivity of TRPM8 is tightly regulated by the pore region, binding site of menthol and other traditional agonists and of lipids like PIP2 is near the voltage sensor in the TRP domain. This region is also important for the desensitization upon activation characteristic of this receptor.

In vivo function, TRPM8 has been appointed as the main cold sensor and its typical exogenous agonists like menthol, icilin and eucalyptol conduce to a pleasant cooling sensation^{155,183-185}. Although its expression in internal organs of the body kept at constant temperature suggests potential additional roles of this receptor apart from temperature perception^{165,186}. As an example of internal monitoring, TRPM8 has been suggested to be a testosterone receptor^{187,188}, where TRPM8 can regulate sexual behaviour through testosterone signalling. TRPM8 relation with pain is highly controversial. In humans, a TRPM8 variant associated with lower TRPM8 expression is also accompanied by lower cold

hypersensitivity¹⁸⁹. Furthermore, it has been related with hypersensitivity to cold in neuropathies derived from chemotherapy in animal models¹⁸². In contrast to these results, TRPM8 activation by moderate cooling and topical or intrathecal icilin¹⁹⁰ produced rapid analgesia in mice with nerve injury, it was also effective in mechanical and thermal preclinical pain studies¹⁹¹. Then, activation of TRPM8 in basal conditions is not associated to pain sensation, and its activation in sensitised states could lead to cold hypersensitivity, but also analgesia in other types of pain.

3. MIGRAINE

Migraine is a chronic paroxysmal neurological disorder, characterized by headache that ranges from moderate to severe, it is accompanied by a plethora of associated symptoms, including sensory and autonomic manifestations. Migraine profoundly affects the life of patients by altering their ability to develop a proper social, familiar and work behaviour, and has an economic annual cost that exceeds 20 billion US\$¹⁹². Migraine pain is usually a unilateral throbbing sensation that is aggravated by physical activity and head movement¹⁹³, and it can affect any part of the head, cervical and trapezius areas. Pain peak is usually reached within one hour of its onset, and its duration can range from 4 to 72 hours¹⁹⁴ (Table 3). Additional characteristic symptoms of migraine include sensory hypersensitivity such as cutaneous allodynia, photophobia, phonophobia and autonomous alterations such as nausea and emesis¹⁹⁵. Also, patients might present other symptoms like vertigo, dizziness, and cognitive impairment¹⁹³. It is frequent for migraine pain attacks to be preceded by a premonitory (prodrome) state lasting hours or days¹⁹⁶ (**Table 3**), which includes a myriad of alterations, such as fatigue, impairment in concentration, neck stiffness, aura and many others¹⁹⁷. Episodic migraine is described as a paroxysmal disorder with discrete pain attacks separated by symptom-free intervals. Around 8% of migraineurs develop chronic migraine, which is defined by a higher frequency of pain attacks with persistent symptoms^{198,199}. The effects of chronic migraine in the quality of life of the patients are deleterious, since the intensity and frequency of the attacks impedes almost any normal activity on its sufferers.

Table 3 Migraine phases:

Prodomre	Aura	Headache	Postdrome
3h to several days	5-60 minutes	4-72 hours	1-2 days
Concentration deficit, irritability, depression	Seeing bright flashing dots, blind spots and vision loss	Head pain	Concentration impairment
Difficulty speaking and reading	Numb or tingling skin	Sensitivity to light, noise and odors	Depression
Trouble sleeping, yawning	Speech changes	Nausea, vomiting, abdominal pain, diarrhea	Fatigue
Nausea or Food cravings	Tinnitus	Loos of appetite	Euphoria
Fatigue	Alterations in smell and taste	Altered temperature perception and fever	
Sensitivity to light and sound		Pallor	
Increased urination		Dizziness and blurred vision	
Muscle stiffness		Tender scalp	

4. EPIDEMIOLOGY

Lancet Global Burden of Disease 2019 (world health organisation data) ranks migraine as the third most prevalent condition²⁰⁰ and the seventh highest specific cause of disability worldwide²⁰¹. Yearly, migraine affects up to a 12% of global population, and the distribution of the affected population presents a strong sexual bias. The lifetime and annual and prevalence are 13 and 6% for men, respectively, and 33% and 18% in women. The onset of migraine generally occurs in the early twenties, the prevalence is highest in the midst of the adulthood, and it starts to decay after midlife, around the 55 years. Despite being pre-eminently an adult illness, it can affect up to a 10% of the children between 5 and 18 years-old. Interestingly, at young ages (less than 13) the rate of onset is higher in boys than in girls. Every year, up to a 3% of episodic migraines evolve into a chronic

condition²⁰²⁻²⁰⁴ and as a consequence, 8% of the migraine-suffering population end with this life-burdening condition.

5. PATHOGENESIS OF MIGRAINE

Migraine pathogenesis is an issue of intense debate, there are supporters for a peripheral and a central origin of migraine. **Central origin of migraine** is suggested by the **prodrome phase**, which characterized by certain patterns of central nervous system activations (cortical spread depression (CSD), activation of the hypothalamus and brainstem) before the onset of pain⁶⁷. **Cortical spread depression** affects from 15 to 20% of migraineurs during the prodrome, it is an intense and generalized depolarisation of cortical glia and neurons that slowly (2mm/min) sweeps the cortex, producing increase of extracellular concentrations of potassium, indiscriminate glutamate release and alterations in cranial blood flow. It is considered the main reason for the sensory alterations present in the patients that suffer from **aura** during the premonitory phase. Excitatory (extracellular accumulation of potassium and glutamate) and inflammatory conditions (vasodilation) would produce activation of trigeminal nociceptors¹⁹³. It has also been discovered in mice that CSD can activate second order neurons in the trigeminal nucleus, through top down regulation of somatotopic efferents from the cortex¹⁹³. During prodrome there is also activation of the **hypothalamus**, this is believed to be the connection between homeostasis alterations (i.e.; food and sleep deprivation) and migraine. Hypothalamic activation produces release of vasoactive polypeptides⁶⁷, which also explains some of the manifestations of the prodrome, i.e.; yawning, polyuria and food cravings. Premonitory phase also presents an activation of the **brainstem**⁶⁷, particularly the noradrenergic **locus coeruleus** and serotonergic **dorsal raphe nucleus**, which project into the thalamus and can decrease the threshold for transmission of trigeminovascular signals to the cortex¹⁹³.

Peripheral origin of migraine has been less studied⁶⁷, supporters of the **peripheral origin of migraine** argue that the migraine **headache** is ultimately produced by **trigeminal activation**¹⁹³. Another important point is that not even half of the patients suffering from migraine present a clear **prodromal phase** prior to the head pain⁶⁷. Then, the principal origin for migraine would be an excessively excitable trigeminal somatosensory system, that initiates nociceptive signalling in response to low intensity stimuli. In fact, patients with higher frequency attacks present stronger responses when challenged with different types of sensory stimuli¹⁹³, including somatosensory, nociceptive and olfactory stimuli. Interestingly, migraineurs showed decreased habituation and stronger sensitization in response to repetitive stimuli⁶⁷. Interestingly, blocking CGRP release in a migraine model prevented the development of cortical spread depression. In addition, antioxidants and blockers of nitric oxide production also prevented CSD in a murine migraine model²⁰⁵. These results suggest that central activation could follow CGRP/Nitric oxide released by the trigeminovascular system. Finally, classical migraine treatments like triptans are not able to cross the blood brain barrier (as they are strongly hydrophilic), as they were designed to target peripheral serotonin receptors in blood vessels and peripheral sensory terminals⁶⁷. Furthermore, new migraine treatments like anti-CGRP monoclonal antibodies⁶⁷, are also impermeable to the blood brain barrier, but still are showing successful CSD^{206,52} prevention and alleviation of migraine pain²⁰⁷, again marking the importance of the periphery for the migraine initiation^{208,209}.

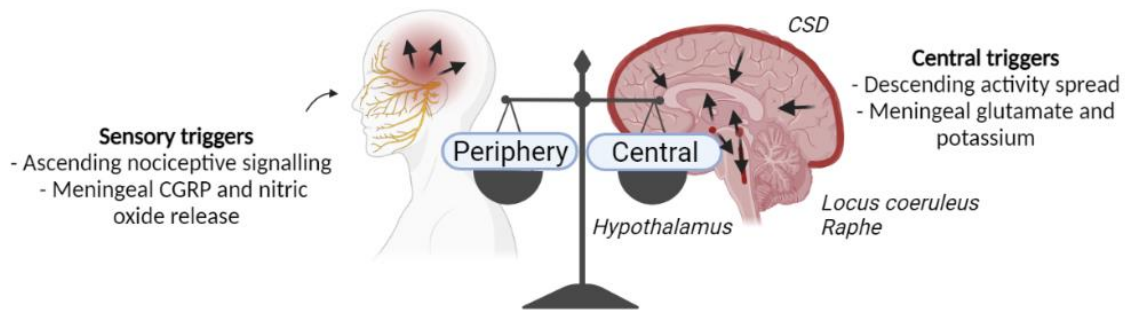

Figure 19 What comes first? It could be possible that both theories are compatible, and migraine patients have a more excitable peripheral and central nervous system. Therefore, migraine treatments could be directed against nociceptive transduction and ascending transmission of the pain signals.

6. PATHOPHYSIOLOGY OF MIGRAINE

Migraine head ache is described as a drilling and throbbing sensation that typically starts on one side of the head and then spreads to the other regions. It is clear that **migraine pain** starts with an over-activation of the trigeminovascular system that innervates the meninges and eyes¹⁹³. The innervation of these regions is provided by the ophthalmic division of trigeminal nerve and the upper cervical spinal roots (DRGs)²⁰. Activation of the trigeminal nociceptors produces release of CGRP, glutamate and nitric oxide in the periphery (i.e. meninges), the trigeminal ganglia and in the central terminal at the trigeminal nucleus. These substances produce the already explained pain sensitization and neurogenic inflammation cascades⁶⁷ (**Figure 21**). Activation of nociceptors in the trigeminal initiates a pain signal that propagates centrally through the trigeminal somatosensory pathways. Trigeminal fibres converge and synapse on projecting neurons in the trigeminal nucleus, the convergence explains why migraine pain extends and refers to the occipital and nuchal regions⁶⁷. Trigeminal second order neurons ascend to the brainstem, hypothalamus, basal ganglia, thalamus and cortical regions that process nociceptive information. Once in the cortex, the parietal sensory cortical area provides sensory-discriminative information, while insula and cingulate participate in the emotional response, finally retrosplenial and parietal association

cortical regions codify cognitive value of the nociceptive input. Trigeminal signalling during migraine produces a barrage of nociceptive activity that can spread into other circuits. For example, in the midbrain it can affect compartments of the autonomic system producing nausea, lacrimation and transpiration, also in the midbrain when it affects the vestibular system it can produce vertigo, dizziness and tinnitus. Its effects on the hypothalamus might facilitate anxiety, stress and irritability and produce food cravings. Spreading activity to the basal ganglia explain the arousal deficits, including cognitive impairment or brain-fogg associated to migraine. Migraine nociceptive activity can also spread to other association cortical areas, including auditory, visual and olfactory. The spread of trigeminal activity could underlie the sensory hypersensitivity that accompanies migraine, including mechanical allodynia, photophobia, phonophobia and osmophobia.

7. TRIGEMINAL SENSITIZATION IN MIGRAINE

Migraine attacks produce **peripheral sensitization (Figure 21)** of the trigeminal somatosensory system (explained previously in the section "Nociceptor sensitisation"). In migraine CGRP and nitric oxide are pivotal for the sensitization, as blocking CGRP and ROS/nitric oxide signalling prevents migraine development in preclinical models²⁰⁵, and CGRP treatments are being used with success²¹⁰. Continuous sensitization leads to an increase in TRP, ASICs, CGRP and NOS expression in animal models and in humans²¹¹, increasing the sensitivity of nociceptor terminals to noxious stimuli and becoming more potent neuroinflammators. Among the different TRPs, TRPA1 has been pointed as a relevant transducers in migraine for its role in CGRP release in the trigeminovascular system in response to nitric oxide and other relevant migraine mediators²¹²⁻²¹⁵²¹⁵. Furthermore, TRPA1 is also expressed in different cells types that participate in the meningeal sensitization characteristic of the migraine, including glia and endothelial cells²¹⁶. TRPM8 has also been correlated with

migraine in humans²¹⁷⁻²¹⁹. At least 4 different single nucleotide polymorphisms of the TRPM8 channel have been linked to migraine prevalence¹⁸⁹. Interestingly, agonists of the melastatin receptor such as eucalyptol and menthol have traditionally been used for migraine alleviation and for other types of inflammatory pain^{220,221}, and of the head, neck and face have proven useful in preventing and alleviating migraine pain²²². Sensitized trigeminal nociceptors are activated by stimuli of less intensity and can be triggered by endogenous factors such as sexual hormones, oxidative stress and acidic medium^{223,224} as well as by exogenous signals like strong sounds, temperature changes or pungent compounds like the smoke of a cigar^{212,225,226}.

Sensitization derived only from nociceptor activation seems to be important in the trigeminal ganglia, where excessive activation of nociceptors conduces to local secretion of molecules in what has been recently called **intraganglionic sensitization (Figure 20)**^{61,227}. Incoming action potentials arriving mainly from the periphery, but also from the central terminal produce CGRP and ATP release from the cell body of peptidergic C nociceptors. CGRP binds to its receptor (G-coupled protein receptor plus auxiliary Ramp1), and produces second messenger signalling, in other A δ nociceptors it induces BDNF production and transport to the central terminal, while also increases expression of ATP ion channel receptors P2X. CGRP receptor is also present in satellite glial cells, its activation produces upregulation of nitric oxide synthase (NOS) and nitric oxide secretion, it also upregulates brain derived neurotrophic factor and cytokine production which are released into the ganglion. Nitric oxide signalling has retro-alimentation properties, as it induces neuronal NOS production and more nitric oxide release to the medium, which in peptidergic nociceptors elicits CGRP release and overexpression. Finally, BDNF and cytokines secreted by satellite cells produce upregulation of CGRP and ATP receptors in nociceptors, as well as changes in sodium and potassium voltage gated channels.

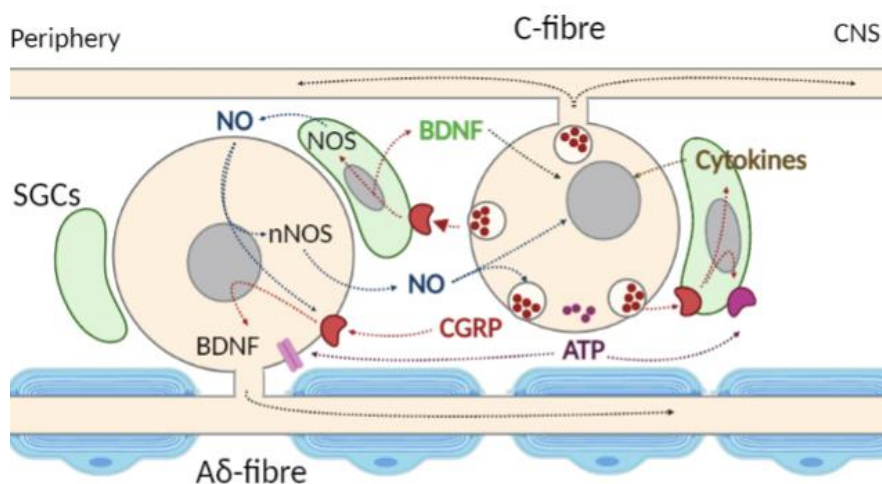

Figure 20 Intraganglionic sensitization. Activation of C-fibres produces increase of intracellular calcium, which promotes large dense core vesicles containing CGRP to fuse with the cellular membrane and release the neuropeptide. CGRP signals over other nociceptors (A δ or C) and to satellite glial cells (SGCs) expressing CGRP receptors. CGRP receptors may activate intracellular cascades involving cAMP response-element binding protein (CREB) or mitogen-activated protein kinase (MAPK) to induce gene expression of purinergic (P2X3) receptor channels in neurons and purinergic (P2Y) receptors in SGCs, enzymes like nitric oxide synthase (NOS), cytokines like tumour necrosis factor (TNF α) as well as growth factors like brain-derived neurotrophic factor (BDNF). Nitric oxide (NO), cytokines and BDNF may signal back to neurons facilitating expression of purinergic receptor channels, CGRP and CGRP receptor. In addition, ATP released from neurons may activate SGCs, which can signal back to neurons by cytokines. CGRP, CGRP receptor and BDNF can influence transduction and synaptic transmission, because they are delivered by axonal to the peripheral and central terminals. *Drawings made with Biorender™.*

Migraine also produces **central sensitization** with increased signal transmission to the second order neurons in the trigeminal nucleus, this explains associated secondary effect like hypersensitivity scalp sensitivity and tenderness in the pericranial muscles suffered by migraineurs between migraine attacks²²⁸. Sensitization in the thalamic relay (third order neurons), is associated to a spread of noxious sanitation to extracephalic structures like skin sensitivity in limbs and aching muscles⁸⁸. Finally, repeated attacks can also decrease the efficacy of opioid descending pain modulation, increasing the excitability of the pain pathways²²⁹. The accompanying symptoms of trigeminal sensitization are indicators of the

advancement of the illness into a chronic migraine. It is believed that repeated attacks make cumulative changes that lead to a hyperactive system with decreased threshold for migraine triggering. For example, intrathecal CGRP of chronic patients is increased even between migraine attacks, also migraine patients that develop mechanical hypersensitivity are more prone to evolve into chronic patients.

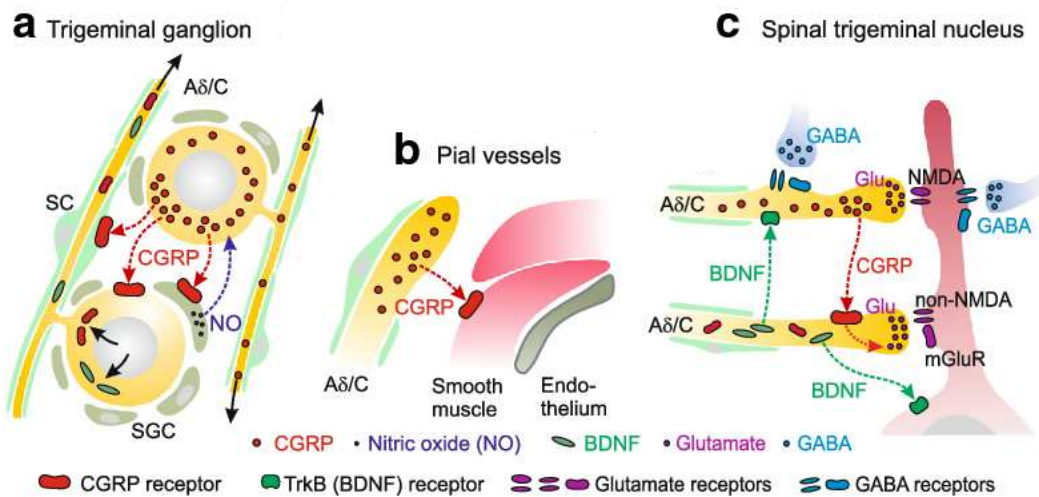

Figure 21 Sensitization in the trigeminovascular system. In the trigeminal ganglion **a**) CGRP released from neurons may signal to neighbouring neurons, glial satellite cells (GSC) and possibly Schwann cells (SC) expressing CGRP receptors and can produce nitric oxide (NO), brain-derived neurotrophic factor (BDNF) and CGRP receptor. Nitric oxide may signal back to the neurons and BDNF and CGRP may be transported through the central extensions of trigeminal nociceptors to the spinal trigeminal nucleus. **b**) CGRP signalling the pial vessels in the meninges causes vasodilatation. **c**) Within the spinal trigeminal nucleus CGRP is released from central terminals of trigeminal afferents and signals most likely to other central terminals equipped with CGRP receptors, which may lead to increased neurotransmitter (glutamate) release and facilitation of nociceptive transmission. Release of BDNF may pre- and postsynaptically potentiate synaptic transmission. Neurons with inhibitory neurotransmitters (GABA) may counteract the pronociceptive synaptic processes.

Despite the evident relevance of CGRP in migraine, there are patients that do not respond to the interference of CGRP signalling. A recent study in a murine model of migraine has pointed to pituitary adenylate cyclase-activating peptide (PACAP-

38) as a new migraine eliciting pathway, which would work through partial inhibition of ATP-sensitive potassium channels²³⁰.

8. MAIN MIGRAINE TREATMENTS

Given the relevance of CGRP in preclinical and clinical investigations, recent developments of substances against CGRP signalling are showing promising results. Here we include all the treatments for migraine that are FDA approved (**Table 4**), which already include antibodies that bind to the CGRP peptide or its receptor. In addition, onabotulinum A (Botox) has been repurposed for the treatment of chronic migraine²¹⁰. Apart from these, there are many more candidates of CGRP interfering molecules in clinical trials. Beyond targeting CGRP, there is also interest in the nitric oxide production and signalling and transducers that participate in its release like TRP receptors²³¹.

Table 4 Main migraine treatments²¹⁰

classification	Agents	Mechanism	Contraindication
Migraine abortive	Triptans & ergotamines	Agonist of 5HT 1D/1B	Coronary artery disease
	Naproxen	COX1/2 inhibitor	GI disorders
	Rimegepant/ubrogepant	CGRPR antagonist	Hypersensitivity to compound or excipients
Migraine prophylaxis	Erenumab	CGRPR antagonist	None
	Galcanezumab/Fremanezumab/epitezumab	Binds to CGRP	Hypersensitivity to compound or excipients

9. MIGRAINE SEXUAL DIMORPHISM

Migraine presents a strong sexual dimorphism and its prevalence is higher during the reproductive years in life, when sexual hormones are in higher levels⁶⁷. Women suffer from more intense migraines and higher percentage of evolution into a chronic alteration²³². As it happens in other pain conditions, female hormones present positive and negative effects in migraine. Cycling oestrogens

in the menstrual cycle are related to an increase of frequency and intensity of migraine attacks²³³ and this alteration can be corrected with continuous oestrogen supplementation or hormonal depletion²³⁴. Furthermore, high levels of oestrogens during the pregnancy are associated to a decrease in migraine prevalence²³⁴. It has been suggested that estradiol increases CGRP production and release from nociceptors, and also increases nitric oxide synthase in the endothelium, presenting a more potent neurogenic inflammation²³⁵. In contrast to this, high concentrations of oxytocin^{84,195} and estradiol²³⁶ modulate the activity of serotonergic system, decreasing CGRP liberation and migraine. Oestrogens also increase nociceptor excitability in the trigeminal ganglia²³⁷, because of upregulation of Nav1.7 channels, and curiously progesterone decreases their activity²³⁸. Regarding androgens, it has been described that men with chronic migraine present lower levels of testosterone when compared with normal population²³⁹. And testosterone replacement therapy reduces headache attacks²⁴⁰

10. MODELS FOR THE STUDY OF MIGRAINE

Migraine models produced in mice are obtained by different methods, each one presents certain advantages and disadvantages. **Producing the model**²⁴¹. Migraine models can be obtained by direct electrical stimulation of trigeminal nerve or ganglia; this allows for precise activation of nervous structures. Its use-cases are limited due to its invasiveness. Another model of migraine is obtained by application of inflammatory substances on the meninges, including (histamine, serotonin, bradykinin, prostaglandin, capsaicin, low pH cytokines and complete Freund's adjuvant), it is also possible to use CGRP and nitroglycerin. Refinement of the method allows for less invasive procedures and repetitive application of stimuli through cannulation of the cranium. Finally, substances can be applied systemically (IP) with the advantage of very low invasiveness that makes it optimal for chronic treatments, as a disadvantage it produces systemic sensitization.

Techniques to study the migraine model²⁴¹. In vivo measurements include electrophysiological recordings of trigeminal ganglia and nucleus, with this technique we can study directly the activity of nociceptive circuits in response to the model. But, it only allows for acute measurements in immobilised animals. Effects of migraine model can be assessed by behavioural experiments, like mechanical allodynia with von frey filaments, cold allodynia with acetone drops and heat allodynia with infrared stimulation. Other less common behavioural experiments include spontaneous pain behaviours and photophobia. Study of nervous structures by immunohistochemistry and PCR allows to study changes in expression and localization of relevant targets in migraine. *In-vitro* preparations like trigeminal cultures and brain slices allow to study functionality of the implicated structures. These approaches allow to study in detail cellular processes, but loose representatives of the systems complexity. In relation to this, study of cultured neurons can be refined by the use of microfluidic chambers, that allow to study different compartments of the neurons separately.

We decided to use a model of migraine²⁴² that has demonstrated strong translatability and allows for chronic administration of the substances with low impact in the stress of the animal, as well as make repetitive measurements. We used the sensory sensitization produced by intraperitoneal injection of the nitric oxide donor nitroglycerin²⁴³. Acute intraperitoneal injection of nitroglycerin produces mechanical hypersensitivity that can be elicited by cutaneous stimulation. This sensitivity appears with 1-2 hours of delay and lasts for hours in laboratory animals and humans^{205,243} and is a good predictor of migraine chronification²⁴⁴. Furthermore, recurrent nitroglycerin injections produce a chronic hypersensitivity that persists for weeks in mouse and rat models^{242,245}. The resulting chronic hypersensitivity is accompanied by systemic cutaneous sensitization, that is known to predict evolution to chronic migraine in humans²⁴⁴.

OBJECTIVES

*I don't know why they
Always seem so dismal
Thunderstorms, cloud, snow
And a slight drizzle
Whether it's the weather
Or the letters by my bed
Sometimes death seems better
Than the migraine in my head
-Twenty-one Pilots; Migraine*

OBJECTIVES

1. GENERAL OBJECTIVES

Physiological mechanisms underlying migraine are still being discovered, and as a consequence the reasons behind sexual dimorphism are obscure to this moment. This work is centred in the study of the sex factor in a murine model of chronic migraine, and thus validate it to study the potential role of TRP channels and neuropeptide CGRP in these differences between sexes. Migraine becomes especially crude when it evolves into a chronic condition, thus the focus was directed to the role of the TRP channels and CGRP in the pain sensitization and chronification.

2. SPECIFIC OBJECTIVES

1. **Characterization of the nitroglycerin-induced migraine model in both sexes.** *In-vivo* measurement of skin mechanical sensitivity by Von-Frey. Stress-related measurement of the adrenal gland size.
2. **Determination of the relevance of TRPA1, TRPV1 and TRPM8 in the migraine model.** Genetic and pharmacological study of the role of these channels *In-Vivo* by Von-Frey and *In-Vitro* by calcium imaging and RT-qPCR of the trigeminal ganglia.
3. **Study of the relevance of CGRP in the migraine model.** Relevance of CGRP in this model of chronic migraine. Genetic and pharmacological investigation of the importance of CGRP neuropeptide *In-vivo*. Study of the link between nitroglycerin administration, TRP activation and CGRP release *In-Vitro*.
4. **Assess the function of male hormone androgen in the sex differences presented in the migraine model.** Study of testosterone in the mechanical sensitivity in male and female mice in the migraine model. Study of the activity of testosterone on TRPM8.

Taken together, the final purpose is to unveil the link between TRP activity, CGRP liberation and the sexual differences presented by migraine, with the objective to describe potential new druggable targets to tackle migraine.

RESULTS

*It will not let me sleep
I guess I'll sleep when I'm dead
And sometimes death seems better
Than the migraine in my head
-Twenty-one Pilots; Migraine*

RESULTS

1. CHARACTERIZATION OF THE MIGRAINE MODEL

1. REPEATED NITROGLYCERIN TREATMENT INDUCES A PERSISTENT HYPERSENSITIVITY EXCLUSIVELY EXPRESSED IN FEMALE MICE

The first step of the project consisted on testing the chronic effects of repeated nitroglycerin administration. Mechanical sensitivity was assessed in male and female mice before and after repeated nitroglycerin administrations (**Figure 22**).

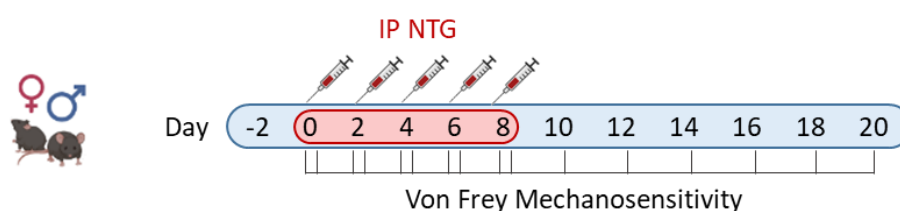

Figure 22 The nitroglycerin chronic migraine model. The experiment was performed on wild-type female and male mice. nitroglycerin was administered at experimental days 0, 2, 4, 6 & 8. On these days, von Frey was performed before and 2 hours after the injection to monitor the acute effect of the treatment. Then, mechanical threshold was only registered once a day at days 11, 13, 15, 17, 19 and 21 to assess long lasting effects in the animals.

In the first trial, animals were treated with nitroglycerin 10 mg/kg i.p. in a specific formulation containing final concentrations of 10% ethanol and 20% propylene glycol in 0.9% saline solution. Measurements of mechanical sensitivity two hours after nitroglycerin injection showed lower thresholds both for male and female mice ($p < 0.001$ vs. vehicle). Surprisingly, the vehicle was able to also increase mechanical sensitivity of females ($p < 0.05$ vs. baseline).

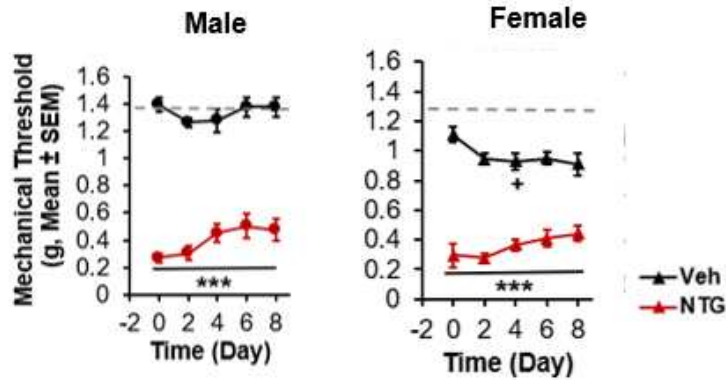

Figure 23 Nitroglycerin and a vehicle with high percentage of ethanol and propylene glycol induce acute mechanical sensitization. Nitroglycerin (red) 10 mg/kg dissolved in 10% ethanol and 20% propylene glycol induces similar acute mechanical hypersensitivity in males and females, and this vehicle (black) induces a selective acute sensitization in females.

Mechanical thresholds measured before the nitroglycerin injections and until day 20 showed that male and female mice developed a mechanical sensitization beyond the last nitroglycerin injection. Mechanical sensitivity in males recovered basal values around experimental day 16 ($p > 0.05$ vs. vehicle), while females stayed sensitized until the last day of study ($p < 0.001$ vs. vehicle). The vehicle was able to produce sensitization by itself, although it was more apparent in females ($p < 0.05$ vs. baseline at day 2, $p < 0.01$ vs. baseline at day 8). The effect of the vehicle in mechanical sensitivity made it not suitable to continue using this formulation of nitroglycerin, especially because it presented different effects attending to the sex of the animal, for this reason we looked for a different formulation.

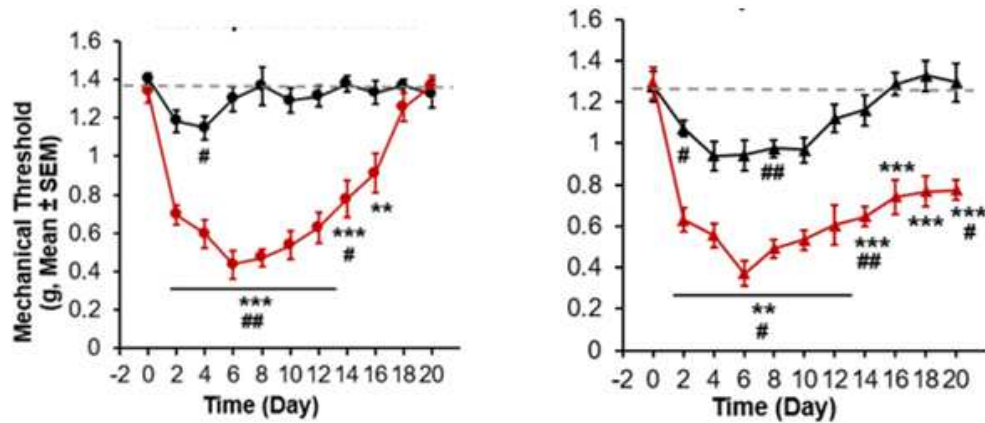

Figure 24 Chronic nitroglycerin induces persistent hypersensitivity exclusively in females, and a transient hypersensitivity is observed in males and females treated with this vehicle. Data are \pm S.E.M. ** $p < 0.01$, *** $p < 0.001$ vs vehicle. # $p < 0.05$, ## $p < 0.01$ vs baseline. 2-way RM ANOVA. $n = 6$ per condition. Ntrigeminal, nitroglycerin. Veh, Vehicle.

Thus, we tried a different formulation with a vehicle containing 5 % dextrose and 0.105% propylene glycol in 0.9 % saline solution. This vehicle showed no measurable effect in mechanical thresholds of male or female mice hence it was the composition used for all the subsequent experiments. Mechanical sensitivity measurements taken two hours after nitroglycerin administration showed development of hypersensitivity in both sexes (**Figure 25A**), meaning that lower force was needed to elicit paw withdrawal ($p < 0.001$ vs vehicle). After ending the repeated treatments, hypersensitivity in nitroglycerin-treated male mice persisted up to eight days after the last injection, but they recovered basal values at experimental day 18 ($p > 0.05$ vs. vehicle). Female mice remained sensitized until the end of the experimental procedure on day 20 ($p < 0.001$ vs vehicle) (**Figure 25B**). The results from this model presented a sexual dimorphism that was not described before in a model of chronic migraine: while males could fully recover from nitroglycerin, females persisted sensitized with no significant recovery from the initial mechanical hypersensitivity shown on day 20.

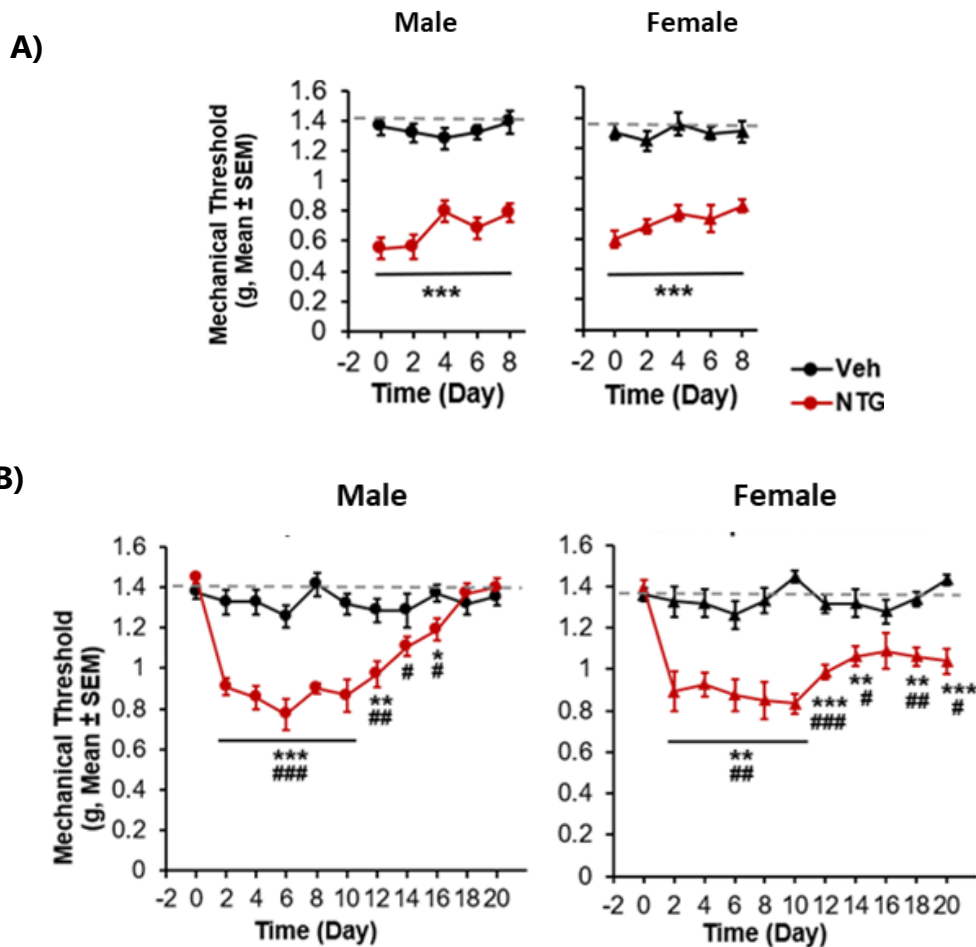

Figure 25 Nitroglycerin produced persistent hypersensitivity in females. A) Acute administration of nitroglycerin 10 mg/kg IP produced a decrease in mechanical thresholds two hours after administration in both sexes. C) Chronic nitroglycerin injection produced a long-lasting mechanical sensitization that was only persistent in female mice, whereas males recovered their normal sensitivity at experimental day 18. Male and female animals treated with the vehicle (5% dextrose and 0.105 propylene glycol) presented normal mechanical thresholds. Data are mean \pm S.E.M. A) $***p < 0.001$ vs vehicle. 2-way RM ANOVA; $n = 6$ per condition. B) $**p < 0.01$, $***p < 0.001$ vs vehicle. $\#p < 0.05$, $##p < 0.01$, $###p < 0.001$ vs baseline. 2-way RM ANOVA; $n = 6$ per condition. nitroglycerin, nitroglycerin. Veh, Vehicle.

2. THE OESTROUS CYCLE DOES NOT PRODUCE OVERT MODIFICATIONS IN NITROGLYCERIN-INDUCED MECHANICAL HYPERSENSITIVITY

Our migraine model obtained by repeated nitroglycerin administrations produced a chronic hypersensitivity that was specifically persistent in females. These differences could be produced by sexual hormone signalling, adding a level of complexity given that concentration of these hormones change in female mice

during the oestrous cycle. Thus, we investigated if the oestrus cycle could be affecting mechanical sensitivity after nitroglycerin or vehicle treatment. To assess this, we repeated the nitroglycerin model in wild-type females (**Figure 27A**). Then, 6 days after the end of the chronic treatment the mechanical sensitivity of the animals was assessed and the oestrus phase for each animal was determined by vaginal smear examination. Animals were separated in two groups: females with low estrogen levels (oestrus) and females with high estrogen levels (proestrus, metestrus and diestrus), as previously described¹³⁹ (**Figure 27B**). The analysis of mechanosensitivity in these animals yielded unexpected results, since we could not find differences between females with high and low oestrogens (**Figure 27C**).

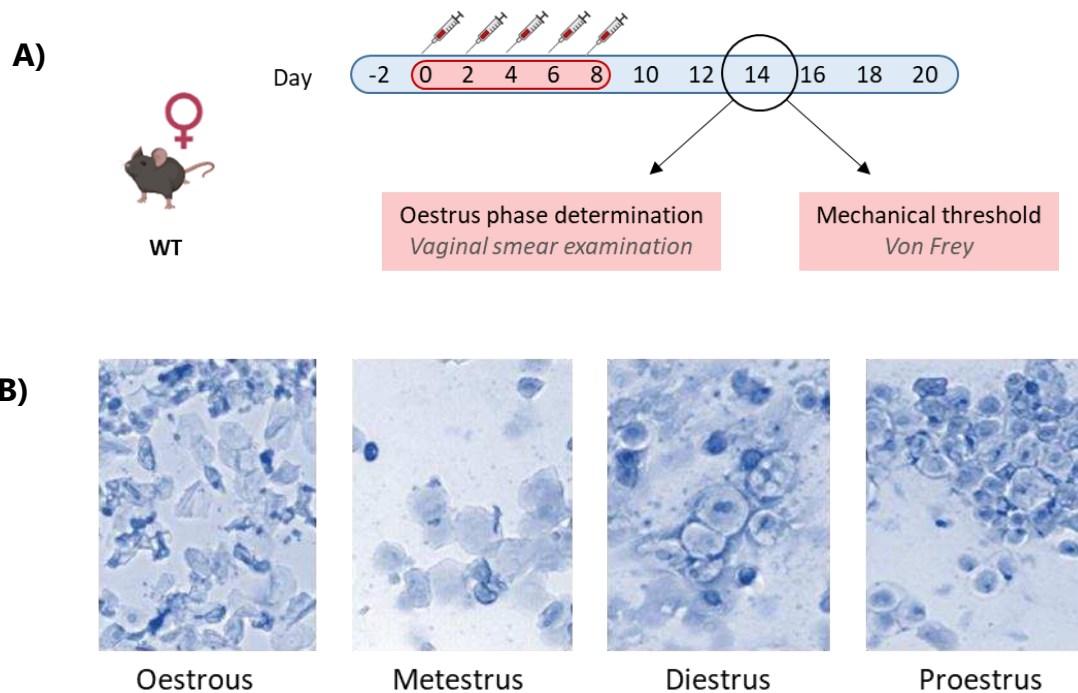

Figure 26 The oestrus cycle did not affect mechanical hypersensitivity. **A)** Female animals were subjected to the chronic nitroglycerin migraine model, and their mechanical sensitivity was assessed as described previously. After the last experiment on day 20, a vaginal smear was taken and stained with Crystal Violet **B)** The phase of the estrous cycle was estimated by visual characterization of the cellular types found in the vaginal smear. (*Continued in next page*)

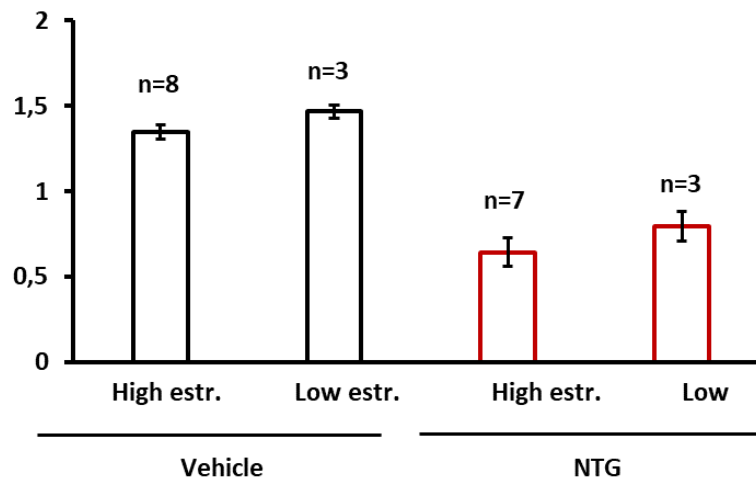

Figure 27 The oestrus cycle did not affect mechanical hypersensitivity. C) Mechanical thresholds measured by von frey data were separated between two groups decided by the vaginal smear (high and low estrogens). Data presented as mean \pm SEM, paired T test showed no differences between groups of the same treatment.

3. CHRONIC NITROGLYCERIN TREATMENT PRODUCED ADRENAL GLAND ENLARGEMENT MORE PROMINENT IN FEMALES

Stress indicators like adrenal gland size²⁶² and plasma cortisol levels²⁶³ rise in response to pain models, and can be used to assess pain suffering in murine models of pain²⁴⁶. The objective of this measurement was to ascertain the sexual dimorphism observed by von Frey in the chronic migraine model. We chose to measure the size of the adrenal gland as a reliable indicator of chronic stress response²⁴⁷ (**Figure 28A**). It is important to highlight the basal differences in the organ's size between sexes already at a resting state, where adrenal glands from females are much larger than male ones (**Figure 28C**), as it happens in humans²⁴⁶. Quantification of fresh adrenal gland weight at experimental day 20, showed a significant increase of the size of the adrenal glands in females treated with nitroglycerin, but in males the size of the organs did not change (**Figure 28B**).

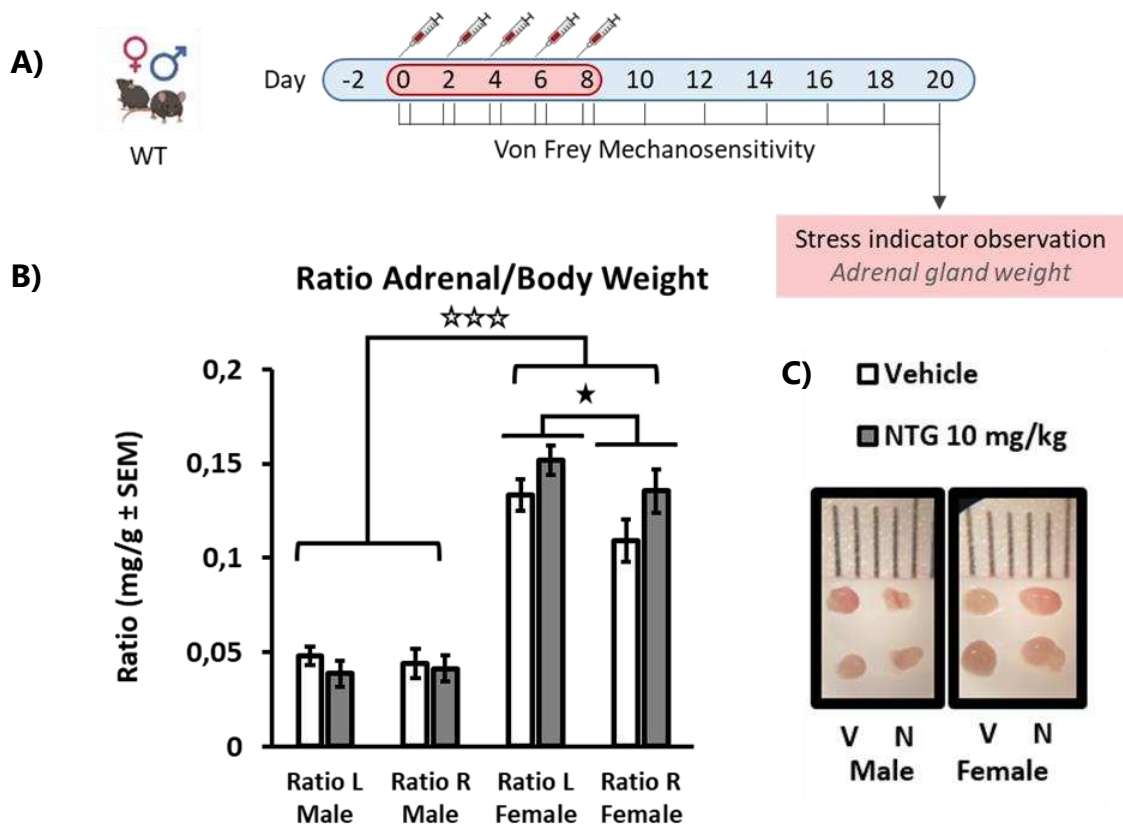

Figure 28 Chronic nitroglycerin treatment produced hypertrophy of females adrenal glands. **A) Protocol.** Male and female wild-type mice were subjected to the nitroglycerin migraine model, after the last measurement animals were sacrificed and their adrenal glands extracted and weighted. **B) Examples of adrenal glands.** These glands had already been peeled from interstitial tissue and fat, interesting to note that female adrenal glands have much bigger size than male ones. **C) Female adrenal gland weight increased after chronic nitroglycerin,** adrenal weight showed an increase in size only in female treated with nitroglycerin when compared with vehicle treated females, while males treated with nitroglycerin presented similar values when compared with vehicle males. Data are presented as mean \pm SEM, two-way ANOVA. * $p < 0.05$ vs treatment in females, *** $p < 0.005$ vs male.

In summary, nitroglycerin intraperitoneal injection produces mechanical hypersensitivity that can be measured by Von Frey filaments. Repeated injections produced long lasting hypersensitivity that was persistent only in female mice. Phase of the estrous cycle did not affect mechanical thresholds. Chronic nitroglycerin treatment produced visible enlargement of adrenal glands only in female mice.

2. ROLE OF TRPA1 IN CHRONIC MIGRAINE MODEL

1. TRPA1 IS ESSENTIAL FOR ACUTE AND CHRONIC NITROGLYCERIN SENSITIZATION

TRPA1 plays an important role in pain alterations, especially in sensitization processes that require oxidative stress¹⁶⁶. Furthermore, it has been pointed as an important trigger of headaches and migraine, and it has been directly implicated in acute nitroglycerin-induced mechanical hypersensitivity²⁰⁵. However, such participation has only been investigated in males and after acute administration. Thus, we investigated the effect of deleting the ankyrin receptor gene on the chronic nitroglycerin-induced mechanical sensitization and in males and females. To assess this, wild-type and TRPA1 knock out mice were subjected to the repeated nitroglycerin treatment and mechanical sensitivity was assessed at specific time points (**Figure 29**).

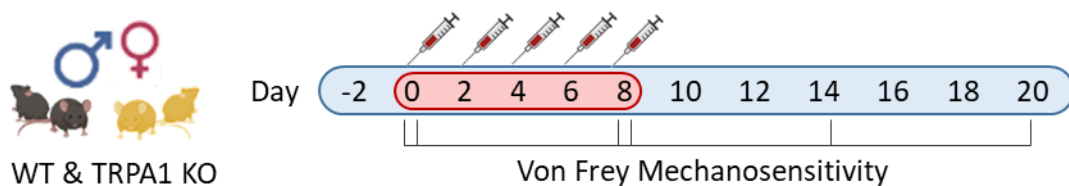

Figure 29 Protocol to unveil the importance of TRPA in our nitroglycerin migraine model, male and female mice of wild-type and TRPA1 knock out were treated with five nitroglycerin injections, and their mechanical sensitivity was assessed by von Frey filaments in the hind paws.

TRPA1 KO mice did not develop acute mechanical sensitization regardless of the sex (**Figure 30A**) ($p > 0.05$ vs. vehicle). These results are in harmony with a previous study describing lack of acute nitroglycerin sensitization in TRPA1 knockout males²⁰⁵. We could corroborate that this effect extended into the chronic state, as TRPA1 KO did not develop hypersensitivity in the long term ($p > 0.05$ vs. vehicle) (**Figure 30B**). This experiment confirms that TRPA1 is needed for nitroglycerin acute and chronic sensitization.

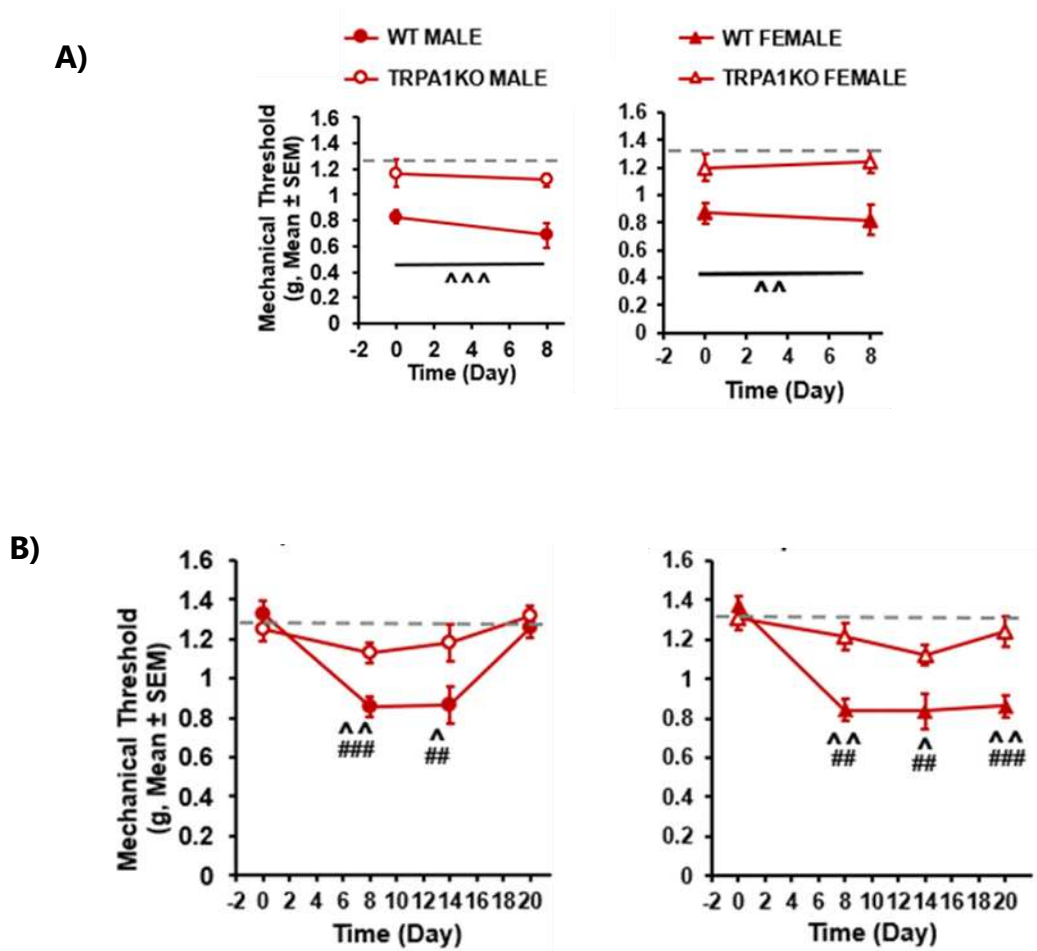

Figure 30 TRPA1KO mice are insensitive to nitroglycerin treatment. **A)** TRPA1KO prevents acute hypersensitivity. TRPA1KO animals treated with nitroglycerin did not present the evident sensitization two hours after injection, regardless of the sex. **B)** TRPA1KO prevents chronic hypersensitivity. TRPA1KO males and females did not develop the characteristic chronic sensitization after repeated nitroglycerin doses. Results presented as mean \pm S.E.M. (A & B) $^{\wedge}$ p<0.05, $^{\wedge\wedge}$ p<0.01, $^{\wedge\wedge\wedge}$ p<0.001 vs vehicle. $\#$ p<0.05, $\#\#$ p<0.01 vs baseline, 2-way RM ANOVA, n=6 per condition.

2. TRPA1 IS A FAST NITROGLYCERIN RESPONDER

Given the relevance of TRPA1 in the response to nitroglycerin, we studied the relationship between nitroglycerin and TRPA1 in cellular models. TRPA1 is known to be activated by NO_2 , and nitroglycerin is a donor of such a molecule²⁰⁵. Thus, we investigated if nitroglycerin could activate TRPA1 in murine cultures of trigeminal neurons. We performed primary trigeminal cultures and conducted calcium imaging (**Figure 31A**). Cultures from wild-type animals revealed a subset

of neurons that presented calcium transients in response to nitroglycerin 100 μ M and AITC 100 μ M, while cultures made from TRPA1 KO mice lacked these calcium transients in response to both stimuli (**Figure 31A**, left panel), in line with results obtained elsewhere²⁰⁵. The percentage of neurons responding to these TRPA1-related stimuli was of 15% ($p < 0.01$ WT vs. TRPA1KO) (**Figure 31B**, right panel). Therefore, TRPA1 is necessary for trigeminal neuron activation in response to nitroglycerin, explaining why TRPA1 knockout mice lack nitroglycerin acute and chronic sensitization.

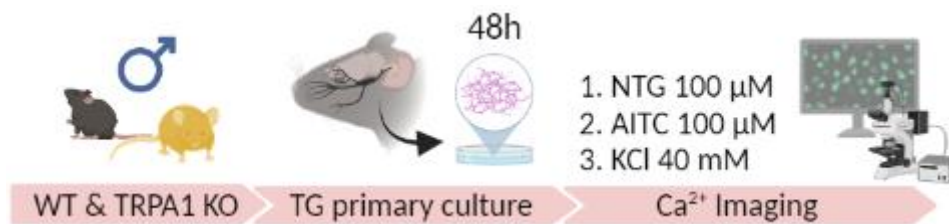

Figure 31 *In-vitro* study of the implication of TRPA1 in nitroglycerin response A) Protocol.

Cultured primary trigeminal neurons from wild-type and TRPA1 KO mice. After 48 hours of incubation, neuronal activity was monitored by calcium imaging. TRPA1-expressing cells were first identified by applying the agonist AITC 70 μ M then we applied nitroglycerin 100 μ M, in the perfusion to see if it presented agonistic activity. Finally, KCl 40 mM was applied as a positive neuronal control.

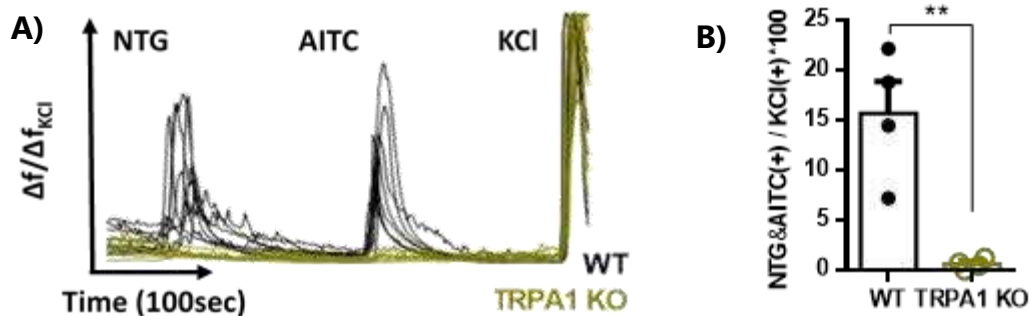

Figure 32 nitroglycerin activates TRPA1 A) Representative calcium traces of the aforementioned experiment. Neurons responding to nitroglycerin 100 μ M were also responsive to AITC 100 μ M. These responses were abolished in trigeminal cultures from TRPA1 knockout mice. **B) Percentage of neurons responding** to nitroglycerin and AITC. Around 15% of trigeminal neurons were sensitive to both stimuli in wild-type mice whereas only 1-2% were responsive in TRPA1 knockout mice. Mean calcium fluorescence increment \pm S.E.M. Data points represent independent experiments. $**p < 0.01$ Mann-Whitney U $n=5$; black traces represent wild-type and ochre ones TRPA1 KO.

3. TRPA1 EXPRESSION AND ACTIVITY IS INCREASED IN TRIGEMINAL GANGLIA AFTER NITROGLYCERIN TREATMENT

In-vivo procedures showed that TRPA1 determined the acute and chronic hypersensitivity after nitroglycerin treatments, and *in-vitro* experiments clarified its role as a nitroglycerin/NO target. Given TRPA1 importance, we considered the possibility that TRPA1 played a differential role between sexes in our nitroglycerin model of chronic migraine. Thus, we studied TRPA1 mRNA expression levels in the trigeminal ganglia of male and female mice chronically treated with nitroglycerin or its vehicle, to determine whether differential expression levels could explain sexual dimorphism of our migraine model (**Figure 33**). The results showed that male and female mice treated with vehicle had similar TRPA1 expression. Furthermore, there was an increase in TRPA1 mRNA expression in male and female mice treated with nitroglycerin when compared with the vehicle-treated animals (**Figure 34**) ($p < 0.001$ vs. vehicle). However, the increased TRPA1 expression was similar between sexes ($p > 0.05$ between sexes).



Figure 33 Chronic nitroglycerin exposure increases trigeminal *trpa1*. A) Protocol. Male and female wild-type animals were subjected to the chronic migraine model, at the end of the protocol trigeminal ganglia were extracted and RNA was purified. RT was performed with trigeminal mRNA and resulting cDNA was used to perform qPCR against TRPA1.

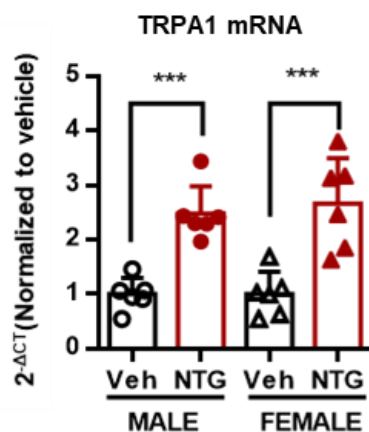

Figure 34 Increased mTRPA1 expression in both sexes. Trigeminal ganglia of male and female mice chronically exposed to nitroglycerin (red) show increased TRPA1 mRNA expression when compared to vehicle-treated mice (black). Mean expression \pm S.E.M. datapoints represent independent experiments. *** $p < 0.001$ 2-way ANOVA, $n = 5-6$ nitroglycerin, nitroglycerin. Veh, vehicle.

Similar TRPA1 mRNA expression between sexes may not mean equal activity of the receptor, since its activity could be increased at the translational and posttranslational levels. Thus, we performed trigeminal cultures of male and female animals subjected to the migraine model (**Figure 36A**), and challenged the cultured neurons with the TRPA1 agonist AITC. Notably, we could observe increased calcium transients in response to the TRPA1 agonist AITC after nitroglycerin treatment in both sexes ($p < 0.001$ vs. vehicle) (**Figure 36B**).

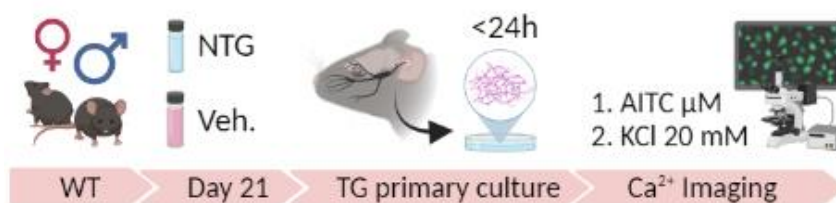

Figure 35 Trigeminal TRPA1 activity was increased after nitroglycerin treatment. A) Protocol. Wild-type male and female adult mice were subjected to the chronic nitroglycerin treatment, at the end of the protocol we performed trigeminal ganglia cultures and calcium imaging. (*Continued in next page*)

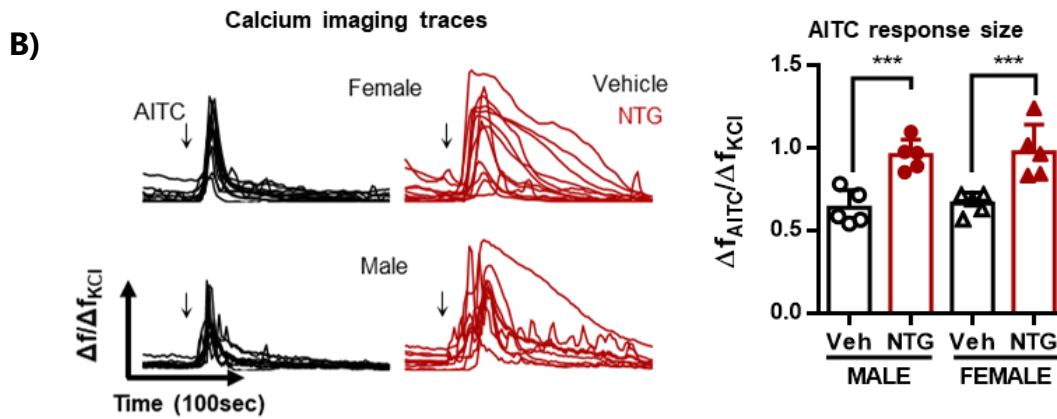

Figure 36 Trigeminal TRPA1 activity was increased after nitroglycerin treatment. B) Representative calcium traces in response to AITC 70 μ M normalized to KCl 40 mM. **C) Calcium response size quantification.** AITC responses are increased in cultures from nitroglycerin-treated animals regardless of the sex. *Mean calcium fluorescence response \pm S.E.M. Data points represent independent experiments. *** $p < 0.001$ 2-way ANOVA, $n = 5-6$. Ntrigeminal, nitroglycerin. Veh, vehicle.*

Trigeminal cultures from nitroglycerin-treated animals presented an increased percentage of AITC responding neurons when compared with cultures from vehicle-treated animals. Specifically, the percentage of AITC-responding neurons went from 17,2% \pm 3.1 to 23.8 \pm 2.4 in males and 18.6 \pm 1.6 to 24,2 \pm 1.8 in females (p0.001 vs. vehicle).

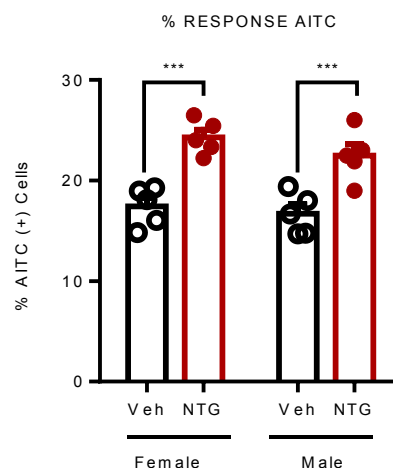

Figure 37 Percentage of TPA1 responding neurons increased in both sexes after Ntrigeminal administration. Percentage of AITC-sensitive neurons defined by their sensitivity to KCl is similarly increased in cultures from male and female nitroglycerin-treated mice. *** $p < 0.001$, 2-way ANOVA, $n = 5$.

To discriminate if the increased AITC responsiveness was produced in a neuronal subpopulation distinguishable by size, the area of all registered neurons was organized in two groups: responding and non-responding (**Figure 38**). AITC-responding neurons was small to medium sized and the increased percentage of AITC-sensitive neurons was spread across all the distribution between 200 and 600 μm^2 .

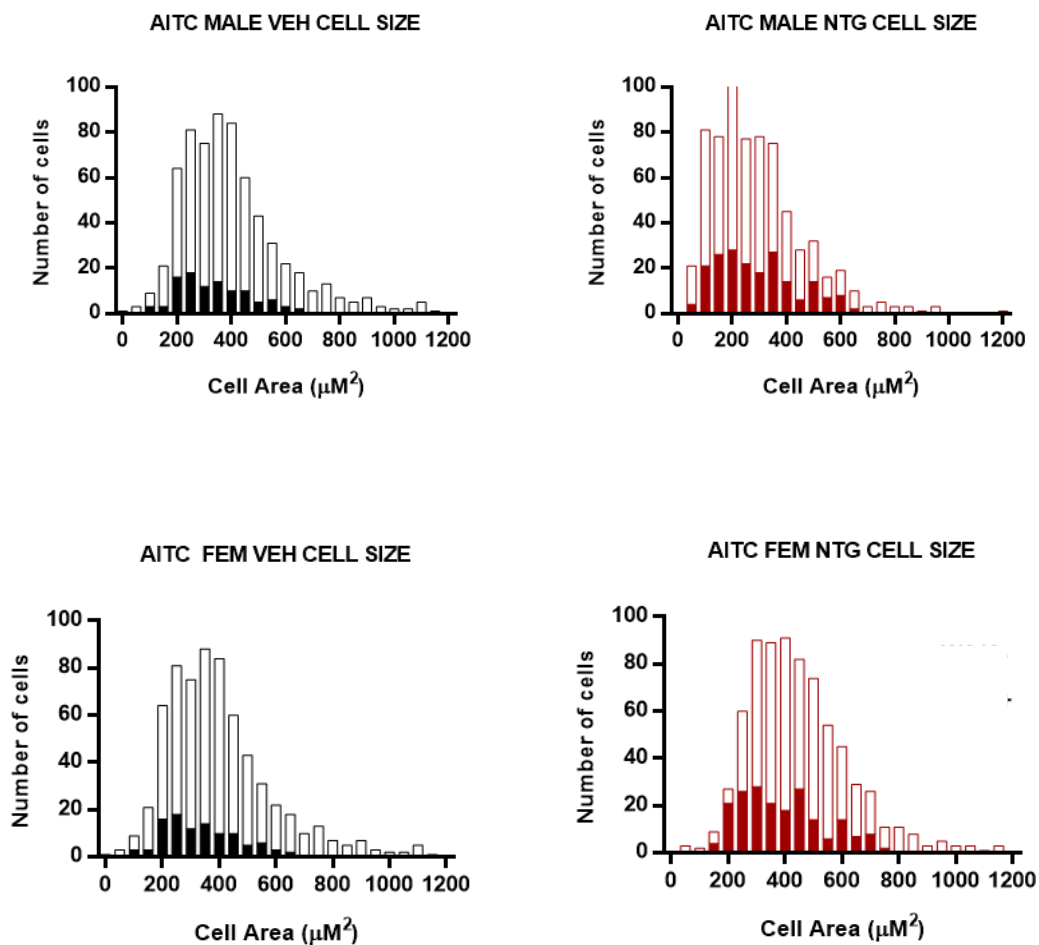

Figure 38 AITC activates small to medium-sized neurons in trigeminal cultures. Distribution of trigeminal neurons in culture, cells were distributed in AITC responding (filled bars) and AITC non responding (empty bars) neurons. In each graph, filled bar represents AITC, black graphs represent cultures from vehicle-treated animals and red graphs represent cultures from nitroglycerin-treated animals. Both male and female results show that AITC sensitive cells are mainly small and medium sized cells (200-600 μm^2), the increase in response is produced by cells along all this distribution.

In summary, nitroglycerin produces TRPA1 activation in small to medium-sized trigeminal neurons, and this activity drives mechanical hypersensitivity in the chronic nitroglycerin model. TRPA1 activity and expression is similarly increased after chronic nitroglycerin administration in male and female mice, thus does not seem responsible for the sex dimorphism observed in our model.

3. NITROGLYCERIN MEDIATES CGRP RELEASE

As it has been previously described, migraine is CGRP dependant. In fact, promising new treatments target CGRP molecule or receptor through the use of antibodies. We investigated the importance of CGRP neuropeptide by performing the nitroglycerin chronic model on CGRP knockout mice. Interestingly, CGRP knockout animals did not present any mechanical hypersensitivity during nitroglycerin treatment (**Figure 39**). Indicating that CGRP release is needed for the sensitization obtained in this migraine model.

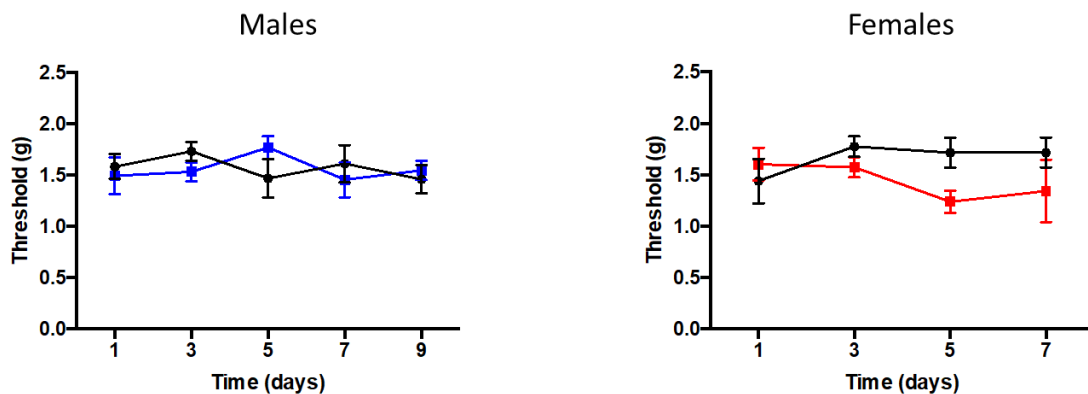

Figure 39 Nitroglycerin injection did not produce mechanical sensitization in CGRP knockout mice regardless of the sex. Mechanical sensitivity measurements showed that nitroglycerin treatment of male and female CGRP knockout animals did not produce sensitization when compared with vehicle treated mice. n=6 2-way ANOVA

Since TRPA1 is one of the TRP channels expressed in peptidergic C nociceptors, which activation induces CGRP release, we studied if nitroglycerin is a nociceptive stimulus capable of releasing this neuropeptide. For this, we performed a trigeminal culture, and exposed cells to nitroglycerin and the exocytosis inhibitor (DD047107) or its vehicle (**Figure 41A**), then we assessed the content of CGRP inside the cultured neurons by immunocytochemistry. Neurons exposed to nitroglycerin presented a decrease in CGRP immunoreactivity when compared to control neurons (**Figure 41C**, $p < 0.001$ vs. *nitroglycerin vehicle*). Interestingly, neurons pretreated with the exocytosis inhibitor DD04107, did not present

significant decrease of CGRP when compared to vehicle ($p > 0.05$ vs. nitroglycerin vehicle).

A)

Group	First incubation (60 min)	Second incubation (30 min)
1. Basal condition	DD04107 vehicle	NTG vehicle
2. CGRP release	DD04107 vehicle	NTG
3. Inhibition of CGRP release	DD04107	NTG + DD04107

B)

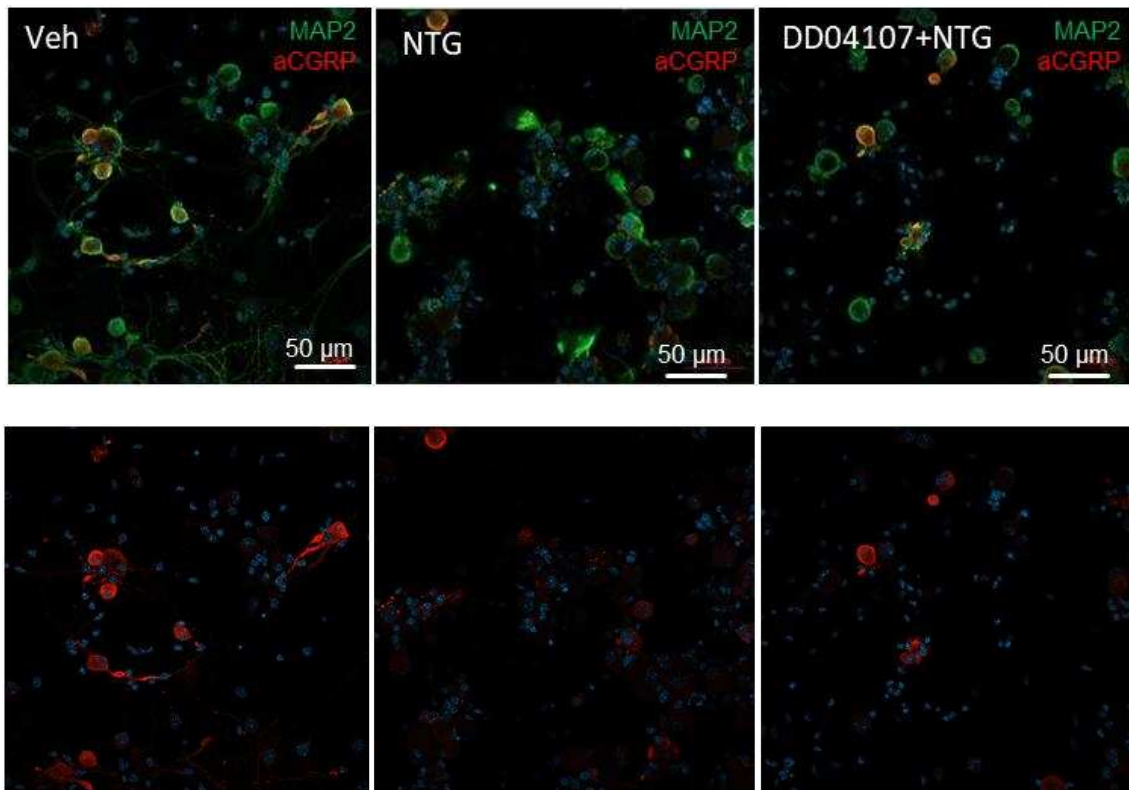

Figure 40 Nitroglycerin elicits CGRP release from trigeminal neurons. A) Protocol. We performed trigeminal culture, after 48 h the cells were treated for 1h with the exocytosis inhibitor DD04107 or its vehicle and finally nitroglycerin 100 μ M was added to the cultures for 30 minutes. Cultures were then processed for immunocytochemistry, neurons were marked with rabbit antiMAP2 antibody and labelled with goat anti-rabbit green secondary antibody. CGRP was marked with mouse antiCGRP and labelled with goat anti-mouse red secondary antibody. **B) Representative images from study groups**, first row of images include MAP2 (green) and CGRP (red), while the second one only presents CGRP labelling for clearer view. (*Continued in next page*)

C)

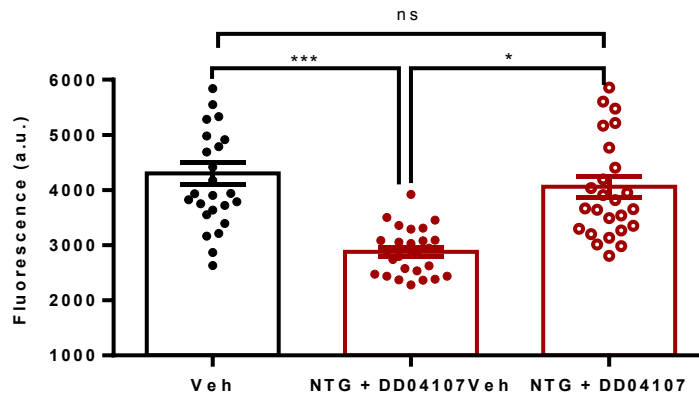

Figure 41 Nitroglycerin elicits CGRP release from trigeminal neurons. C) Red fluorescence quantification, NTG exposure produces a decrease in red fluorescence when compared with the NTG vehicle, this decrease can be partially prevented with the exocytosis inhibitor DD04107. Mean red fluorescence \pm S.E.M. Data points represent the mean red fluorescence for one image ($n > 30$). * $p < 0.05$, *** $p < 0.001$, one-way ANOVA.

We also checked the effectiveness of exocytosis inhibitor on mice subjected to the nitroglycerin treatment, on day 9 after the last nitroglycerin injection animals were treated with 3 mg/kg of DD04107 peptide (**Figure 42**). Animals treated with the peptide rapidly recovered their basal sensitivity values, indicating that CGRP is needed for the maintenance of the sensitized state.

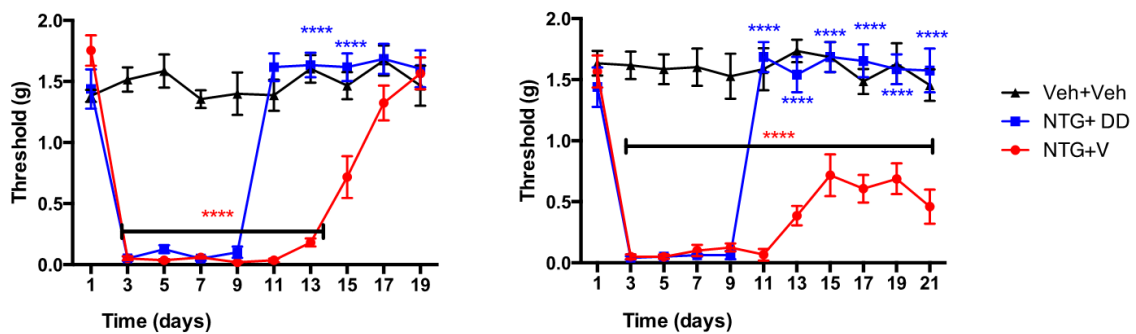

Figure 42 Exocytosis inhibitor DD04107 precipitates a rapid recovery of mechanical sensitization in male and female mice treated with nitroglycerin. Animals subjected to the chronic nitroglycerin treatment that were treated with 3 mg/kg of exocytosis inhibitor recovered sensitivity to basal values regardless of the sex. Mean \pm S.E.M.

In summary, in a previous work we uncovered that CGRP neuropeptide was essential for long term sensitization in our nitroglycerin chronic migraine model, with no difference between sexes. Thus, blocking of CGRP exocytosis with the novel molecule DD04107 prevents chronic sensitization. *In-vitro* experiments confirmed that nitroglycerin is a stimulus capable of CGRP exocytosis, which could be blocked by exocytosis inhibitor DD04107.

4. ROLE OF TRPV1 IN THE MIGRAINE MODEL

1. NITROGLYCERIN TREATMENT DID NOT PRODUCE TRPV1 INCREASED FUNCTIONALITY

TRPV1 has been linked to migraine models and other trigeminal sensitization alterations²¹³, we wanted to study the possibility that TRPV1 activity was increased in trigeminal ganglia of female mice treated with nitroglycerin. Percentage of neurons responding to different capsaicin concentrations (10 nM and 1 μ M) showed no difference between females treated with nitroglycerin and vehicle.

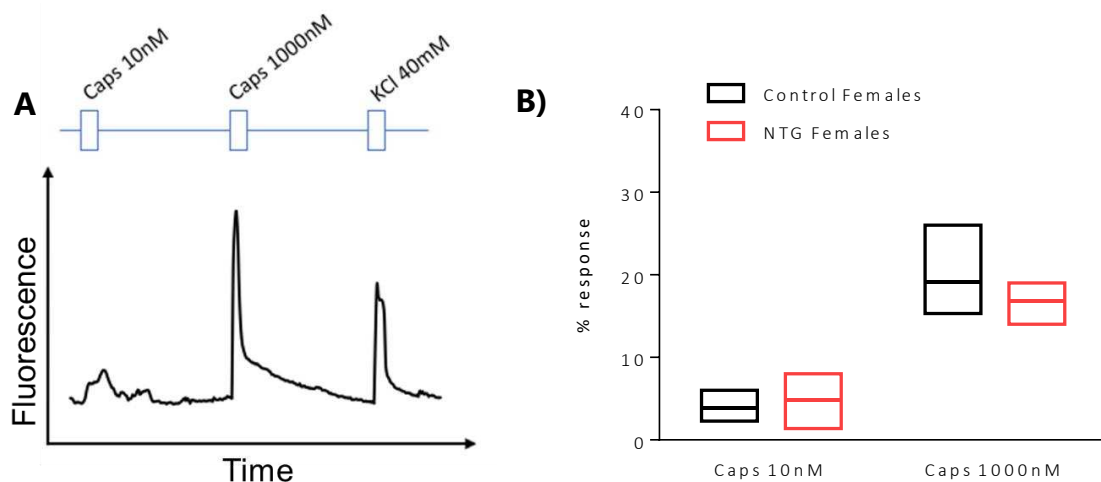

Figure 43 Nitroglycerin treatment did not produce alterations in activation of TRPV1 *in-vitro*. As females presented persistent sensitization, we decided to study the possibility that TRPV1 activity was increased in trigeminal ganglia of female mice treated with nitroglycerin. **A)** representative trace of calcium responses to capsaicin 10 nM and 1 μ M. **B)** Percentage of responding neurons showed no difference between nitroglycerin and vehicle treated animals n= 4 per condition, T test.

2. ACUTE NITROGLYCERIN DOES NOT POTENTIATE TRPV1 ACTIVITY *IN-VITRO*

It has been described that TRPA1 and TRPV1 are strongly co-expressed, and activation of TRPA1 could lead to TRPV1 potentiation through local calcium increase²⁴⁸ and mobilization of large dense core vesicles, recruiting more TRPV1 to the plasma membrane²⁵. In our migraine model nitroglycerin activates TRPA1 and this could produce TRPV1 potentiation, contributing to the sensitization produced by nitroglycerin. To study cross-potential between the two TRPs, trigeminal ganglia cultured neurons were challenged with four pulses of capsaicin as a TRPV1 agonist with a nitroglycerin 100 μ M application between the second and third pulses (**Figure 44**). This experiment was performed with male and female mice. Capsaicin responsive neurons majorly also responded to nitroglycerin, as it was expected due to TRPA1-TRPV1 expression (**Figure 45A**).

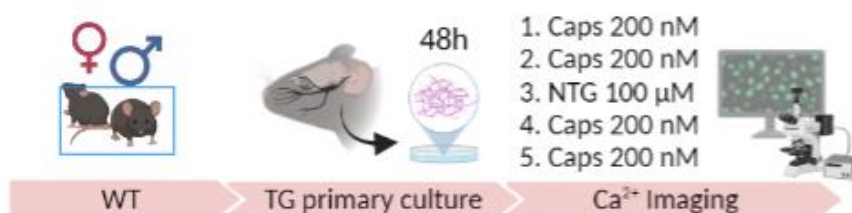

Figure 44 Experiment design to study nitroglycerin TRPA1-dependent TRPV1 potentiation.

Trigeminal culture from male and female mice were challenged with four capsaicin 200 nm applications intercalated by NTG 100 μ M.

Quantification of the potentiation was obtained by a division of the calcium response to the 4th capsaicin pulse by the response to the 1st one. Comparison of the normalized 4th response showed no difference between nitroglycerin and vehicle experiments, nor between sexes. Nitroglycerin does not present a fast potentiation of TRPV1 after activating TRPA1 (**Figure 45B**).

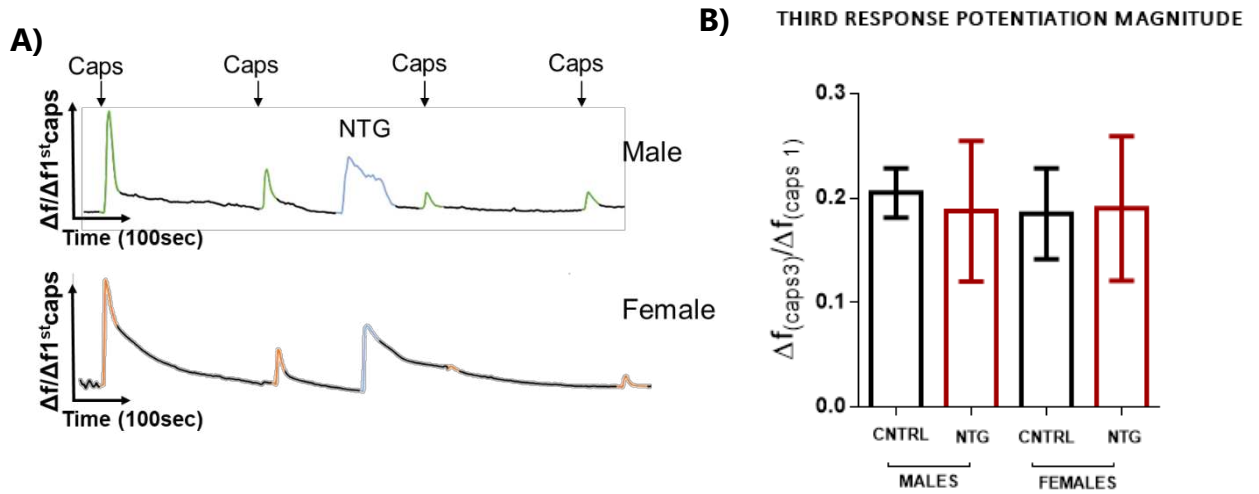

Figure 45 Nitroglycerin does not potentiate the activity of TRPV1 **A)** Calcium traces from male and female cultures in response to capsaicin and nitroglycerin. **B)** Mean calcium fluorescence increment \pm S.E.M. Data points represent independent experiments. Mann-Whitney U n=5; Black represents vehicle treated, and red nitroglycerin treated cultures.

3. NITROGLYCERIN TREATMENT DID NOT PRODUCE INCREASED *IN-VITRO* POTENTIATION OF TRPV1

Given the relevance of CGRP in potentiation mechanisms, we studied if treated animals presented a stronger potentiation for TRPV1, which had been extensively characterized in our laboratory. It has been described that P2X and bradykinin receptors can be overexpressed in trigeminal sensitization²⁴⁹. So we performed a protocol to study bradykinin and APT mediated TRPV1 potentiation, to assess whether if sensitization in the migraine model was accompanied by increased TRPV1 potentiation. We could

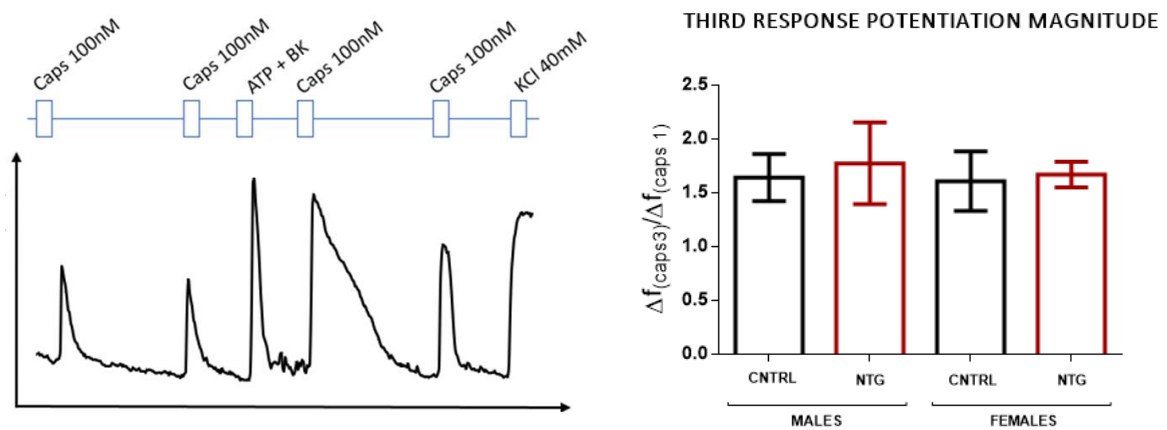

Figure 46 Nitroglycerin treatment did not increase in-vitro potentiation of TRPV1 by ATP and bradykinin receptor, but it increased response to ATP and bradykinin. A) Protocol applied to trigeminal culture neurons, third pulse of capsaicin was potentiated by ATP 10 μ M + bradykinin (BK) 100 μ M. B) Nitroglycerin treatment did not produce a potentiation increase of capsaicin responses after ATP + bradykinin. Mean calcium fluorescence increment (3/1) \pm S.E.M. Data points represent independent experiments. One-Way ANOVA, n=5; Black represents vehicle treated, and red nitroglycerin treated cultures.

In summary, TRPV1 activity was not increased in trigeminal cultures from female mice treated with repeated nitroglycerin injections. Acute application of nitroglycerin did not potentiate TRPV1 activity in culture. Female animals treated with nitroglycerin did not present a stronger TRPV1 potentiation in response to sensitizers ATP and bradykinin.

5. ROLE OF TRPM8 IN THE MIGRAINE MODEL

1. TRPM8 ACTIVITY DETERMINES THE RECOVERY OF NORMAL SENSITIVITY IN MALE MICE

Association of TRPM8 variants and migraine prevalence¹⁸⁹ and the antimigraine effect of TRPM8 agonists^{220,221} point the melastatin receptor as an interesting target in our chronic migraine model^{217–219}. Thus, we studied wild-type and TRPM8 knockout male and female mice under the repeated nitroglycerin administrations (**Figure 48A**). Knockout mice of either sex presented a normal acute sensitization in response to nitroglycerin administration (**Figure 48B**, $p > 0.05$ vs. wild-type). Regarding long lasting sensitization, wild-type animals developed the expected hypersensitivity; males presented low mechanical thresholds on days 8 and 15 (**Figure 48C**, < 0.01 vs. Baseline) that had recovered normal values at day 20. Surprisingly, TRPM8 knockout males maintained a persistent sensitization as the one observed in females (**Figure 48C**, $p < 0.01$ vs vehicle at day 20). These results reveal a protective function of the melastatin 8 channel in males under repeated nitroglycerin administration, which could play a role in sex dimorphism of the model of chronic migraine.

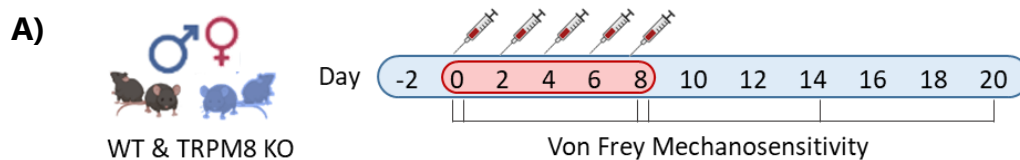

Figure 47. TRPM8 allows wild-type males to recover basal values after nitroglycerin injections. A) Protocol. wild-type and TRPM8 knockout were subjected to the nitroglycerin treatment, and their mechanical sensitivity was measured by von Frey. (*Continued in next page*)

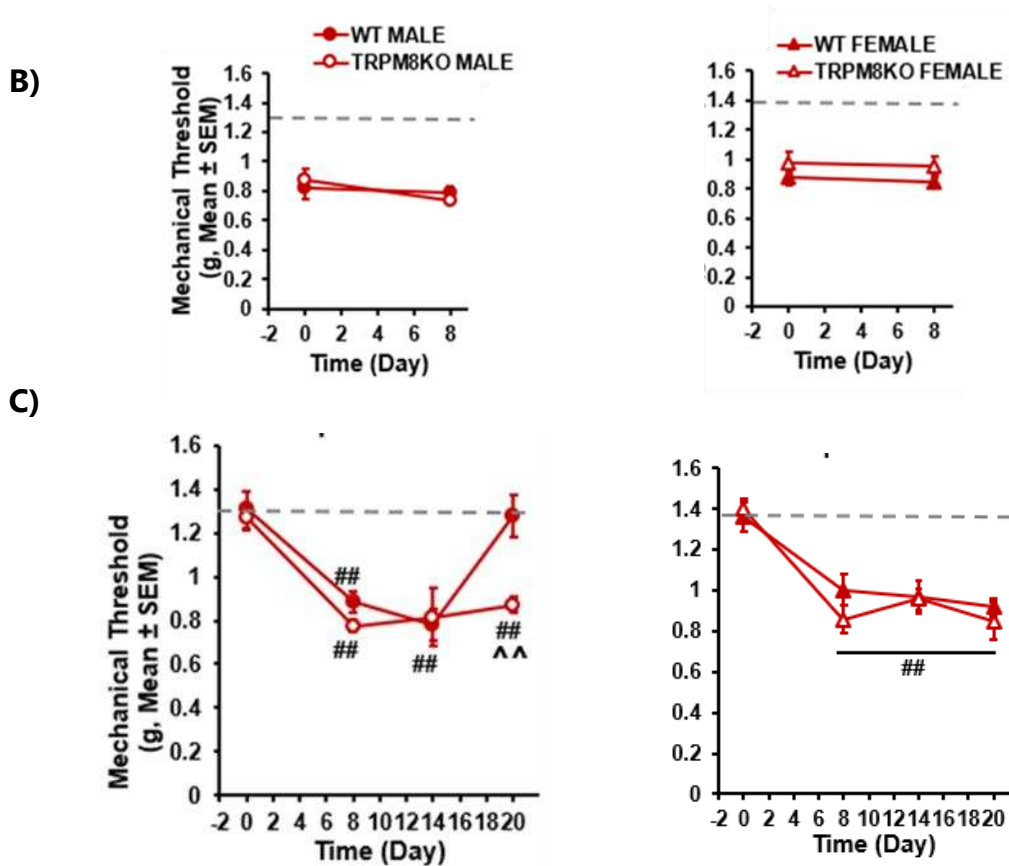

Figure 48. TRPM8 allows wild-type males to recover basal values after nitroglycerin injections. **B) Acute response.** Wild-type and trpm8 knockout males and females display similar acute mechanical hypersensitivity after nitroglycerin treatment. **C) Chronic response.** TRPM8 wildtype males treated with NTG develop mechanical hypersensitivity that can be recorded at days 8 and 15 but is resolved by day 20. In the case of females, both genotypes present similar behaviour and TRPM8 knockout females developed the expected long lasting sensitization. *Mean mechanical thresholds ± S.E.M.## p<0.01 vs baseline. ^p<0.01 vs vehicle 2-way RM ANOVA, n=6*

2. TRIGEMINAL TRPM8 DOES NOT PRESENT DIFFERENCES BETWEEN SEXES

Given the relevance discovered of TRPM8 for the sexual dimorphism shown in our migraine model, we studied the expression and activity of TRPM8 in trigeminal ganglia, looking for traits alterations that could explain the observed sex differences. First we isolated and studied mRNA of TRPM8 mRNA expression channel in trigeminal ganglia of wild-type male and female adult mice subjected to the nitroglycerin model. Upon the end of the experiment, we extracted RNA from trigeminal ganglia of the mice and performed mRNA

retrotranscription followed by a qPCR for TRPM8 channel (**Figure 49A**). TRPM8 mRNA values were similar among sexes, and the nitroglycerin treatment did not produce significant changes in its expression (**Figure 49B**) ($p > 0.05$ vs. vehicle and between sexes).

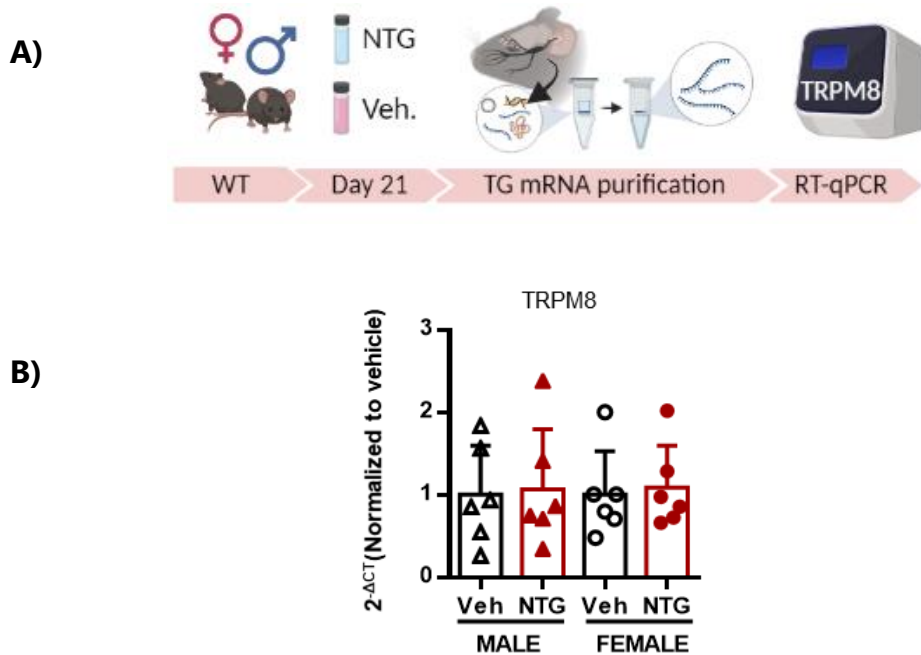

Figure 49 TRPM8 expression is similar between sexes and not altered by nitroglycerin treatment. **A) Protocol.** Male and female wild-type animals were subjected to the chronic migraine model, at the end of the protocol trigeminal ganglia were extracted and RNA was purified. mRNA molecules were retrotranscribed and resulting cDNA was used to perform qPCR against TRPM8. **B) Quantification.** Trigeminal ganglia of male and female mice chronically exposed to nitroglycerin (red) showed no TRPM8 mRNA expression modifications when compared to vehicle-treated mice (black). *Mean expression \pm S.E.M. Data points represent independent experiments. 2-way ANOVA, $n=5-6$.*

To investigate whether TRPM8 could respond differently in males and females in spite of the similar expression We we complemented the expression study with a functional onecalcium imaging, as we did for TRPA1. We first made trigeminal primary cultures form wild-type male and female animals subjected to the nitroglycerin chronic exposure. Then we studied calcium responses when challenged with the selective TRPM8 agonist WS12 (500 nM), and KCl 40 mM was

used as a positive control (**Figure 50A**). TRPM8 activity was similar across sexes and treatments (**Figure 50B**, $p > 0.05$ vs. vehicle and between sexes), meaning that nitroglycerin treatment didn't change this TRPM8 activity.

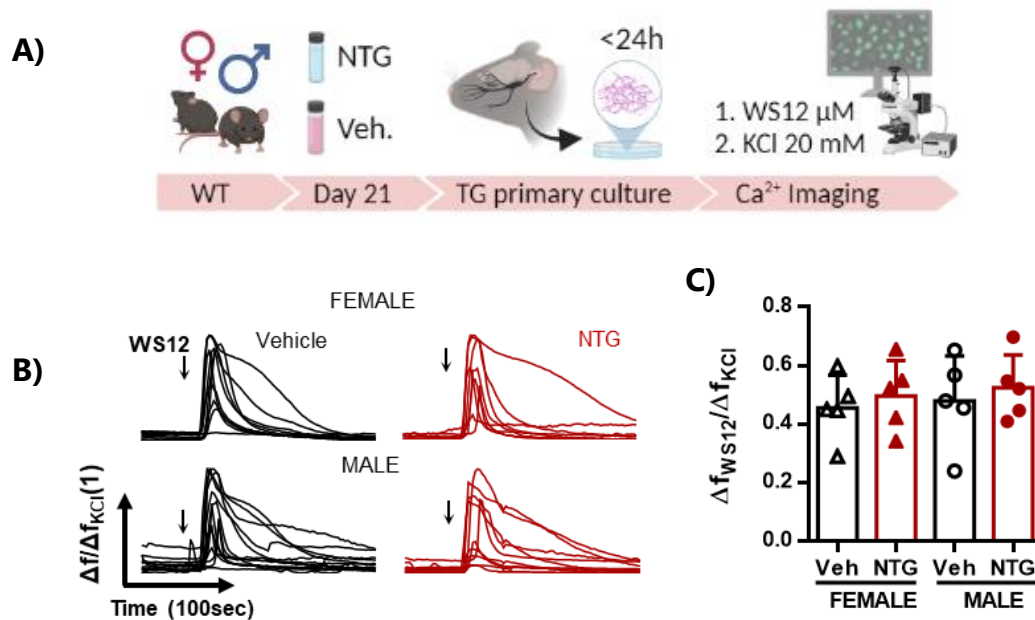

Figure 50 Trigeminal TRPM8 activity was not modified after nitroglycerin treatment. A) Protocol. Wild-type male and female adult mice were subjected to the chronic nitroglycerin treatment, at the end of the protocol we performed trigeminal ganglia cultures and calcium imaging. **B) Representative calcium traces** in response to WS12 500 nM normalized to KCl 40 mM. **C) Quantification of calcium response size.** WS12 responses were unaltered in cultures from nitroglycerin-treated animals of both sexes. *Mean calcium fluorescence response \pm S.E.M. Data points represent independent experiments. *** $p < 0.001$ 2-way ANOVA, $n = 6$.*

The percentage of WS12-responding neurons was around 8-9% in both sexes, with no significant differences after treatment. Then, we characterized the WS12 responding cell population by size, the area of all registered neurons was measured and cells were organized in two groups: responding and nonresponding. WS12-responding neurons were of small to medium size, from 150 to 300 μ M.

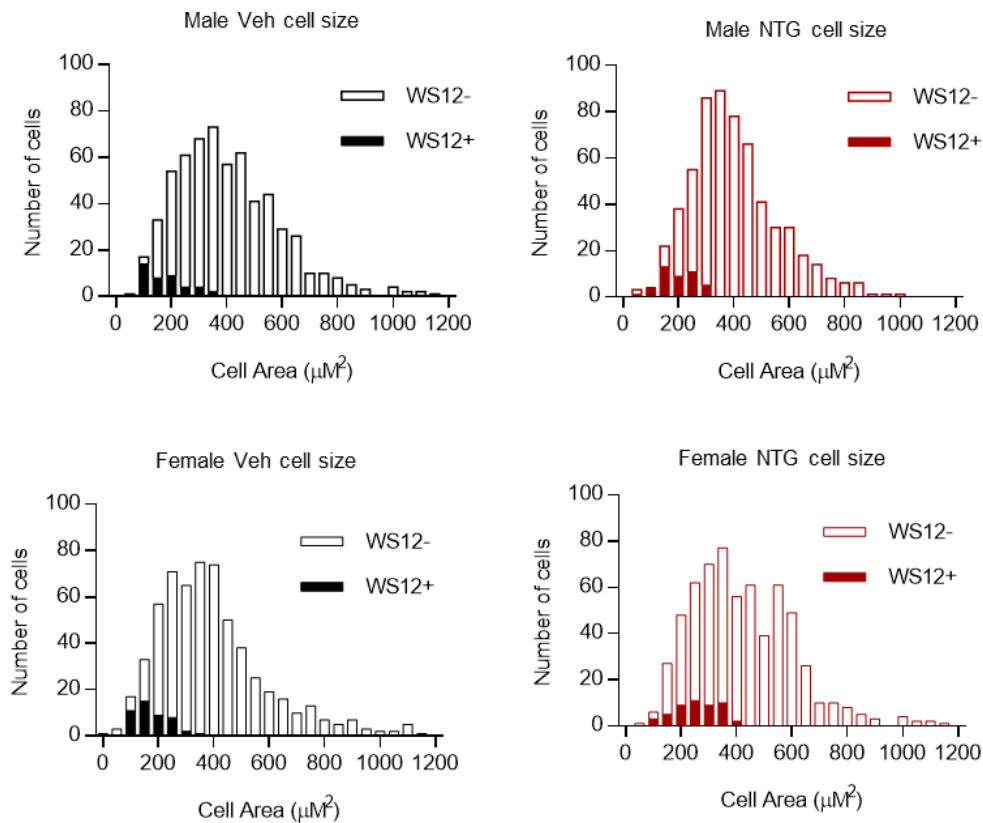

Figure 51 WS12 activates small to medium-sized neurons in trigeminal cultures.

Distribution of trigeminal neurons in culture, cells were distributed in WS12 responding (filled bars) and WS12 non-responding (empty bars) neurons. In each graph, filled bar represents WS12, black graphs represent cultures from vehicle-treated animals and red graphs represent cultures from nitroglycerin-treated animals. Both male and female results show that WS12 sensitive cells are mainly small sized cells, and no modification is observed by nitroglycerin treatment.

3. TRPM8 ACTIVITY SHOWS ANTINOCICEPTIVE EFFECT IN WILD-TYPE MICE SUBJECTED TO THE NITROGLYCERIN MODEL OF CHRONIC MIGRAINE

Since we could not find clear differences between sexes in TRPM8 expression or function, we about hypothesized about the existence of an endogenous TRPM8 activator that could explain its protective role in male mice. To asses this hypothesis, we performed an experiment to test the antinociceptive effect of TRPM8 in male mice subjected to the migraine model. At day 20 they had recovered their baseline sensitivity, animals were treated with increasing doses of TRPM8 blocker AMTB and we measured mechanical sensitivity two hours after injection (**Figure 52A**). AMTB at 10 or 15 mg/kg precipitated resensitization (**Figure 52A**, $p < 0.05$ vs vehicle).

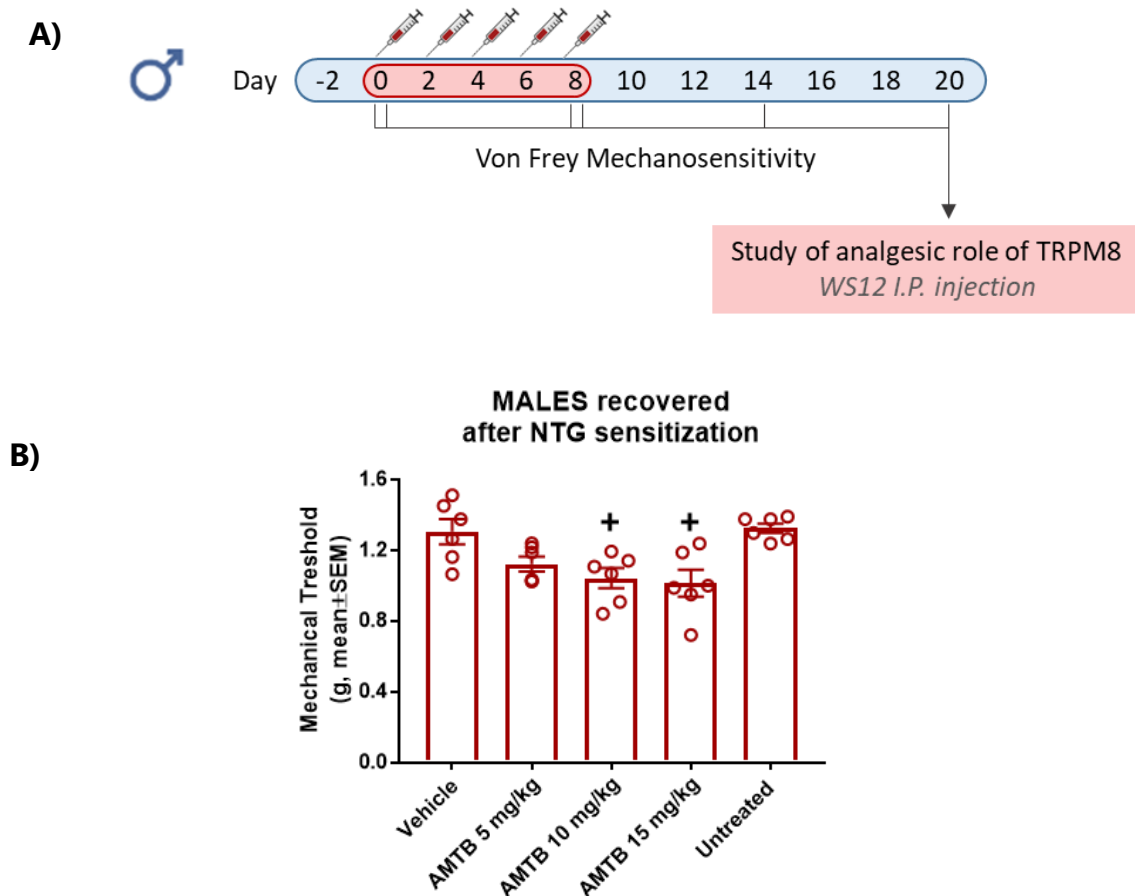

Figure 52. TRPM8 antagonism reinstates mechanical sensitization in males recovered from the chronic nitroglycerin treatment. **A) Protocol.** After the last measurement on day 20, animals were administered with different doses of AMTB or its vehicle and after 30 minutes their sensitivity was measured again. **B) Effect of AMTB on recovered males.** Administration of specific TRPM8 antagonist AMTB to mice chronically exposed to nitroglycerin that already recovered their basal sensitivity unmasks a latent mechanical pain sensitization. *Results are mean mechanical sensitivity values ± S.E.M. *** $p < 0.001$ nitroglycerin vs vehicle, 3-way ANOVA $n = 6-7$. + $p < 0.05$ vs vehicle Friedman Test $n = 6$.*

After the results with TRPM8 blocker AMTB in males, we tested if introducing an exogenous TRPM8 agonist could help female mice to recover their baseline sensitivity after the chronic nitroglycerin treatment (**Figure 53A**). Female mice treated with the TRPM8 agonist WS12 showed a tendency to improve their mechanical sensitivity (**Figure 53B**), although without significant differences.

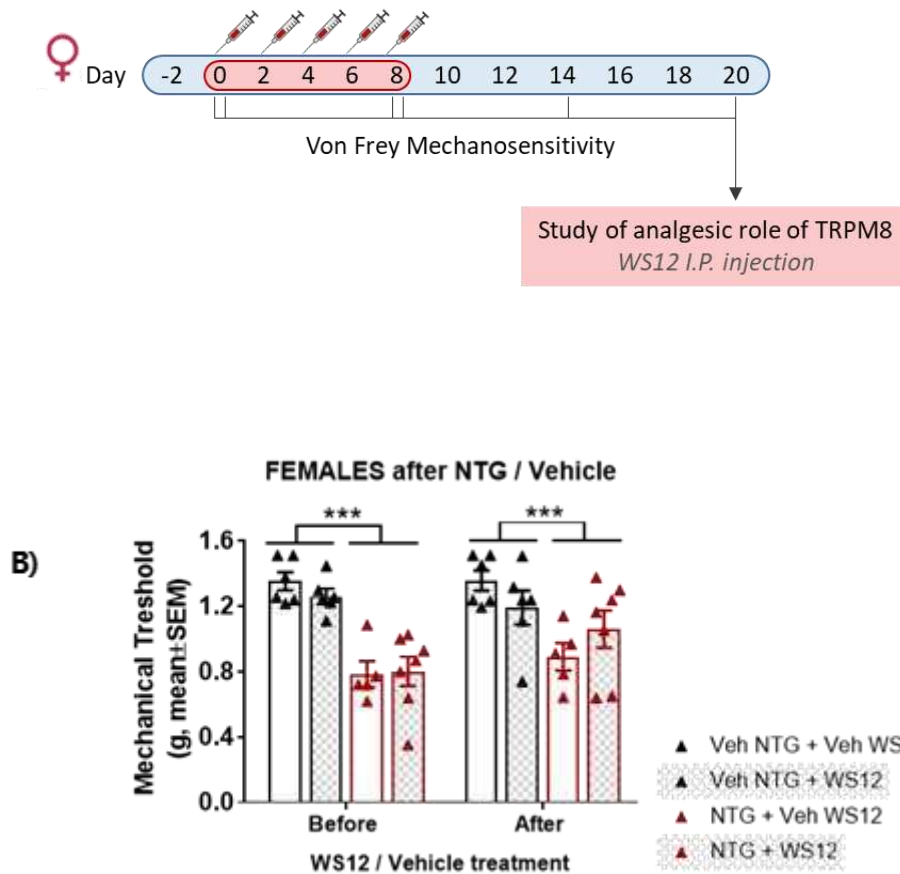

Figure 53 WS12 produces a tendency for recovery in nitroglycerin sensitized females.

A) *Protocol.* Female mice chronically exposed to nitroglycerin showed increased mechanical sensitivity when compared to vehicle-treated mice. B) This sensitivity could not be significantly alleviated after treatment with WS12 10 mg/kg. *Results are mean mechanical sensitivity values ± S.E.M. *** $p < 0.001$ nitroglycerin vs vehicle, 3-way ANOVA $n = 6-7$. + $p < 0.05$ vs vehicle Friedman Test $n = 6$.*

This experiment was repeated using WS12 at 5 mg/kg and 20 mg/kg of WS12, while the lowest dose had no effect on mechanical sensitivity, an antinociceptive trend could be observed after intraperitoneal injection of 20mg/kg (**Figure 54**, $P = 0.053$ vs. vehicle).

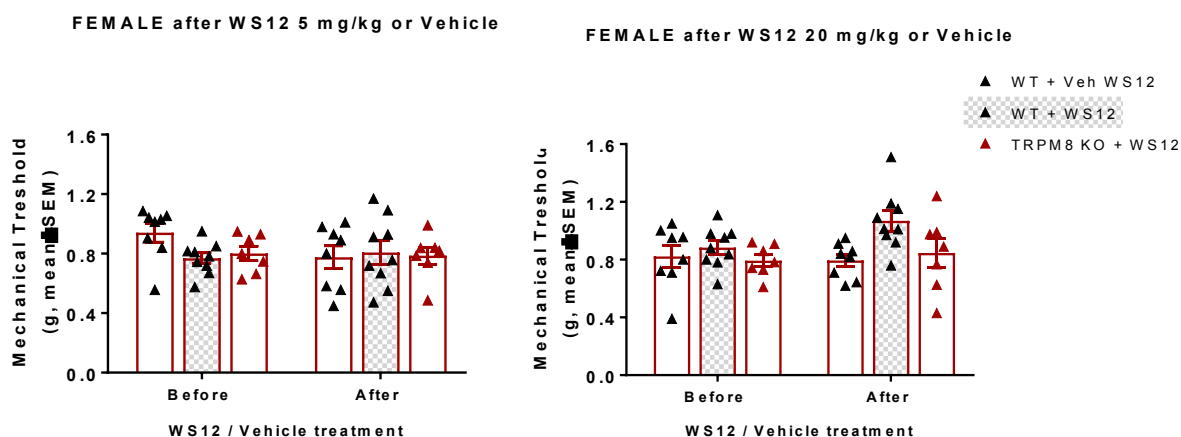
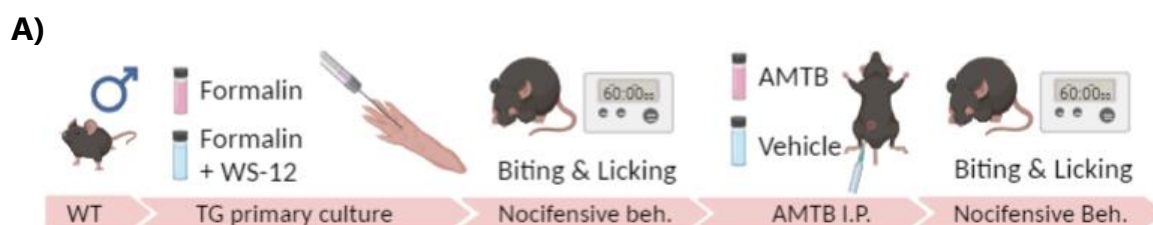

Figure 54 Effects of WS12 on mechanical hypersensitivity of nitroglycerin or vehicle-treated female. **A)** WS12 5 mg/kg or its vehicle (2.5% DMSO in corn oil) did not modify mechanical sensitivity of female mice chronically treated with nitroglycerin. **B)** WS12 20 mg/kg did not modify mechanical sensitivity of female mice chronically treated with nitroglycerin although a trend ($p=0.053$) was observed when comparing WS12 and vehicle-treated mice. Mean mechanical thresholds \pm S.E.M. (A, B) 2-way RM ANOVA $n=7-9$ per group., $n=6-7$ per group. NTG, nitroglycerin. Veh, Vehicle.

4. TRPM8 HAS POTENTIAL ANALGESIC EFFECT IN ANOTHER TRPA1-DEPENDENT PAIN MODEL

The antinociceptive effect of TRPM8 was also tried in the formalin test, another TRPA1-dependent pain model¹⁷³. Intraplantar formalin injection produces nocifensive behaviour characterised by licking, biting and shaking of the affected limb. This behaviour presents two different phases; the 1st pain starts some seconds after paw injection, where TRPA1 activation by formalin produces pain and then it stops around the ten-minute mark. The 2nd pain slowly builds up again and can last until an hour. A work in rats showed that pain persisted for an hour in males while it extended longer in females²⁹. To confirm the protective effect of TRPM8, males were injected in the paw with formalin, after one hour measuring nocifensive behaviour AMTB was injected i.p., the observation continued for another hour (**Figure 55A**). Male mice injected with AMTB after pain extinction showed a significant reinstatement of the nociceptive behaviour 30 minutes after administration (**Figure 55B**, $p < 0.05$ vs vehicle).



B)

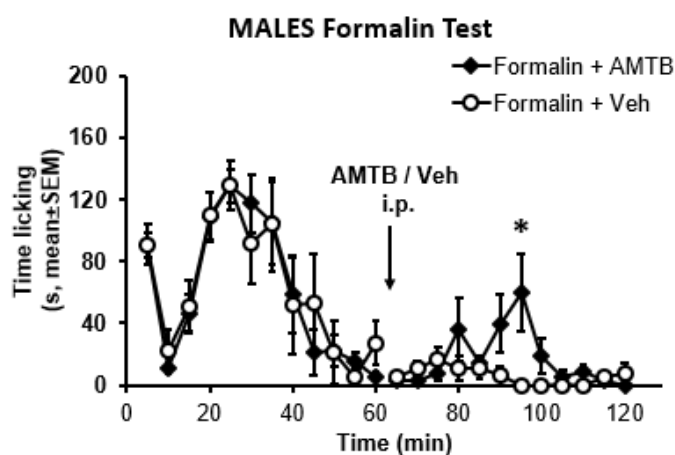
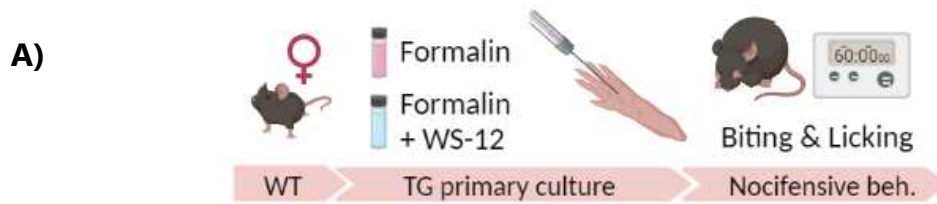

Figure 55 AMTB reinstates formalin-induced nocifensive behaviour in males. A) Protocol.

Male mice were injected with formalin in the right hind paw and nocifensive behaviour was measured for 1h, then mice received an i.p. injection of AMTB and behavioural observation was resumed for 1h. **B) AMTB unmasks formalin-induced pain in male.** AMTB 10 mg/kg administered 1 h after formalin injections induces significant reinstatement of licking and biting behaviour in male mice. *Mean nocifensive behaviour ± S.E.M. *p<0.05 vs vehicle. Multiple t-test n=5-6.*

n=5-6.

Similarly, to the migraine model, we wanted to test if the effect of an exogenous TRPM8 agonist in the formalin test. For this, female mice were con-injected with formalin and WS12 or its vehicle, and their nocifensive behaviour was measured for 1 hour (**Figure 56A**). We observed that nocifensive behaviour was less intense during the first phase in females treated with the TRPM8 agonist (**Figure 56B**, $p<0.05$ vs vehicle). Although it did not present significant differences, females treated with WS12 seem to present faster recovery than vehicle treated females.



B)

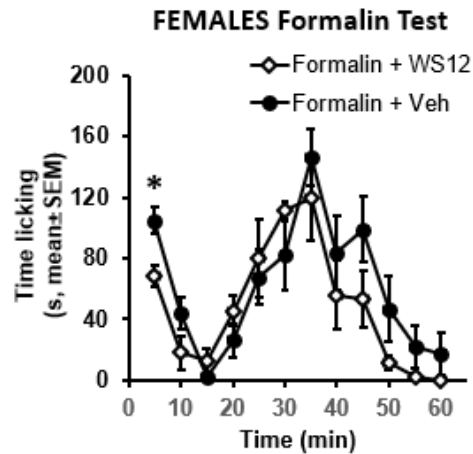

Figure 56 WS12 decreases formalin induced pain in female. A) Protocol. Female wild-type mice were injected with formalin plus WS12 (6 nM) or its vehicle (Cyclodextrin 45%), then licking and biting of the affected limb was counted for one hour. **B) Nocifensive behaviour** is significantly alleviated when females receive formalin co-injected with 6 nM WS12. Mean nocifensive behaviour ± S.E.M. (g) * <0.05 vs vehicle. Multiple t-test $n=6$ per condition.

In summary, TRPM8 plays a protective role in male mice exposed to the model of chronic migraine. Blockade of TRPM8 produces a rapid resensitization of already recovered males, which points to a possible latent sensitization masked by tonic activation of TRPM8 in male mice. This effect could be confirmed in a formalin pain model, that also depends on TRPA1, were TRPM8 agonism produced pain-relieving effects in males and females.

5. ROLE OF TESTOSTERONE IN THE MODEL OF MIGRAINE

1. TESTOSTERONE RELIEVES MECHANICAL SENSITIZATION IN MALE MICE EXPOSED TO NITROGLYCERIN

It has been suggested that testosterone works as an endogenous TRPM8 agonist^{187,188}, and it associated with better prognosis in men with migraine²³⁹. Thus, we hypothesized that the endogenous androgen could play an antinociceptive function in males in our nitroglycerin chronic pain model. Thus, we performed the von Frey measurements in orchidectomized and sham animals to study the relevance of gonadal testosterone (**Figure 57A**). Acute nitroglycerin administration elicited similar pain in both groups (**Figure 57B** $p < 0.001$ vs vehicle). But, orchidectomized animals presented a persistent chronic sensitization absent in the sham group (**Figure 57B**, $p < 0.001$ vs nitroglycerin vehicle, $p < 0.01$ vs sham). This result indicated a possible protective role of testosterone in our model of chronic migraine.

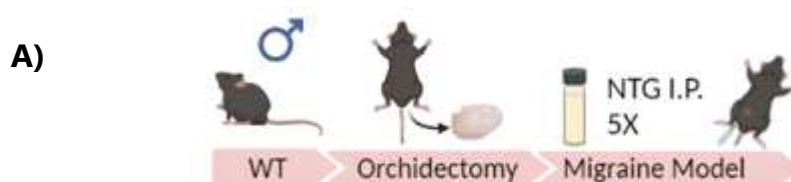

Figure 57 Gonadal testosterone presents a protective function in males treated with nitroglycerin. A) Protocol. Male mice were orchidectomized and two weeks later were subjected to the chronic nitroglycerin administration. (Continued in next page)

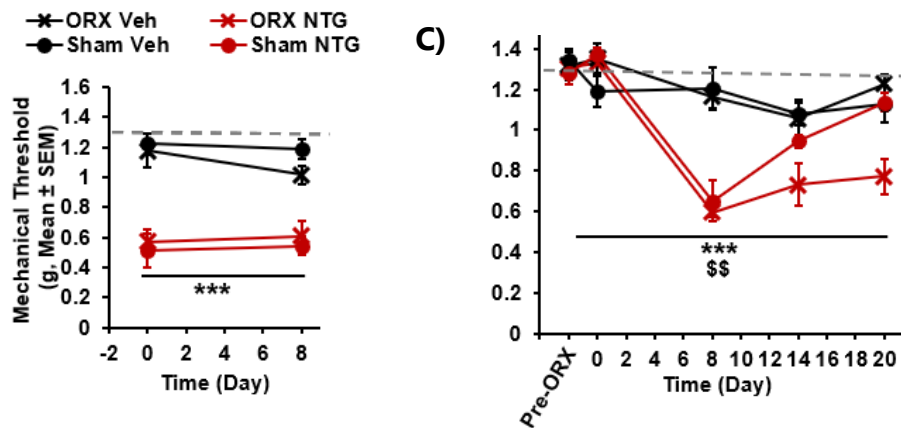

Figure 58 Gonadal testosterone presents a protective function in males treated with nitroglycerin. **B)** Orchidectomized animals treated with nitroglycerin present similar acute hypersensitivity after nitroglycerin when compared to sham animals. **C)** However, orchidectomized mice develop a persistent mechanical hypersensitivity. *Mean mechanical threshold ± S.E.M.* *** $p < 0.001$ vs nitroglycerin vehicle, \$\$ $p < 0.01$ vs sham, 3-way RM ANOVA. $n = 6$ Veh, vehicle. Testos, testosterone. Orx, orchidectomized

2. TRPM8-TESTOSTERONE INTERACTION PARTICIPATES IN THE MALE RECOVERY

In order to investigate the implication of TRPM8 in the possible antinociceptive effect of testosterone, we orchidectomized WT and TRPM8 knockout mice and after full recovery from the operation, mice were implanted with subcutaneous osmotic ALZET minipumps containing testosterone or its vehicle. Three days after minipump implantation, animals were subjected to the chronic nitroglycerin model and at day 21 after the last measurement they were treated with TRPM8 blocker AMTB (**Figure 60A**). TRPM8 knockout animal presented lower mechanical thresholds in the acute response at day 8 (**Figure 60B**, 0.01 vs wildtype). Regarding long lasting sensitization, testosterone induced complete recovery of mechanical thresholds in wild-type mice (**Figure 60C**, day 20, $P < 0.001$ vs. Vehicle wild-type, nonsignificant vs. baseline), while vehicle-treated animals remained sensitized by the end of the experiment (**Figure 60C**, $P < 0.001$ vs. baseline on day 20). Remarkably, TRPM8 knockout mice lacked this restorative effect of testosterone (**Figure 60C**, day 20, $P < 0.001$ vs. wild-type, $P < 0.001$ vs.

baseline), although an antinociceptive effect independent of TRPM8 activity was also evidenced in knockouts (**Figure 60C**, day 20, $P < 0.05$ vs. vehicle TRPM8 knockout). Finally, at day 21 these male mice were injected with AMTB to double-check the implication of TRPM8 in the positive effect of testosterone, this revealed that blocking TRPM8 in wild-type mice subjected to the nitroglycerin treatment and supplemented with testosterone produces a resensitization (**Figure 26D**, $P < 0.01$ vs. values before AMTB), pointing to the possibility of a latent sensitized state masked by some testosterone-TRPM8 interaction in wild-type male mice chronically treated with testosterone.

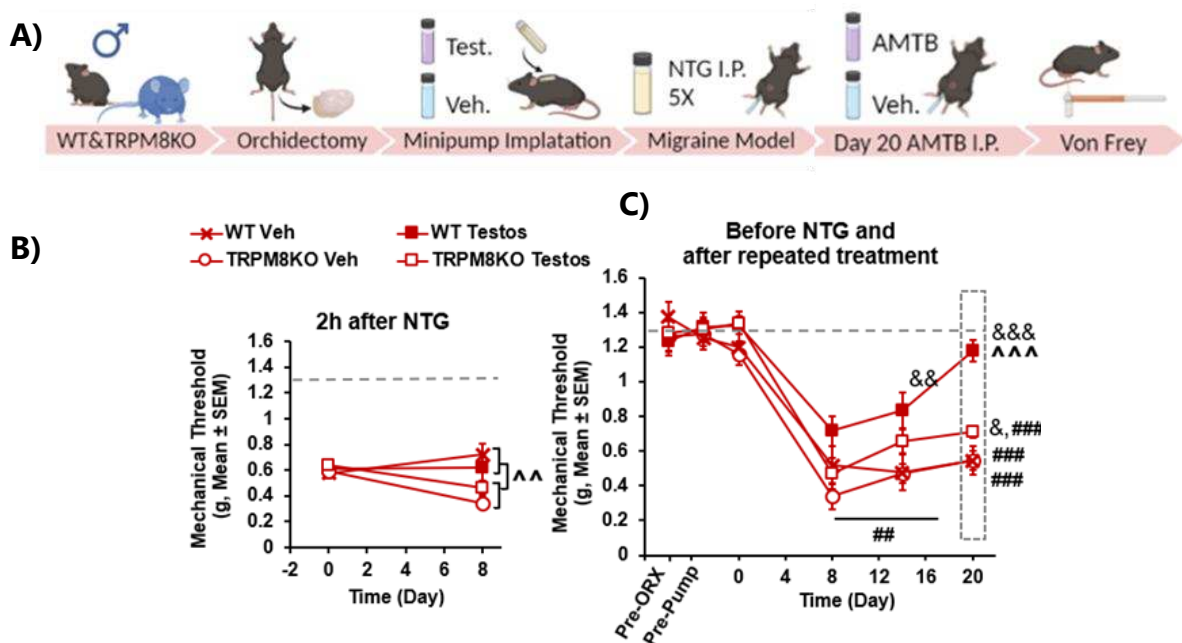

Figure 59 TRPM8 and testosterone inhibit hypersensitivity of male mice chronically treated with nitroglycerin. **A)** Wild-type and TRPM8KO mice were orchidectomized, received minipumps containing testosterone or its vehicle and were subjected to the chronic migraine model. At day 20, mice received a treatment with AMTB at day 20. **B)** Orchidectomized animals receiving testosterone supplementation or its vehicle showed similar acute hypersensitivity after the first dose of nitroglycerin, orchidectomized TRPM8 knockout mice developed stronger sensitization after the last nitroglycerin dose, regardless of the hormonal treatment. **C)** Only wild-type mice receiving testosterone supplementation showed inhibition of the long-lasting hypersensitivity induced after chronic nitroglycerin treatment, and recovered normal sensitivity. TRPM8 deletion or lack of testosterone supplementation did not allow recovery of normal mechanosensitivity values. (*Continued in next page*)

D)

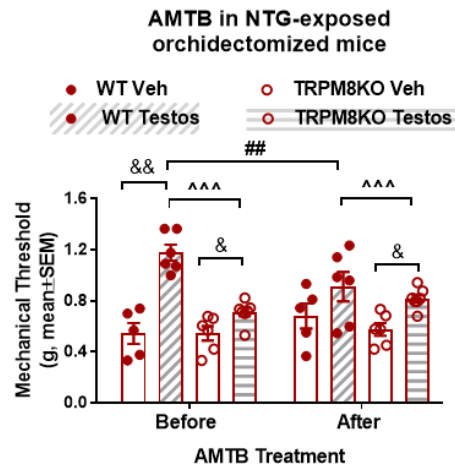
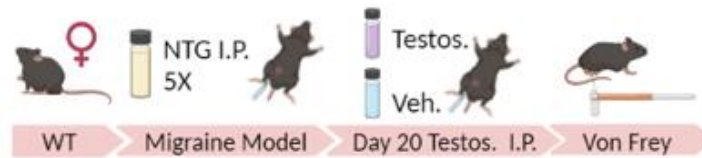

Figure 60 TRPM8 and testosterone inhibit hypersensitivity of male mice chronically treated with nitroglycerin. D) AMTB resensitizes WT animal supplemented with testosterone.

Testosterone-supplemented wild-type mice that recovered their normal sensitivity reinstated their pain sensitization after administration of TRPM8 blocker AMTB on day 21. This response is absent in control and TRPM8 knockout mice. *Mean mechanical threshold ± S.E.M. (B) $^{**}p < 0.01$, $^{***}p < 0.001$ vs TRPM8 KO; $^{\&}p < 0.05$, $^{\&\&}p < 0.01$ vs testosterone vehicle; $^{##}p < 0.01$, $^{###}p < 0.001$ vs. Baseline, 3-way RM ANOVA $n=6$. (C) $^{***}p < 0.001$ vs TRPM8 ko; $^{\&}p < 0.05$, vs testosterone vehicle; $^{##}p < 0.01$ vs. basal, 3-way RM ANOVA $n=6$.*

Next, to determine if testosterone could also present a rapid antinociceptive effect in females, we treated nitroglycerin-exposed wild-type and TRPM8 knockout females with a single 1mg/kg testosterone or its vehicle (2.5 DMSO in corn oil) (**Figure 61A**). Testosterone produced a significant recovery of basal values in wild-type females (**Figure 61B**, $p < 0.05$ vs before testosterone treatment). But testosterone did not ameliorate TRPM8 knockout females (**Figure 61B**, $p < 0.001$ vs wild-type mice). The fast antinociceptive effect of testosterone only in wild-type females indicates a non-genomic effect through TRPM8.

A)



B)

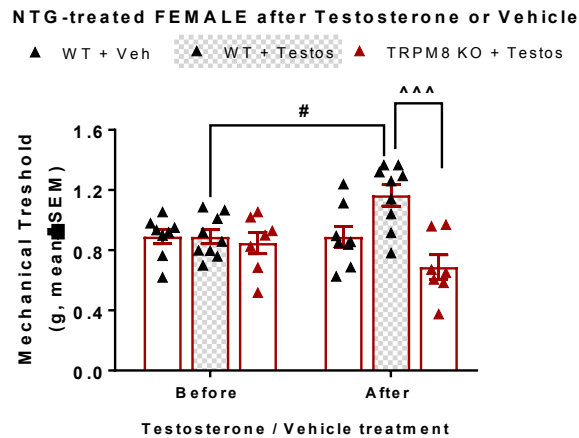

Figure 61 Testosterone produced rapid alleviation of mechanical sensitivity in nitroglycerin treated female wild-type mice, but not in TRPM8 knockout females. A)

Protocol. Wild-type and TRPM8 KO female adult mice were subjected to the chronic migraine model. On day 20, animals were measured for mechanical sensitivity and were injected with 1mg/kg testosterone i.p. and their mechanical threshold was measured again. **B) Testosterone had an antinociceptive effect in females sensitized by chronic nitroglycerin.** Wild-type female mice suffering from persistent hypersensitivity presented rapid recovery of basal sensitivity values 1 h after i.p. testosterone 1 mg/kg, but not TRPM8 KO mice. *Mean mechanical threshold ± S.E.M. ^^^p<0.001 vs *trpm8 ko*, #p<0.05 vs. Basal, 2-way ANOVA n=7-9.*

3. TESTOSTERONE ELICITS TRPM8-MEDIATED CALCIUM TRANSIENTS

We then assessed the interaction between testosterone and TRPM8, as the androgen was suggested to have an agonistic effect over the melastatin channel. For this, we performed primary trigeminal cultures, and studied neuronal activity in calcium imaging when challenged with testosterone (**Figure 62A**). Primary cultures from trigeminal ganglia showed calcium transients in response to testosterone 10pM in the same cells that responded to WS12 500nM (**Figure 62B**, 7.9 ± 0.8 % of KCl-sensitive cells). On the other hand, TRPM8 knockout mice did not present calcium transients when challenged with neither of the stimuli (**Figure 62B**, $P < 0.001$ vs WT).

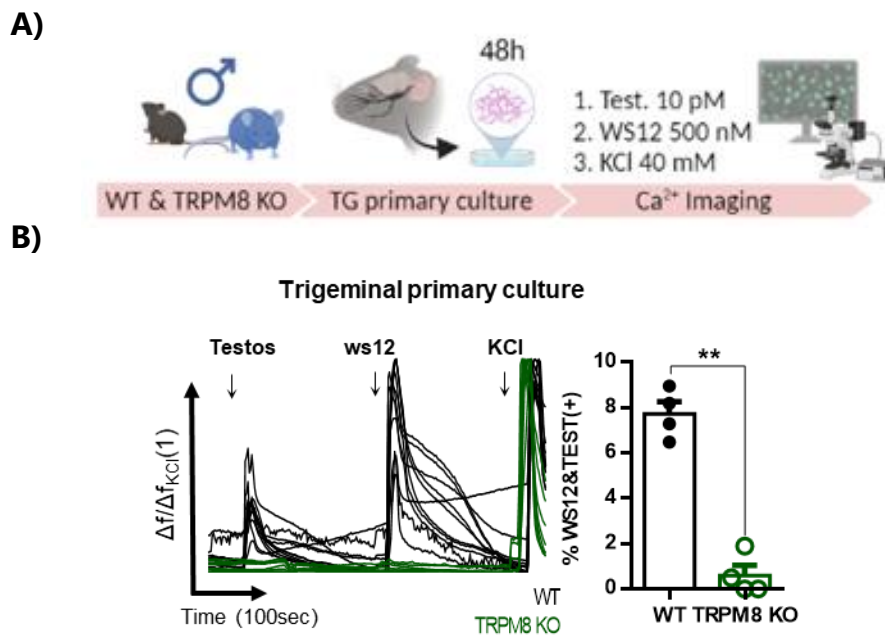

Figure 62 Testosterone presented agonistic activity over TRPM8 receptor. **A) Protocol.** Neuronal cultures of trigeminal ganglia were obtained from adult wild-type male mice. **B) Left panel,** cultured trigeminal neurons showing transient calcium currents after testosterone 10 nM were also sensitive to WS12 (500 nM) and cultured trigeminal neurons of TRPM8 knockout mice were largely unresponsive to both stimuli. **B) Right panel,** 7% of neurons from trigeminal cultures of wild-type mice showed calcium transients in response to testosterone 10 pM, while this response was abolished in TRPM8 knockout. *Mean response size ± S.E.M. (e) *p<0.05 mann whitney u n=4.*

In summary, testosterone plays a protective role in male mice through an interaction with TRPM8. In fact, testosterone application can elicit calcium transients in TRPM8 expressing neurons. Furthermore, testosterone can rapidly alleviate sensitized wild-type females but not TRPM8 knockout females, indicating a rapid non-translational effect of testosterone dependent on TRPM8. These results underline the possibility of a latent sensitization that is masked by tonic TRPM8 activity in males because of their higher testosterone levels.

6. HUMAN VS MOUSE TRANSLATABILITY

Experimental models based on animals find low rates of translatability to humans. To assess the translatability of the previous cellular data, additional experiments were designed to evaluate the activity of human TRPA1 and TRPM8 against the previously studied ligands, i.e. nitroglycerin and testosterone respectively. For the study of human TRPA1, we used human IMR90 cell line that naturally expresses TRPA1 and we used HEK293 LTV cells transfected with murine TRPA1 as a control (**Figure 63A**). Then, we studied calcium transients in response to nitroglycerin (100, 50 and 10 μ M) normalized to ionomycin-induced activation (**Figure 63B**).

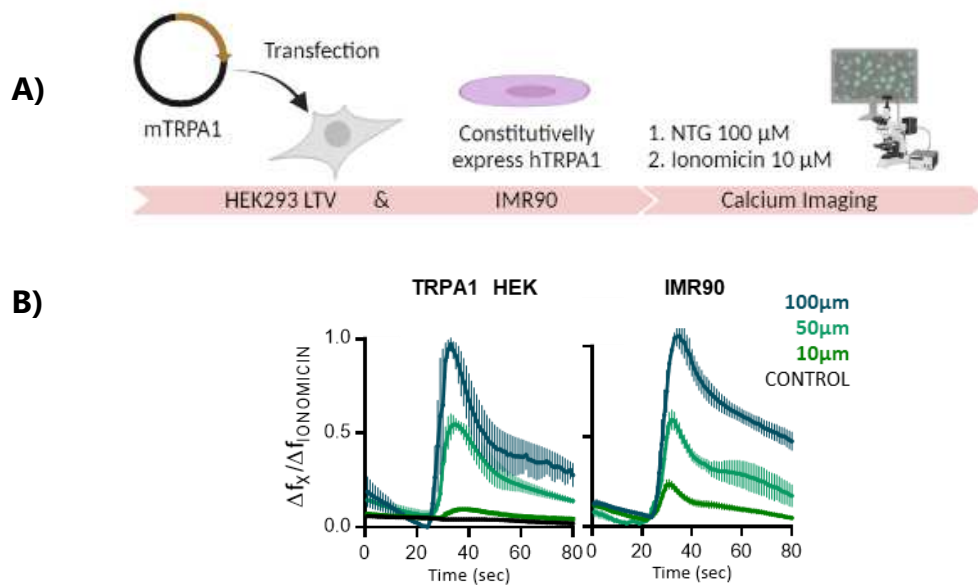

Figure 63 Nitroglycerin produces calcium transients in human and murine TRPA1. A) Protocol. HEK293 LTV cells transfected with murine TRPA1 and IMR90 cells that constitutively express TRPA1 was studied by calcium imaging in response to 3 different nitroglycerin concentrations and normalized to Ionomycin 10 μ M. **B) Nitroglycerin activates human and murine TRPA1 in both species.** Nitroglycerin produced calcium transients of different magnitude according to concentration in TRPA1 channel of both species.

Next, we checked if testosterone could activate human TRPM8 (**Figure 64A**), for this we used HEK293 cells constitutively expressing rat and human TRPM8. As a result, Testosterone produced calcium transients in HEK cells expressing human

and murine TRPM8, but not in naïve HEK cells (**Figure 64B**, $p < 0.001$ vs control HEK293).

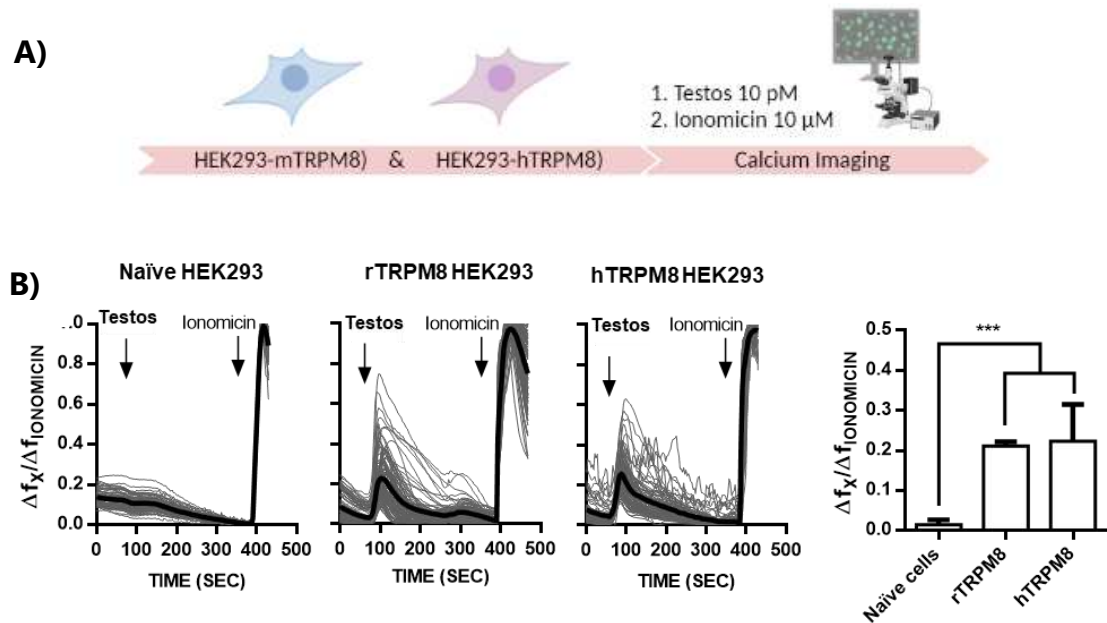

Figure 64. Testosterone elicits calcium transients in HEK293 cells expressing human or murine TRPM8. **A) Protocol** We used HEK293 cells with constitutive expression of human or murine TRPM8 and naïve HEK cells as a negative control. Cells were challenged with testosterone 10 pM and ionomycin 10 μM. **B) Testosterone produced responses in TRPM8 expressing cells from both species.** Testosterone produced calcium transients in HEK cells expressing human and murine TRPM8, but not in naïve HEK cells. Mean response size \pm S.E.M. *** $p < 0.001$ vs control, Mann-Whitney $n > 80$.

In summary, human and murine TRPA1 present calcium responses when challenged with nitroglycerin and TRPM8 from both species showed activity in response to testosterone.

DISCUSSION

*And I will say that
We should take a day to break away
From all the pain our brain has made
-Twenty-one Pilots; Migraine*

DISCUSSION

This project is centered in the study of mechanisms underlying pain chronification that could explain sexual differences in pain sensitization. With this objective in mind, we performed a chronic murine migraine model obtained by 5 nitroglycerin injections described by Pradhan et al 2014. Nitroglycerin injections produce similar acute sensitization in male and female mice, but repeated administration elicits a long lasting hypersensitivity exclusively persistent in females. Nitroglycerine as a nitric oxide donor activates TRPA1 which is responsible for short term sensitization and it produces CGRP release, which is responsible for chronic mechanical hypersensitivity. Then we discovered that TRPM8 plays an anti-hyperalgesic role in male mice, which was testosterone dependent. Meaning that lower levels of androgens in females could explain the persistency of mechanical hypersensitivity. Notably, sexual dimorphism produced by our chronic nitroglycerin model is similar to that observed in humans, where women are more prone to transition into a chronic sensitization⁶⁷ and men present higher resistance to this process²³⁹ in a testosterone dependent manner. In summary, our results show that the exposure to repeated noxious insults like NO-related stimuli recruit TRPA1 receptor and induce CGRP release, leading to the chronification of painful states in both sexes. Male mice present a protective hormone-dependent mechanism involving activation of TRPM8 receptor by testosterone that allows them to recover basal sensitivity.

1. TRPA1

TRPA1 has been described as a sentinel of stress and tissue damage¹⁶⁶, evolutionary studies suggest a primordial role of response to almost any type of chemical and physical damage²⁸, finally, TRPA1 activation leads to the activation of protective mechanisms. The problem arises from excessive activation of the ankyrin receptor, which leads to pain sensitization. Here we discuss its relevance in the chronic migraine model obtained by repeated nitroglycerin injections. *In-vitro* results show that nitroglycerin produces TRPA1 activation. TRPA1 relevance translated into the *in-vivo* experiments, as TRPA1 knockout mice lack acute sensitization in response to nitroglycerin. These mice also did not develop the chronic sensitization produced by repeated nitroglycerin injections. In agreement,

previous studies showed that TRPA1 participated in response to acute nitroglycerin application, and sensitivity elicited by nitroglycerin could be prevented by TRPA1 antagonism and antioxidants²⁵⁰⁻²⁵².

Recurrent nitroglycerin exposition produced similar increase of TRPA1 mRNA expression in both sexes. Increased TRPA1 expression was accompanied by stronger TRPA1 activity in response to AITC in trigeminal cultures from animals exposed to the chronic migraine model. TRPA1 overexpression and gain of function is common in pain alterations that curse with activation of the channel²⁵³. For example, formalin long-lasting pain produces TRPA1 overexpression in dorsal root ganglia and spinal cord²⁵², it is also upregulated in inflammatory^{44,254}, neuropathic²⁵⁵ and even in cancer pain models¹⁷². TRPA1 can be activated by a diversity of stress and damage signals^{166,256}, and its activation leads to neurogenic inflammation and more production of the aforementioned TRPA1 noxious stimuli. This positive loop of nociceptive signalling appoints TRPA1 as a gatekeeper of sensitization and pain^{161,215} (**Figure 20**). Thus, TRPA1 could be a candidate underlying migraineurs hyper-excitabile trigeminovascular system, which can elicit migraine paroxysms in response low threshold stimuli, like umbelolone or cigarette smoke¹⁹³. TRPA1 gain of function could also be associated to activation of silent nociceptors^{257,258}, which gain mechanosensitivity upon sensitization¹⁶, and TRPA1 is a known trigger of mechanosensitivity. This could explain why migrainerus, especially those with high frequency of attacks, suffer from a throbbing sensation in the head and mechanical allodynia even between migraine attacks⁶⁷. When sensitized, TRPA1 expressing nociceptors also present gain of function in voltage-gated sodium channels²⁵⁹⁻²⁶² and a decrease of potassium channels²⁶³, increasing excitability of nociceptors.

TPRA1 was originally described as a cold sensor⁵⁹, recent studies show molecular capability to respond to both heat and cold¹⁷⁶. In-vivo experiments presented

controversial results upon the role of TRPA1 response to cold in basal conditions, although its relevance in cold hypersensitivity in pain conditions is more clear¹⁸². Furthermore, TRPA1 is needed for noxious temperature perception in mice¹⁰². Given all this evidence, high or low temperatures could activate the sensitized TRPA1 in migraine and contribute to nociception. However, a study in migraine patients did not find a relation between heat or cold with the origin of migraine attacks²⁶⁴. Furthermore, cold hats (devices that hold ice against the head, neck and face) have proven useful in preventing and alleviating migraine pain²²². In fact, cold and heat application have shown effectiveness in treating pain in migraine²⁶⁵. To conclude, TRPA1 is the convergence point of many sensitization mechanisms which encompass sustain of chronic pain, thus TRPA1 could be a pharmacological target⁵⁸ for pain treatment. Although, its role in response to stress and damage²⁶⁶ could produce undesirable secondary effects.

2. TRPV1

TRPV1 channel is the canonical pain TRP, and it has been linked to trigeminal sensitization and migraine^{211,267}, as happens with TRPA1, it is a transducer capable of stimulating CGRP release²⁵. But, pharmacological ablation of the TRPV1 receptor with resiniferatoxin (data not shown in this thesis) did not prevent development of the migraine model, indicating that it is not essential for the nitric oxide-dependent sensitization mechanism. Nevertheless, it was interesting to check a possible implication of the vanilloid receptor in this model. Cultures of trigeminal ganglia from mice treated with nitroglycerin did not present increase TRPV1 activity. TRPV1 and TRPA1 co-express in nociceptors and can influence each others activity; activation of TRPA1 produces a local increase of intracellular calcium, which can sensitise TRPV1⁴⁷. For this reason, we explored the possibility that nitroglycerin activation of TRPA1 produced TRPV1 potentiation^{268,269}. In our experiments, TRPV1 activation by capsaicin was not potentiated by nitroglycerin-mediated TRPA1 activation. Finally, it has been described that ATP and bradykinin

receptors can be overexpressed during pain sensitization²¹⁶ and activation of their receptors produce TRPV1 recruitment to the membrane by exocytosis of Large Dense Core Vesicles producing TRPV1 potentiation²⁵. Still, potentiation of capsaicin response by ATP and bradykinin was not increased in cultures from male or female animals treated with nitroglycerin. A possible limitation of our migraine model is that it recruits directly TRPA1 for pain signalling and sensitization, thus other relevant molecular entities like TRPV1 can be overstepped.

3. CGRP

CGRP could be considered the cornerstone of migraine, it participates in its onset and together with TRPA1 forms a closed network of mediators that feeds neurogenic inflammation in the trigeminovascular system²¹⁶. We could demonstrate that TRPA1 activation by nitroglycerin promotes CGRP release from trigeminal neurons in culture. Accordingly, CGRP knockout prevented chronic sensitization of the animals treated with nitroglycerin. Furthermore, CGRP release from cultured trigeminal neurons is prevented with the exocytosis inhibitor DD04107, which inhibits Large Dense Core Vesicles fusion with cellular membrane by interacting with SNAP-25²⁷⁰. Indeed, intraperitoneal injection of DD04107 at experimental day 10 of the migraine model precipitated a fast recovery both in male and female animals. Thus, TRPA1 has a priming function in the trigemnovascular system initiating CGRP release, the resulting sensitization requires CGRP signalling to persist after the end of introduction of exogenous nitric oxide. The relevance of CGRP in sensitization can be explained by the distribution of its receptors, and the consequences of its activation. Our results are in line with the critical role of this neuropeptide in the pathophysiology of chronic migraine²⁷¹.

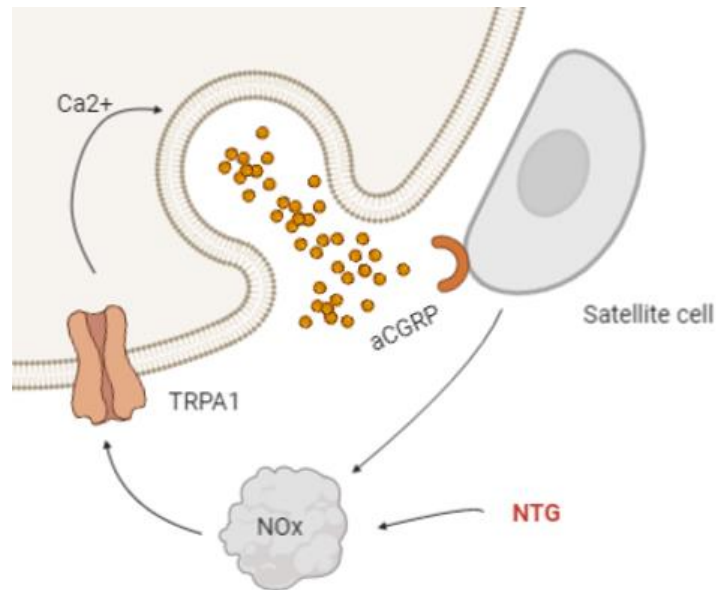

Diverse antibodies designed to interfere with CGRP signalling have been approved by the FDA for migraine treatment²¹⁰. Another drug that interferes with CGRP signaling is the botulinum toxin, that blocks CGRP release. It successfully alleviates migraine in preclinical models of migraine²⁷², and it has even been successful with migraine patients²⁷³. Furthermore, botulinum toxin has also shown anti-itch effect in a model produced by chloroquine, which is CGRP dependent. In this line, the exocytosis inhibitor DD04107 presents potential against CGRP dependent pain alterations, like migraine.

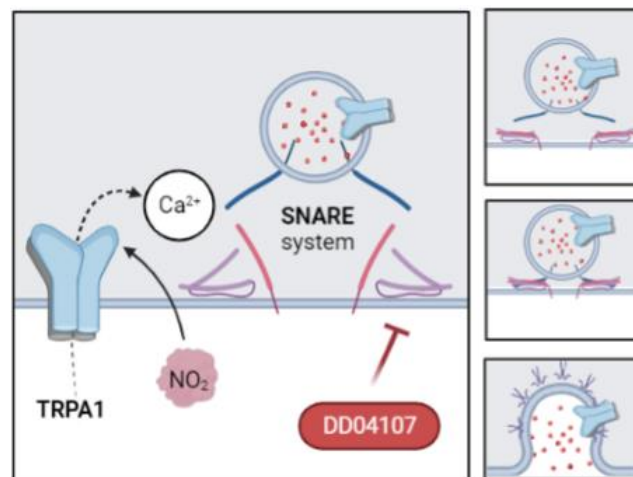

Figure 65 DD04107 inhibits Large Dense Core Vesicles (LDCV) fusion with cellular membrane. This peptide interferes with SNAP25 of the SNARE complex, inhibiting the correct alignment of the machinery for LDCV regulated exocytosis. This prevents CGRP release and recruitment of TRPV1/TRPA1 to the membrane of peptidergic C nociceptors, decreasing neuroinflammation and nociceptor sensitization.

4. TRPM8

Regarding TRPM8, the results obtained in TRPM8 knock out animals treated with repeated nitroglycerin injections showed a potential antinociceptive function of the melastatin receptor, since TRPM8 knockout males developed persistent mechanical sensitivity like wildtype females. Accordingly, TRPM8 stimulation has proven efficacy alleviating nocifensive behaviours in headache-type pain models^{219,274}. This anti-nociceptive role is also present in pain models produced by extreme temperatures or substances like the TRPV1 agonist capsaicin or the TRPA1 agonist acrolein^{162,163,185,275}. Activation of TRPM8 has also been proven effective against mechanical and heat sensitivity produced by neuropathic pain^{276,277}. Indeed, TRPM8 agonists have been used medicinally for alleviating diverse pain alterations, including migraine^{220,221,278,279}, although never as a first-choice treatment²⁸⁰. In contrast, TRPM8 antagonists produced analgesia particularly in neuropathic pain models obtained by chronic constriction injury and oxaliplatin, which are characterised by cold hypersensitivity²⁸¹. In these cases, patients experience pain sensations in response to non-noxious cooling at temperatures in the range of TRPM8 activation approximately from 27 to 16°C. TRPM8 agonists have also presented proalgesic activity in migraine²¹⁷, although these results could be a consequence of the use of TRPM8 agonists with partial effect over TRPA1 such as icilin²⁸² or menthol¹⁷⁹. There are studies developing new TRPM8 antagonists for the treatment of migraine^{281,283}, although these studies are based on modifications of TRPM8 blocker AMG333 which was used in a clinical trial that started in 2013 (NCT01953341) with no significant effects in migraine pain relief.

We ratified the anti-nociceptive role of TRPM8 by the application of TRPM8 antagonist AMTB, that produced a rapid re-sensitization in males that had already recovered after nitroglycerin injections, indicating the existence of a basal activity of TRPM8 opposing pain sensation. In relation to all of this, it has been recently

described that TRPM8 cold sensing neurons are needed for warmth sensation; these neurons present a basal activity that is silenced by warm temperatures¹⁰². Thus, they have discovered that warm perception arises from the integration of distinct sensory inputs; increased activity of warm sensing neurons expressing TRPV1 and TRM3 and decreased activity of TRPM8. TRPM8 has been described to prevent irritation produced by TRPA1 agonists (cigarette smoke and nicotine^{284–286}) in the respiratory system. It has been proposed that activation of TRPM8 expressing fibres produces a silencing of C nociceptors expressing TRPA1²⁸⁷. Activation of TRPM8 pathways could inhibit TRPA1 transmission in two main ways: 1. Glutamatergic activation of inhibitory interneurons in the second lamina of the dorsal horn, which modulate the activity of projection neurons from the lamina I in the TRPA1 pathway^{190,217,219,274,287}. It has also been described that nociceptor inhibition by TRPM8 activation is dependent on inhibitor metabotropic glutamatergic receptors II & III (mGluRs), which are expressed in the presynaptic cleft of nociceptors¹⁹⁰.

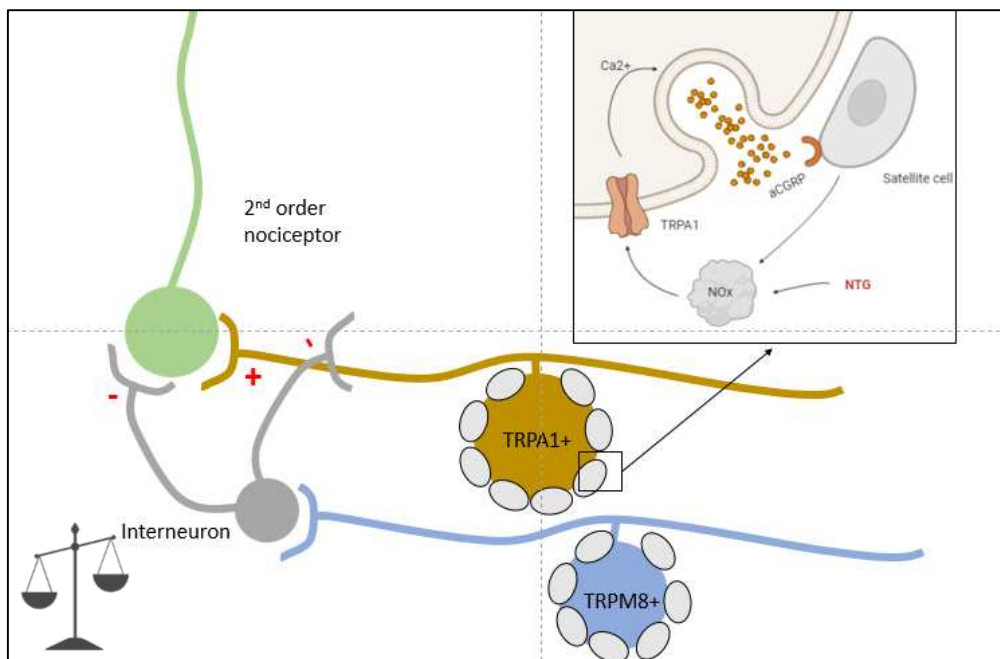

Figure 66 Activation of TRPM8 pathways inhibit TRPA1 expressing nociceptor transmission hypothesis. TRPM8 expressing neurons apply inhibitory over TRPA1 pathways via inhibitory interneurons, and could even inhibit the C nociceptor soma and terminal through backpropagation of hyperpolarization^{190,217,219,274,287}.

In order to confirm the obtained results in the nitroglycerin model of chronic migraine, we used another TRPA1-dependent pain model; formalin injection in the paw produces TRPA1 dependent pain¹⁷³. Intraplantar formalin injection produces a particular pattern of nocifensive behaviour; the first 10 minutes are characterised by a nociceptive response that is caused by direct activation of TRPA1 in nociceptors. Then, the activity recedes until approximately 20 minutes after injection, when nocifensive behaviour starts again in response to the inflammation produced CGRP liberation²⁸⁸. Thus, we wanted to corroborate in this model if TRPM8 also masks the latter pain sensitisation in the formalin pain model. Male mice that had already stopped expressing nocifensive behaviour re-started this phenotype after AMTB application. Our results pointed to a possible latent sensitization 60 minutes after formalin application that is masked by a tonic activity of TRPM8 channel. Female mice that were injected with WS12 and formalin presented less nociceptive response in the first 10 minutes. These results highlight the protective effect that TRPM8 presents in males. Interestingly TRPM8 activation by WS12 in females only produced a short-lived alleviation of pain, this could be due to a strong activation and desensitization of the melastatin channel, or to pharmacodynamics of the substance. Similar results have been described in an acrolein plantar test, which also depends on TRPA1 and produces similar behavioural responses. TRPM8 agonists menthol and WS12 produced pain alleviation that was opioid dependent²⁸⁹. Furthermore, TRPM8 agonists have proven antiinflammatory²⁸⁴⁻²⁸⁶ and antinociceptive^{289,290} effects dependent of opioid activity. Thus, TRPM8 agonists could be used for pain relief in diverse pain alterations.

5. TESTOSTERONE

TRPM8 anti-hyperalgesic effect was only present in male mice, suggesting the existence of an endogenous TRPM8 agonist present in males and not in females, which regulates sexual dimorphism of the pain model. Testosterone hormone has been proposed as a TRPM8 agonist^{188,291}. We could show that primary cultures

from trigeminal ganglia presented calcium transients when challenged with testosterone at picomolar concentration. Interestingly, these calcium responses could not be obtained in TRPM8 KO mice, this event had been previously described in different cell lines exogenously expressing TRPM8 and in planar membranes²⁹². Indeed, activity of TRPM8 elicited by testosterone had been proven in primary DRG neurons through TRPM8 antagonism¹⁸⁷. An *in-silico* model of human and murine TRPM8 made in our laboratory (based on the known structure of a bird TRPM8¹⁵²) has shown that menthol and WS12 binding pocket³²³ could potentially be targeted by testosterone **Figure 67**. This computational model, also predicts that estradiol and progesterone can interact with the menthol binding pocket with lesser potency than testosterone, this could explain the results obtained by Mohandass et al. 2020, where they saw that progesterone and estradiol could produce TRPM8-dependent currents¹⁸⁸. Finally, the warm temperature receptor TRPM3 has also been described as a detector of sexual hormones like pregnenolone and progesterone²⁹⁴, highlighting the relevance of these proteins as detectors of endogenous stimuli.

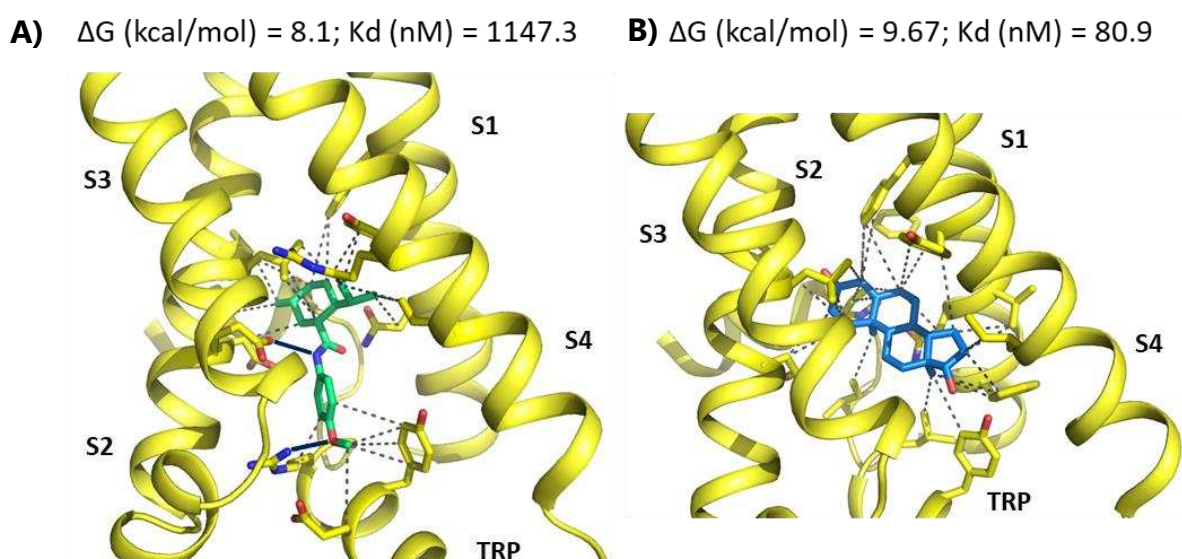

Figure 67 Binding of the menthol derivative WS12 and testosterone to the human TRPM8 menthol pocket after local docking simulations. A) WS12 B) Testosterone. The TRPM8 structure is shown as yellow cartoon representing with sticks the side chains involved in the binding. WS12 and testosterone are shown as sticks of different color. Gray-dashed lines indicate Van der Waals interactions with ligands, whereas blue-solid lines are hydrogen bonds. Hydrogen atoms have been removed. S1, S2, S3, S4 and TRP are TRPM8 transmembrane domains. ΔG is an estimation of the binding energy. Kd is the dissociation constant calculated with ΔG using the equation $\Delta G=R \cdot T \cdot \ln Kd$.

In our nitroglycerin migraine model, sensitized females injected with testosterone developed a rapid antinociception that was TRPM8 dependent, as TRPM8 knockout females did not respond to the testosterone treatment. In addition, male orchidectomized mice presented a long-lasting hypersensitivity in response to nitroglycerin, similar to females. It has been described that orchidectomized males have difficulty to recover normal sensitivity after stress or inflammatory-related lesions^{295–297}. These studies also reported antinociceptive role of testosterone through signalling over the androgen receptor²⁹⁶, decreased expression of anti-opioid neurotransmitter BDNF (brain derived neurotrophic factor)²⁹⁷ or involvement of serotonin transporters²⁹⁵. We found that orchidectomized wild-type mice supplemented with testosterone behaved like control animals, and the testosterone-driven recovery needed of TRPM8 expression. Thus, we propose a role of TRPM8 as a receptor of the endogenous testosterone that produces antinociceptive effect and provides pain resilience.

Other alterations affecting only males have been described for TRPM8 knockout mice, were the knockout males present similar characteristics as females, with lower bone density and slower acclimation to cold²⁹⁸, while TRPM8 knockout females showed the same bone density and thermoregulatory responses as wild-type females. The differential role of TRPM8 between sexes has been recently linked to the activity of sexual steroids²⁹⁹. In our results, testosterone had a fast antinociceptive effect in females treated with nitroglycerin, similar to the anxiolytic effect described for this androgen³⁰⁰. Furthermore, testosterone has proven efficacy in preclinical studies of chronic and acute pain^{295–297}. In agreement, testosterone has successfully been used with antinociceptive effects in clinical trials⁹³, and men and women with lower levels of the androgen tend to be more sensitive to pain alterations^{94,246}, including migraine²³⁹. Androgens can be used as pain treatment⁹³, but hormonal therapies might present strong secondary effects that hamper their use³⁰¹.

The opioid system has also shown connections with testosterone signalling. For instance, opioid signalling reduces testosterone production, as shown by the fact that overuse of opioid drugs such as methadone produces hypogonadism in men³⁰². Curiously, chronic migraine in men is also associated with hypogonadism²³⁹. Furthermore, central opioid system recruitment by mu-opioid agonists is stronger in males and this difference depends on testosterone signalling¹³⁷. Indeed testosterone regulates the expression of opioid receptor subtypes¹⁴⁶ and modulates opioid receptor activity. TRPM8-testosterone interaction regulate sexual behaviour (mounting frequency) and satiety in mice by its interaction with amygdala and ventral tegmental area¹⁸⁸. It could be possible that descending pathways from amygdala regulated by TRPM8-testosterone interaction explained part of the differential recruitment of opioid system in the periaqueductal gray, thus modulating analgesic³⁰³ and anti-inflammatory effects³⁰⁴ mediated by this system.

6. TRANSLATABILITY OF OUR RESULTS AND PHARMACOLOGICAL APPLICATIONS

Given the sequence differences between the TRPA1 and TRPM8 genes of human and murine species, it was important to determine whether the results obtained in the animal models could also be reproduced in human receptors. We observed that murine TRPA1 transfected in HEK cells and IMR90 natively expressing human TRPA1 presented calcium transient in response to nitroglycerin in a dose-response manner. TRPM8 activation by testosterone was also confirmed for the human receptor, increasing the translatability of our results for its potential use as a druggable target for migraine treatment. Hence, unravelling interaction between testosterone and TRPM8 could be helpful for the design of new molecules that mimic the agonistic activity of testosterone but avoiding the secondary effects of hormonal treatments. Mutagenesis studies will be needed to ratify the potential sites of interaction.

Overall, we found druggable targets with therapeutic potential against chronic migraine; targeting TRPA1 signalling could serve to stop the onset of migraine, that can be elicited by endogenous and exogenous triggers, and sustained activation of TRPM8 could constitute a viable mechanism for recurrent migraine, as it has proven rapid and long-lasting anti-hyperalgesic effects. TRPM8 agonists have already been approved for medical and culinary use, which renders them as an interesting approach. Targeting the peripheral nervous system may be an effective strategy to prevent pain sensitization and it presents some advantages from other types of treatment^{305,306}, such as the local administration that can avoid systemic effects. In this line, TRPM8 agonists like menthol have shown topical analgesic properties³⁰⁷, and TRPM8 agonist applied in the face produced analgesia in a preclinical model of migraine²¹⁹.

7. SUMMARY

In conclusion, a chronic migraine model produced by repeated nitroglycerin injections produces cutaneous hypersensitivity which is associated with chronic migraine in humans²⁴⁴, a type of sensitization that can be elicited by internal and environmental factors involving TRPA1 activation, like inflammation, oxidative stress and pungent substances²¹⁵. In our model, TRPA1 serves as a nitric oxide sensor that produces CGRP release from nociceptors, for this reasons both are necessary mediators for the instauration of the model. This model presented a sexual dimorphism characterized by a longer lasting sensitization on females, explained by a stronger of male individuals. This effect was associated to TRPM8 stimulation by the androgen testosterone, which presents higher levels in males. TRPM8 anti-hyperalgesic effect is then presented as a physiological restorative mechanism exclusively present in males, encouraging further research on the mechanisms underlying pain resilience. Additionally, results from this work have shown interesting druggable targets that could be further explored in preclinical models of pain. In first place, TRPA1 antagonism could be an interesting analgesic

target, although its neuroprotective role as a hypoxia sensor call for careful modulation. CGRP release inhibition also shows promising effects in migraine and other pain alterations dependent on neurogenic inflammation. Finally, development of TRPM8 agonists mimicking testosterone but lacking secondary effects of hormonal treatments could provide pain relief for individuals with low testosterone.

CONCLUSIONS

*Am I the only one I know?
Waging my wars behind my face and above my throat
Shadows will scream that I'm alone
But I know we've made it this far, kid
-Twenty-one Pilots; Migraine*

CONCLUSIONS

1. Nitroglycerin administration produces rapid mechanical sensitization in male and female mice. Repeated injections produce a long lasting mechanical sensitization that is persistent only in female mice.
2. Nitroglycerin activates TRPA1 which is necessary to inflict acute and chronic mechanical hypersensitivity in male and female mice treated with repeated injections of nitroglycerin.
3. Nitroglycerin migraine model produces overexpression of trigeminal TRPA1, which translates into an increase of TRPA1 activity in trigeminal cultures from treated animals.
4. Nitroglycerin is a stimulus capable of CGRP exocytosis, which could be blocked by exocytosis inhibitor DD04107.
5. TRPV1 activity is not increased in trigeminal neurons of animals exposed to the nitroglycerin model and it doesn't increase TRPV1 potentiation by ATP or bradikinin. Nitroglycerin does not potentiate TRPV1 activity when applied in culture.
6. TRPM8 plays a protective role in male mice exposed to the chronic migraine model. Blockage of TRPM8 produces a rapid resensitization of already recovered animals.
7. TRPM8 plays a protective role in male mice exposed to the intraplantar formalin model, and exogenous administration of TRPM8 agonist WS12 produced nociceptive alleviation in females.
8. Testosterone application can elicit calcium transients in TRPM8 expressing neurons. Testosterone plays a protective role in male mice through an interaction with TRPM8. Testosterone can rapidly reverse sensitized wild-type females but not TRPM8 knockout, indicating a rapid effect dependent on TRPM8.
9. Testosterone can activate human TRM8 and nitroglycerin can activate TRPA1, showing that our results can be translated into human.

Conclusiones

1. La administración de nitroglicerina produce una sensibilización mecánica rápida en ratones machos y hembras. La inyección repetida produce una sensibilización mecánica duradera que es persistente solo en hembras.
2. La nitroglicerina activa TRPA1 el cual es necesario para el desarrollo de la hipersensibilidad mecánica en ratones machos y hembras tratados con inyecciones repetidas de nitroglicerina.
3. El modelo de migraña inducido por nitroglicerina produce sobreexpresión de TRPA1 en el trigémino, lo cual va acompañado de un incremento de la actividad de TRPA1 en cultivos de trigémino de animales tratados.
4. Nitroglicerina es un estímulo capaz de producir exocitosis de CGRP, la cual puede ser bloqueada con el inhibidor DD04107.
5. La actividad de TRPV1 no se ve aumentada en el trigémino de animales expuestos a nitroglicerina y tampoco se ve aumentada su potenciación por ATP o bradiquinina. La nitroglicerina no potencia la actividad de TRPV1 cuando es aplicada en cultivo.
6. TRPM8 juega un papel protector en ratones macho expuestos al modelo de nitroglicerina. El bloqueo de TRPM8 produce una re-sensibilización rápida de animales ya recuperados.
7. TRPM8 juega un papel protector en ratones machos expuestos al modelo intraplantar de formalina y la administración del agonista de TRPM8 WS12 produce alivio del dolor en hembras.
8. La administración de testosterona puede producir respuestas de calcio en neuronas que expresan TRPM8.
9. La testosterona juega un papel protector en machos dependiente de la presencia de TRPM8. La testosterona puede revertir rápidamente hembras silvestres sensibilizadas pero no en knockout para TRPM8, indicando un efecto rápido de TRPM8.
10. La testosterona puede activar TRPM8 humano y la nitroglicerina puede activar el TRPA1 humano, indicando que nuestros resultados pueden ser transferibles a humanos.

MATERIALS AND METHODS

1. ANIMALS

Experiments were performed on adult male and female mice of different mouse strains with a common C57BL/6J background were, including wild-type mice (C57BL/6JRccHSd) and knockouts for Calca (CGRP KO), Trpa1 (TRPA1 KO) and Trpm8 (TRPM8 KO) genes. C57BL/6JRccHSd mice were originally obtained from Harlan Laboratories and bred in the animal facility at University Miguel Hernández de Elche (Elche, Alicante, Spain). TRPM8 knock out mice were originally designed in the laboratory of Dr. David Julius¹⁸⁴ and were a gift from Dr. Félix Viana. TRPA1-deficient mice were supplied by Dr. David Corey¹⁷⁴. α CGRP knock out mice (B6;129-Calcatm) were kindly donated by Dr. J.P. Changeaux. All procedures were approved by the Institutional Animal and Ethical Committee of the University Miguel Hernández de Elche, in accordance with the guidelines of the Economic European Community and the Committee for Research and Ethical Issues of the International Association for the Study of Pain.

1. DRUGS FOR BEHAVIOURAL STUDIES

Two nitroglycerin formulations were used: 5 mg/1.5 ml ampoules and 50 mg/50 ml vials (Bioindustria LIM, Novi Ligure, Italy). The ampoules contained nitroglycerin dissolved on a vehicle made of 1 ml propylene glycol and 0.5 ml ethanol (Bioindustria LIM). This initial solution was dissolved in saline to obtain 1 mg/ml nitroglycerin, reaching final concentrations of 10% ethanol and 20% propylene glycol. The 50 mg/50 ml nitroglycerin vials contained a vehicle made of 5% dextrose and 0.105% propylene glycol in pure water (Bioindustria LIM). This nitroglycerin or its vehicle was administered without further dilution. The TRPM8 selective blocker AMTB hydrochloride (AMTB, N-(3-aminopropyl)-2-[(3-methylphenyl) methyl] oxy}-N-(2-thienylmethyl) benzamide hydrochloride, Tocris, Bristol, UK) was dissolved in dimethyl sulfoxide (DMSO, Merck, Darmstadt, Germany) and was further diluted in saline to reach 2.5% DMSO. The potent and

selective TRPM8 agonist WS12 ((1R,2S,5R)-2-Isopropyl-N-(4-methoxyphenyl)-5-methylcyclohexanecarboxamide, Tocris) was dissolved in DMSO and diluted in corn oil to reach 2.5% DMSO. In a previous preparation, WS12 was dissolved in ethanol and diluted in 45% 2-Hydroxypropyl- β -cyclodextrin in water to reach 5% ethanol, although precipitation was found at these concentrations. All these compounds and vehicles were injected intraperitoneally at a volume of 10 ml/kg. In the formalin test, WS-12 was dissolved in DMSO and diluted in saline up to 0.6% DMSO to achieve an amount of 6 nmol in 20 μ l as previously described²⁸. We used WS12 and not menthol or icilin as a TRPM8 agonist to avoid unspecific signaling over TRPA129. Testosterone (T1500, Merck) was dissolved in 45% 2-Hydroxypropyl- β -cyclodextrin in water to obtain a solution of 22 mg/ml.

2. GENOTYPING

Genotyping for the identification of knockout mice was performed on genomic DNA obtained from the tail tip of mice. For the DNA extraction we used the Sodium Hydroxide protocol as described elsewhere³⁰⁸. In brief, mouse tail tissue was incubated with 75 μ L of basic solution (25mM NaOH and 0.2 mM EDTA) for 1 h at 98 °C and then 75 μ L of acid solution (40 mM Tris-HCl, pH 5.5). Then, samples were centrifuged at 1500 g for 3 min. The resulting pellet was air-dried and dissolved in water. 2-4 μ l of the extract were used for PCR amplification. PCR was performed with Promega enzyme GoTaq G2, although the protocol was adapted for a 25 μ L reaction. Each reaction was adjusted to a final concentration of MgCl₂ 2 mM, dNTP 0.2 mM, primers 0.5 μ M (**Table 5**) and 2 μ L of cDNA.

Table 5. Primers used to genotype the different knockout mice

	Forward/ Reverse
TRPM8KO	AGGCCTGCCGATTCACACAGC/ GCTCGCCCCCAAGGCTG
TRPA1KO	ATCAAACCTATATACATAATCA/ ACAGATCACATACAGTCG
CGRPKO	TACAACAAGTATACGACAAC/ CCGCGGGCTATATAGGCCT

CHRONIC MIGRAINE MODEL INDUCED BY NITROGLYCERIN

The chronic migraine model is based on a work from Pradhan A.A. et al and consists of the repeated administration of nitroglycerin^{242,309}. This model is based on the migraine attacks induced after nitroglycerin treatments in humans^{226,243,310,311}. In this work, we used nitroglycerin (Bioindustria L.I.M., Italy) dissolved in two different formulations of vehicle, the first one contained 10% ethanol and 20% propylene glycol in saline solution, the second vehicle contained 5% dextrose and 0.105% propylene glycol in water. Nitroglycerin was injected i.p. at a final dose of 10mg/kg (1mg/ml) each other day for 9 consecutive days, for a total of 5 injections. Control animals were treated with the excipients of the drug described previously. Animals treated with nitroglycerin showed acute and chronic mechanical sensitization that could be measured with von Frey filaments.

3. ASSESSMENT OF MECHANICAL SENSITIVITY

Mechanical sensitivity was quantified by measuring the hind paw withdrawal response to von Frey filament stimulation, following the "Up and Down" method³¹². Briefly, animals were placed in Plexiglas® chambers (10 x 13 x 17 cm) with a wire grid bottom (hole aperture 6x6 mm) through which the von Frey filaments (bending force range from 0.008 to 2 g) (North Coast Medical, Inc., San Jose CA, USA) were applied as previously described³¹². The filament of 0.4 g was first applied. Then, the strength of the next filament was decreased when animal responded or increased when animal did not respond. 2 g and 0.02 g filaments were the cut-offs, and the response to these filaments was considered positive (2 g) or negative (0.02 g) regardless of the actual response. This up-down procedure was stopped 4 measures after the first change in animal responding (i.e. from response to no response or from no response to response). The threshold of response was then calculated by using the up-down excel program generously provided by the laboratory of Dr A. Basbaum (UCSF, San Francisco, USA). Prior to baseline measurements, mice were habituated for 4 hours to the testing

environment during 2 days. On the evaluation days, animals were allowed to habituate for 1-2 hours before testing in order to obtain appropriate behavioural immobility. Both ipsilateral and contralateral hind paws were alternatively tested whenever possible and the average of both responses was calculated for each mouse. Stimuli were applied at a minimum of 2 min intervals to avoid hypervigilance or sensitization between successive filament applications. Filaments were completely bent before considering responses and hold up to 4-5 s to consider a negative response. Clear paw withdrawal, shaking or licking were considered as nociceptive-like responses.

Table 5 Filaments used in the allodynia test:

	(-) Cut-off			Initial filament			(+) Control
Grams	2.44	2.83	3.22	3.61	6.84	4.08	4.31
Newtons	0.02	0.07	0.16	0.4	0.6	1	2

4. FORMALIN TEST

We studied chemically-induced nocifensive behaviour through the injection of 20 µl 5% formalin (F8775, Merck) into the paw of the mice. Animals were placed individually in transparent plastic chambers 1 h prior the experiment for habituation. Then, we performed 20 µl subcutaneous injections in the plantar aspect of the right hind paw. Injections were performed with a Hamilton syringe (Hamilton Syringe Gastight™ series 1700, TLL end, Merck) attached to a 30-gauge needle. Observational measurements of behaviour were performed by measuring the time licking or biting the treated paw in intervals of 5 min during 1 or 2 h depending on the experiments. Experiments assessing the effect of TRPM8 activation in females were performed injecting 20 µl of a 45% 2-Hydroxypropyl-β-cyclodextrin solution containing 5% formalin (F8775, Merck) and 0.6% DMSO (Merck) with or without 6 nmol of WS-12 ((1R,2S,5R)-2-Isopropyl-N-(4-

methoxyphenyl)-5-methylcyclohexanecarboxamide, Tocris). Experiments assessing the effect of TRPM8 blockage in males were performed injecting AMTB 10mg/kg (AMTB, N-(3-aminopropyl)-2-[[3-methylphenyl] methyl] oxy)-N-(2-thienylmethyl) benzamide hydrochloride, Tocris) i.p. or its vehicle DMSO 0.6 % in saline 1 hour after the injection of formalin, in this case nocifensive behaviour was assessed for 2 hours after formalin injection.

5. ORHIDECTOMY

Orchidectomy was performed as previously described with some modifications³¹³. Briefly, male mice were anesthetized with an intraperitoneal injection of ketamine (75 mg/kg; Imalgene, 100 mg/ml, Boehringer Ingelheim, Ingelheim/Rhein, Germany) and xylazine (15 mg/kg, Merck). Once the absence of response to hind paw clamping was evidenced, the scrotum was incised through the midline. Testes were exposed, and vas deferens and testicular blood vessels were ligated with two knots of 6-0 black silk (8065195601, Alcon Cusi S.A., Barcelona, Spain). After dissecting between the two knots, testes and epididymis were removed and the scrotal incision closed with three square knots. To simulate the operation in sham animals, testicles were exposed but not ligated or removed. All animals were allowed to recover for 3 weeks before the continuation of the experiments.

6. TESTOSTERONE REPLACEMENT TREATMENT

Male animals subjected to sham or orchidectomy were treated with external administration of testosterone or its vehicle (45% 2-Hydroxypropyl- β -cyclodextrin in water), as a mean to substitute natural testosterone production. To achieve long-lasting and gradual liberation of the hormone, we used osmotic minipumps from Alzet (Model 2004, 0.23 μ l/h for 28 days). Animals were anesthetized with ketamine (75 mg/kg) and xylazine (15 mg/kg) and then a small-access incision was made in the skin between the scapulae. Minipumps were

implanted subcutaneously and the incision was closed with two silk knots (6-0 black silk 8065195601, Alcon Cusi S.A). The devices were set for a steady-state testosterone delivery of 6 µg/h, an infusion rate that elicited significant behavioural and cellular changes in orchidectomized mice^{295,314}. Experimentation with the animals continued 3 days after implantation. Minipumps were checked after the end of the experiments to ensure that the correct amount of liquid had been extruded.

7. ESTROUS CYCLE DETERMINATION

The phase of the oestrous cycle was determined by histological examination of vaginal smears, as previously described¹³⁹. Briefly, mice were gently restrained and 20 µl of saline were flushed in and out into the vagina. The resulting smear was placed onto gelatinized slides, dried, stained with crystal violet and observed at 40× magnification under a light microscope (DM6000 B, Leica Biosystems, Nussloch, Germany).

Vaginal smear cytology: The types of cells indicated the oestrous state of the animal; dominating squamous cells indicated estrous, inflammatory small black cells among sparse squamous cells indicated metestrus, combination of some squamous cells, small black inflammatory cells and some nucleated cells indicated diestrus and finally, predominant nucleated round cells forming groups indicated proestrus (**Figure 68**).

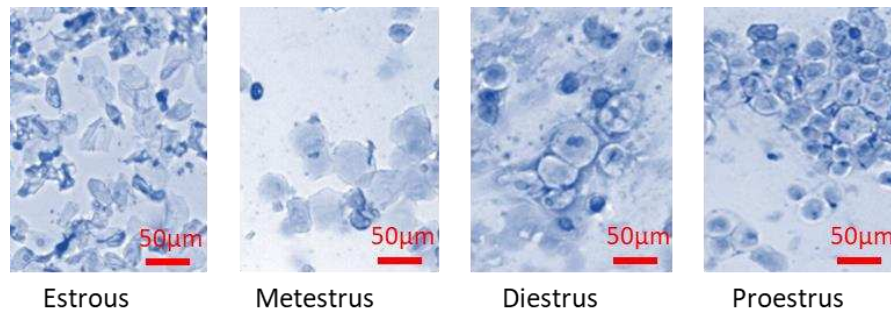

Figure 68. Vaginal smear cytology Each phase of the estrous cycle presents different types of cells. Samples from estrous cycle are characterized by clusters of squamous cells, metestrus presents less amounts of squamous cells plus inflammatory small dark cells, during the diestrus it is possible to observe nucleated, inflammatory and some squamous cells, finally, the proestrus is dominated by clusters of nucleated cells.

To analyse the behaviour of the mice according to their hormonal status, animals of the different oestrous cycle groups were subdivided into those that were in stages of low oestrogen levels (estrous) and those in stages of high oestrogen levels (proestrus, metestrus and diestrus), as previously described^{139,315,316}.

8. MEASUREMENT OF THE ADRENAL GLANDS

Adrenal glands were freshly dissected and placed in a petri dish with saline kept at 4 °C to avoid dehydration. After removing the adjacent fat tissue under a dissecting microscope using 25 G needles, excess water was removed with filter paper and glands' weight measurements were conducted using a high precision balance.

2. CELLULAR EXPERIMENTS

1. DRUGS FOR IN-VITRO STUDIES

Experimental substances were applied at the following vehicle concentrations: 100 μ M AITC (W203408, Merck) was dissolved in 0.001 % DMSO, 100 nM WS12 (3040/50, Tocris) dissolved in 0.001 % ethanol, Nitroglycerin, Testosterone 10 pM dissolved in 0.0001% ethanol, Ionomycin (I9657 Merck). Primary cultures from trigeminal ganglia: Cells were kept in a hormone-free culture medium consisting of Dulbecco's Modified Eagle Medium/F12 (DMEM/F12) without Phenol Red (11039021, Thermo Fisher Scientific), MEM Vitamin Solution 1X (11120052, Thermo Fisher Scientific), Penicillin/Streptomycin 1% (15140-022, Thermo Fisher Scientific) and home-made N2-containing insulin 4 μ g/ml (I2643, Merck), Putrescine hydrochloride 0.1 mM (P7505, Merck), Sodium Selenite 3 nM (S5261 Merck), Transferrin 100 μ g/mL (T2872, Molecular Probes, Eugene, USA) and NGF 25 ng/ml (G5141, Promega, Madison, USA) and hGDNF 25 ng/ml (450-10, Peprotech, London, UK). The enzymes used in the different experiments were always kept as indicated by the provider to avoid degradation and loss of function: collagenase type XI (0,67 mg/mL, Sigma) and dispase type II (3 mg/mL, Gibco for disaggregation during 40

2. TRIGEMINAL GANGLION CULTURE

Animals were sacrificed by cervical dislocation followed by decapitation. The skin of the head was removed and an incision was made through the sagittal and temporal sutures of the cranium. Then, the superior portion of the cranium was removed without affecting the base, protecting the integrity of the trigeminal ganglia. The brain was then removed, exposing the trigeminal ganglia at both sides of the optic chiasm in the base of the skull. Nerves were cut and ganglia were extracted and placed in a cold mixture of neuronal culture medium and HBSS without Ca²⁺ and Mg²⁺ (Gibco) in 1:1 proportion. Once extracted, the integral trigeminal ganglion presents a characteristic Y form, tissue was dissected

selecting the regions where the cell bodies reside (**Figure 69**). Clean trigeminal ganglia are cut in half and placed on an enzymatic mixture with collagenase type XI (0,67 mg/mL, Sigma) and dispase type II (3 mg/mL, Gibco for disaggregation during 40 minutes. After withdrawing the enzymatic mixture, mechanical disaggregation is conducted by pipetting up and down the ganglia. The turbid tissue is then placed over a solution of 15% BSA (Sigma) and centrifuged at 1200 RCF for 7 minutes, separating the tissue remainings from the cells. Then, pelleted cells were washed with medium, the centrifugation repeated and the pelleted cells seeded in droplets of 5 μ L over prepared coverslips of 12 mm diameter pre-treated with Poly-L-Lysine 8.3 μ g/ml (P9155, Merck) and laminin 5 μ g/ml (L2020, Merck) and incubated for 12-16 h at 37°C and 5% CO₂.

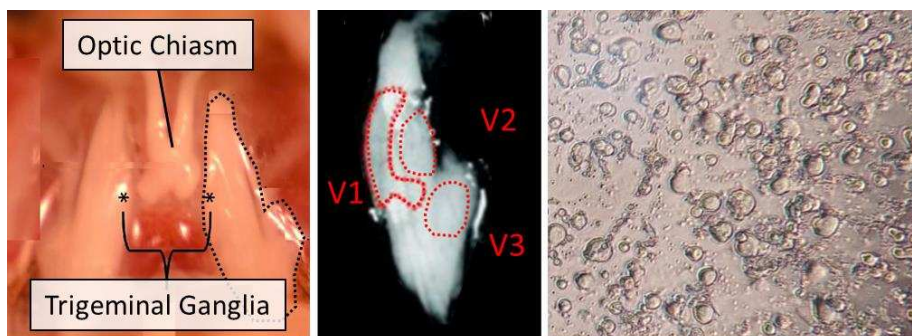

Figure 69 Trigeminal ganglia dissection. Trigeminal ganglia are localized in the base of the cranium lateral to the optic chiasm and rostral to the pituitary gland (not shown in the image). In order to extract intact trigeminal ganglia, the three afferents must be cut. Trigeminal ganglia present the neuronal somata for each trigeminal branch (V1, V2 and V3) grouped as explained in the image, only these segments were collected.

3. CALCIUM IMAGING

Calcium experiments were performed with non-ratiometric fluorescent probe fluo4-AM (F14201, Thermo Fisher Scientific). Cells were incubated 60 minutes at 37 °C with a loading buffer containing 6 mg/ml fluo4-AM and 0.2% w/v pluronic acid (F-127, Thermo Fisher Scientific) dissolved in HBSS (HANKS balanced salt solution) (NaCl 140 mM, KCl 3 mM, CaCl₂ 2.4m M, MgCl₂ 1.3 mM, HEPES 10 mM,

and glucose mM, adjusted to pH 7.4 with NaOH 1M). In order to remove excess of fluorophore, cells were washed with HBSS for at least 20 minutes. Calcium imaging experiments were performed in an inverted microscope (Axiovert 200/B, ZEISS) mounted with a camera Hamamatsu Flash 4.0 LT (C11440-42U30, Hamamatsu, Sunayama-cho, Japan). Cells were individuated using bright field microscopy and regions of interest were drawn by hand. Then, Fluo4 was excited at 480 nm (200-400 ms of excitation time) with a rapid-gating shutter (lambda-shutter 10/2 Sutter instruments, Novato, USA) and photos were taken each 3 s. Using the regions of interest, mean fluorescence intensity was measured for each cell in each time point with HCImage DIA software (Hamamatsu Photonics). Experiments were made at 35 °C. Size of calcium transients were obtained by measuring maximum values after agonist application minus fluorescence values at resting state. To increase comparability, these results were divided by the positive control in each experiment. Calcium transients were counted as positive responses if fluorescence increases were superior to 0.2 arbitrary units. Substances dissolved in HBSS were applied through a perfusion system controlled with automatic valve clamps (PC-16 Bioscience Tools, S. Diego, USA) for periods of 10 to 30 s. Cells were washed with extracellular solution between calcium responses for a period of at least 300 s to ensure recovery of basal fluorescence levels.

4. CGRP RELEASE

CGRP release assay. Trigeminal cultured cells were first exposed to the exocytosis blocker DD04107 10 μ M (BCN Peptides SA, San Quintí de Mediona, Spain) or its vehicle (saline) for 1h. Afterwards, nitroglycerin 100 μ M or its vehicle (5% dextrose and 0.105% propylene glycol) were co-applied with DD04107 10 μ M or its vehicle for 30 additional min. Incubation solutions were made in culture medium and kept at 37°C and 5% CO₂.

Immunocytochemistry. 30 min after nitroglycerin exposure (vehicle 5% dextrose and 0.105% propylene glycol), the media was removed from the cells and the culture was washed with PBS 1X (D8662, Merck) 3 times. Afterwards, paraformaldehyde 4% (158127, Merck) was applied for 20 min at room temperature. Permeabilization was achieved with Triton 100X 0.1% v/v (P8787, Merck) for 5 min and blocking with 5% Normal Goat Serum (NGS, G9023, Merck) for 1 h, both in PBS 1X. Neurons were labelled with rabbit anti-MAP 1:250 (17490-1-AP, LabClinics, Barcelona, Spain) and mouse anti-CGRP 1:200 (AB81887, Abcam, Cambridge, UK). Secondary antibodies were Goat anti-rabbit Alexa 488 1:1000 (A11034, Thermo Fisher Scientific) and Goat anti-mouse Alexa 568 1:1000 (SAB4600400, Merck). Nuclei were stained with DAPI 1.5:10000 (D9564, Merck). Slides were mounted with mowiol (475904, Merck) and images taken with a confocal microscope (LSM 900, ZEISS, Jena, Germany). Mean fluorescence intensity for each cell was obtained, and the average value of positive cells was calculated for each picture.

5. HEK CULTURES

Human embryonic kidney 293 cells (HEK293) were maintained in DMEM plus Glutamax, supplemented with 10% Fetal Bovine Serum (FBS, Thermo Fisher Scientific) and 1% penicillin/streptomycin (Gibco) and incubated at 37°C in a 5% CO₂ atmosphere. For the nitroglycerin/AITC experiment, HEK293 cells were plated in 24-well dishes at 2x10⁵ cells/well and transiently transfected with Human TRPA1 in a pCMV6-AC-GFP vector (Viktorie Vlachova, Czech Academy of Sciences) using Lipofectamine 3000 (Thermo Fisher Scientific). For the transfection, 2 ml of Lipofectamine 3000 was mixed with the DNA in DMEM plus Glutamax with 1% FBS, a reduced serum media. Control cells received the media without the vector. Calcium imaging recordings took place 24 h after transfection. For the testosterone/WS-12 experiment, TRPM8-permanently transfected cells were obtained from Prof. Belmonte Laboratory (Instituto de Neurociencias, San

Juan, Alicante, Spain). IMR90 fibroblast (CCL-186 ATCC, Virginia, USA) were seeded in 12 mm coverslips at 50.000 cells/well and were maintained in Minimum Essential Medium (MEM) enriched with 10% FBS and penicillin/streptomycin 1% at 37°C in a 5% CO₂ atmosphere. The cells were seeded in 12 mm coverslips at 50.000 cells/well and were maintained in Minimum Essential Medium (MEM) enriched with 10% FBS and penicillin/streptomycin 1% at 37°C in a 5% CO₂ atmosphere. IMR90 experiments were performed when confluence reached 50-60%. Cells were kept overnight in a hormone free medium, by eliminating FBS from the composition of the culture medium, substituting MEM or DMEM by no phenol red opti-MEM (Gibco 11058021).

6. RNA PREPARATION AND RTqPCR

Trigeminal ganglia tissue was dissected and cleaned from excess fat tissue because lipids difficult RNA extraction, then samples were dry frozen on dry ice until extraction of RNA. Samples were submerged in 500ul TRIZOL (15596-026 Thermo Fisher Scientific) AND triturated in ice using polytron (Polytron PT 2000 Kinematica AG, Malters, Switzerland), RNA was extracted as explained elsewhere³¹⁷. In brief, we added chloroform to the trizol-tissue homogenate to produce 2 phases, the lipophilic part at the bottom and the hydrophilic part on top with the molecules of RNA. Upon centrifugation, the aqueous phase separated into a new recipient, where RNA was precipitated by the addition of isopropanol. To eliminate reactants of the process, the pellet was washed two times with ethanol and air-dried. Spectrometry ratios 260/230 and 260/280 were used to calculate RNA purity and quantity. (NanoDrop 2000, Thermo Fisher Scientific). Resulting RNA was retrotranscribed to cDNA with First Strand Synthesis Kit (K1612, Thermo Fisher Scientific). We used dT primers to ensure mRNA retrotranscription. Relative expression values were obtained by applying the equation $2^{-(\Delta CT \text{ sample} - \Delta CT \text{ GAPDH})}$. RNA was extracted from cells cultured in microfluidic chambers with E.Z.N.A. MicroElute Total RNA Kit (Omega Bio-TEK)

using a RNA carrier to optimize the amount of RNA extracted. The retrotranscription to cDNA and RTqPCR were performed as described above.

Table 6 Primers for cDNA amplification:

GAPDH	fw 5'- CCAATGTGTCCGTCGTGGATCT rv 5'-GTTGAAGTCGCAG GAGACAACC
TRPM8	fw 5'- CTTTCTAAGCAATGGTATGGAG rv 5'-GGTTTCTTCCTAAATGATACGAG
TRPA1	fw 5'- GCAGGTGGAACCTTCATACCAA fw 5'- CACTTTGCGTAAGTACCAGACTGG
CGRP	fw 5'- TTTCTGGTTGTCAGCATCTT fw 5'- GCGAACTTCTTCTTCACTGAG AGT

3. STATISTICAL ANALYSIS

Time courses of nociceptive behavioural data conducted in male and female mice were analysed using 2-way repeated measures ANOVA with time as within-subjects factor and nitroglycerin treatment or genotype as between-subject factors. The time courses involving orchidectomized animals were analysed with 3-way repeated measures ANOVA, with time as within-subjects factor and either nitroglycerin and orchidectomy or genotype and testosterone as between-subject factors. Levene's test of equality of error variances and Mauchly's sphericity tests were used to assess normality of the data and Bonferroni post-hoc pairwise comparisons were subsequently conducted when appropriate. Three-way ANOVA was also used to analyse the data of WS12 experiments (time point, WS12, nitroglycerin) whereas a within-design was chosen to analyse the effects of the AMTB doses in wild-type males recovered from sensitization (Friedman's test followed by Benjamini adjustment). A 3-way ANOVA was also

used to analyse AMTB effects on nitroglycerin-exposed orchietomized animals (Time point, Testosterone, Genotype). The time-course data of the chemically-induced nocifensive behaviour was analysed with repeated unadjusted t-tests to avoid assumptions of similar variances for the first and the second phases of the formalin test and posterior measurements. For the cellular studies, data normality was first assessed with the D'Agostino-Pearson test. Comparisons of 2 groups were analysed accordingly with T-tests or Mann-Whitney-U tests. Comparisons of more than 2 groups were analysed with either One-way ANOVA followed by Bonferroni or Kruskal-Wallis followed by Mann-Whitney-U tests. RT-PCR and cellular data containing 2 factors were analysed with 2-way ANOVA followed by Bonferroni.

-I'm simply saying that life, uh... finds a way. -

Jurassic Park; Michael Crichton

REFERENCES

1. Terminology | International Association for the Study of Pain. Available at: <https://www.iasp-pain.org/resources/terminology/#pain>. (Accessed: 16th September 2021)
2. Bonica, J. History of pain concepts and pain therapy. *Mt Sinai J Med* **58**, 191–202 (1991).
3. Perl, E. Ideas about pain, a historical view. *Nat. Rev. Neurosci.* **8**, 71–80 (2007).
4. Yasaei, R., Peterson, E. & Saadabadi, A. Chronic Pain Syndrome. *StatPearls* (2021).
5. Phillips, C. J. The Cost and Burden of Chronic Pain. *Rev. Pain* **3**, 2–5 (2009).
6. *Relieving pain in America: A blueprint for transforming prevention, care, education, and research. Relieving Pain in America: A Blueprint for Transforming Prevention, Care, Education, and Research* (National Academies Press, 2011). doi:10.17226/13172
7. James, S. L. *et al.* Global, regional, and national incidence, prevalence, and years lived with disability for 354 Diseases and Injuries for 195 countries and territories, 1990–2017: A systematic analysis for the Global Burden of Disease Study 2017. *Lancet* **392**, 1789–1858 (2018).
8. Van Hecke, O., Torrance, N. & Smith, B. H. Chronic pain epidemiology and its clinical relevance. *Br. J. Anaesth.* **111**, 13–18 (2013).
9. Cohen, S. P., Vase, L. & Hooten, W. M. Chronic pain: an update on burden, best practices, and new advances. *The Lancet* **397**, 2082–2097 (2021).
10. Liu, N. J., Von Gizycki, H. & Gintzler, A. R. Sexually dimorphic recruitment of spinal opioid analgesic pathways by the spinal application of morphine. *J. Pharmacol. Exp. Ther.* **322**, 654–660 (2007).
11. Sharma, S., Blyth, F. M., Mishra, S. R. & Briggs, A. M. Health system strengthening is needed to respond to the burden of pain in low-and middle-income countries and to support healthy ageing. *J. Glob. Health* **9**, (2019).
12. James, S. L. *et al.* Global, regional, and national incidence, prevalence, and years lived with disability for 354 Diseases and Injuries for 195 countries and territories, 1990–2017: A systematic analysis for the Global Burden of Disease Study 2017. *Lancet* **392**, 1789–1858 (2018).

13. Rice, A. S. C., Smith, B. H. & Blyth, F. M. Pain and the global burden of disease. *Pain* **157**, 791–796 (2016).
14. Yekkirala, A. S., Roberson, D. P., Bean, B. P. & Woolf, C. J. Breaking barriers to novel analgesic drug development. *Nat. Rev. Drug Discov.* **16**, 545–564 (2017).
15. Vardeh, D., Mannion, R. J. & Woolf, C. J. Toward a Mechanism-Based Approach to Pain Diagnosis. *Journal of Pain* **17**, T50–T69 (2016).
16. Gold, M. S. & Gebhart, G. F. Nociceptor sensitization in pain pathogenesis. *Nature Medicine* **16**, 1248–1257 (2010).
17. R, B. Neuropathic pain: a clinical perspective. *Handb. Exp. Pharmacol.* **194**, 3–30 (2009).
18. Basbaum, A. I., Bautista, D. M., Scherrer, G. & Julius, D. Cellular and Molecular Mechanisms of Pain. *Cell* **139**, 267–284 (2009).
19. E, G. & A, M. Heterogeneity in primary nociceptive neurons: from molecules to pathology. *Arch. Pharm. Res.* **33**, 1489–1507 (2010).
20. Eric R. Kandel; James H. Schwartz; Thomas M. Jessell; Steven A. Siegelbaum; A.J.Hudspeth. *Principles of Neural Science - Fifth edition*. (McGRAW-HILL, 2013).
21. Merskey, H. & Bogduk, N. *Classification of Chronic Pain: Descriptions of Chronic Pain Syndromes and Definitions of Pain Terms, 2nd Edn Seattle (WA): IASP Press*. (1994).
22. Dubin, A. E. & Patapoutian, A. Nociceptors: The sensors of the pain pathway. *Journal of Clinical Investigation* **120**, 3760–3772 (2010).
23. Lewin, G. R. & Moshourab, R. Mechanosensation and pain. *Journal of Neurobiology* **61**, 30–44 (2004).
24. Smith, E. S. J. & Lewin, G. R. Nociceptors: a phylogenetic view. *Journal of comparative physiology. A, Neuroethology, sensory, neural, and behavioral physiology* **195**, 1089–1106 (2009).
25. Devesa, I. *et al.* α CGRP is essential for algescic exocytotic mobilization of TRPV1 channels in peptidergic nociceptors. *Proc. Natl. Acad. Sci. U. S. A.* **111**, 18345–18350 (2014).
26. Usoskin, D. *et al.* Unbiased classification of sensory neuron types by large-scale single-cell RNA sequencing. *Nat. Neurosci.* **18**, 145–153 (2015).

27. Robinson, D. R. & Gebhart, G. F. Inside information: The unique features of visceral sensation. *Molecular Interventions* **8**, 242–253 (2008).
28. Himmel, N. J. & Cox, D. N. Transient receptor potential channels: current perspectives on evolution. *Proceedings of the Royal Society B: Biological Sciences* **287**, (2020).
29. Chanda, M. L. & Mogil, J. S. Sex differences in the effects of amiloride on formalin test nociception in mice. *Am. J. Physiol. - Regul. Integr. Comp. Physiol.* **291**, 335–342 (2006).
30. Hu, J. *et al.* Alpha-lipoic Acid suppresses P2X receptor activities and visceral hypersensitivity to colorectal distention in diabetic rats. *Sci. Rep.* **7**, (2017).
31. Gold, M. S. & Caterina, M. J. 5 . 04 Molecular Biology of the Nociceptor / Transduction. in *The Senses: A Comprehensive Reference*. 43–73 (2008).
32. Li, Z. *et al.* Membrane protein Nav1.7 contributes to the persistent post-surgical pain regulated by p-p65 in dorsal root ganglion (DRG) of SMIR rats model. *BMC Anesthesiol.* **17**, (2017).
33. Hu, J. *et al.* Colonic hypersensitivity and sensitization of voltage-Gated sodium channels in primary sensory neurons in rats with diabetes. *J. Neurogastroenterol. Motil.* **22**, 129–140 (2016).
34. Yan, J. *et al.* Hyperexcitability and sensitization of sodium channels of dorsal root ganglion neurons in a rat model of lumbar disc herniation. *Eur. Spine J.* **25**, 177–185 (2016).
35. Nojima, D. *et al.* Efficacy of anti-Nav1.7 antibody on the sensory nervous system in a rat model of lumbar intervertebral disc injury. *Yonsei Med. J.* **57**, 748–753 (2016).
36. Sun, Y. *et al.* α -lipoic acid suppresses neuronal excitability and attenuates colonic hypersensitivity to colorectal distention in diabetic rats. *J. Pain Res.* **10**, 1645–1655 (2017).
37. Ritter, A. M. & Mendell, L. M. Somal membrane properties of physiologically identified sensory neurons in the rat: Effects of nerve growth factor. *J. Neurophysiol.* **68**, 2033–2041 (1992).
38. Baumann, T. K., Chaudhary, P. & Martenson, M. E. Background potassium channel

- block and TRPV1 activation contribute to proton depolarization of sensory neurons from humans with neuropathic pain. *Eur. J. Neurosci.* **19**, 1343–1351 (2004).
39. Kirchhoff, C., Leah, J. D., Jung, S. & Reeh, P. W. Excitation of cutaneous sensory. Nerve endings in the rat by 4- aminopyridine and tetraethylammonium. *J. Neurophysiol.* **67**, 125–131 (1992).
 40. Patel, A. J., Lazdunski, M. & Honoré, E. Lipid and mechano-gated 2P domain K⁺ channels. *Current Opinion in Cell Biology* **13**, 422–428 (2001).
 41. Rietmeijer, R. A., Sorum, B., Li, B. & Brohawn, S. G. Physical basis for distinct basal and mechanically gated activity of the human K⁺ channel TRAAK. *Neuron* **109**, 2902-2913.e4 (2021).
 42. Brohawn, S. G. How ion channels sense mechanical force: Insights from mechanosensitive K2P channels TRAAK, TREK1, and TREK2. *Ann. N. Y. Acad. Sci.* **1352**, 20–32 (2015).
 43. Schneider, E. R., Anderson, E. O., Gracheva, E. O. & Bagriantsev, S. N. Temperature Sensitivity of Two-Pore (K2P) Potassium Channels. in *Current Topics in Membranes* **74**, 113–133 (Academic Press Inc., 2014).
 44. Dai, Y. *et al.* Sensitization of TRPA1 by PAR2 contributes to the sensation of inflammatory pain. *J. Clin. Invest.* **117**, 1979–1987 (2007).
 45. Russell, F. A., Veldhoen, V. E., Tchitchkan, D. & McDougall, J. J. Proteinase-activated receptor-4 (PAR4) activation leads to sensitization of rat joint primary afferents via a bradykinin B2 receptor-dependent mechanism. *J. Neurophysiol.* **103**, 155–163 (2010).
 46. Potrebic, S., Ahn, A. H., Skinner, K., Fields, H. L. & Basbaum, A. I. Peptidergic Nociceptors of Both Trigeminal and Dorsal Root Ganglia Express Serotonin 1D Receptors: Implications for the Selective Antimigraine Action of Triptans. *J. Neurosci.* **23**, 10988–10997 (2003).
 47. Patil, M. J., Jeske, N. A. & Akopian, A. N. Transient receptor potential V1 regulates activation and modulation of transient receptor potential A1 by Ca²⁺. *Neuroscience* **171**, 1109–1119 (2010).
 48. Mousa, S. A. Morphological correlates of immune-mediated peripheral opioid

- analgesia. *Advances in Experimental Medicine and Biology* **521**, 77–87 (2003).
49. Rukwied, R. *et al.* NGF induces non-inflammatory localized and lasting mechanical and thermal hypersensitivity in human skin. *Pain* **148**, 407–413 (2010).
 50. Abbadie, C. *et al.* Chemokines and pain mechanisms. *Brain Research Reviews* **60**, 125–134 (2009).
 51. Schaible, H. G. *et al.* The role of proinflammatory cytokines in the generation and maintenance of joint pain: Annals of the New York Academy of Sciences. in *Annals of the New York Academy of Sciences* **1193**, 60–69 (Ann N Y Acad Sci, 2010).
 52. Raddant, A. C. & Russo, A. F. Calcitonin gene-related peptide in migraine: intersection of peripheral inflammation and central modulation. *Expert reviews in molecular medicine* **13**, (2011).
 53. Yazdkhasti, M., Hanjani, S. M. & Tourzani, Z. M. The effect of localized heat and cold therapy on pain intensity, duration of phases of labor, and birth outcomes among primiparous females: A randomized, controlled trial. *Shiraz E Med. J.* **19**, (2018).
 54. Su, H. C. *et al.* Using vibrating and cold device for pain relieves in children: A systematic review and meta-analysis of randomized controlled trials. *J. Pediatr. Nurs.* **61**, 23–33 (2021).
 55. East, C. E., Dorward, E. D. F., Whale, R. E. & Liu, J. Local cooling for relieving pain from perineal trauma sustained during childbirth. *Cochrane Database Syst. Rev.* **2020**, (2020).
 56. Wattiez, A. S., Sowers, L. P. & Russo, A. F. Calcitonin gene-related peptide (CGRP): role in migraine pathophysiology and therapeutic targeting. *Expert Opinion on Therapeutic Targets* **24**, 91–100 (2020).
 57. McEntire, D. M. *et al.* Pain transduction: a pharmacologic perspective. *Expert Review of Clinical Pharmacology* **9**, 1069–1080 (2016).
 58. Souza Monteiro de Araujo, D., Nassini, R., Geppetti, P. & De Logu, F. TRPA1 as a therapeutic target for nociceptive pain. *Expert Opinion on Therapeutic Targets* **24**, 997–1008 (2020).
 59. Zygmunt, P. M. & Högesättt, E. D. TRPA1. *Handb. Exp. Pharmacol.* **222**, 583–630 (2014).

60. Richardson, J. D. & Vasko, M. R. *Cellular mechanisms of neurogenic inflammation. Journal of Pharmacology and Experimental Therapeutics* **302**, 839–845 (American Society for Pharmacology and Experimental Therapeutics, 2002).
61. Iyengar, S., Johnson, K. W., Ossipov, M. H. & Aurora, S. K. CGRP and the Trigeminal System in Migraine. *Headache* **59**, 659–681 (2019).
62. Oo, W. M. & Hunter, D. J. Nerve Growth Factor (NGF) Inhibitors and Related Agents for Chronic Musculoskeletal Pain: A Comprehensive Review. *BioDrugs* **35**, 611–641 (2021).
63. Wise, B. L., Seidel, M. F. & Lane, N. E. The evolution of nerve growth factor inhibition in clinical medicine. *Nature Reviews Rheumatology* **17**, 34–46 (2021).
64. Murdaca, G., Colombo, B. M. & Puppo, F. Anti-TNF- α inhibitors: A new therapeutic approach for inflammatory immune-mediated diseases: An update upon efficacy and adverse events. *International Journal of Immunopathology and Pharmacology* **22**, 557–565 (2009).
65. Rao, S. S. C. *et al.* Randomised clinical trial: linaclotide vs placebo—a study of bi-directional gut and brain axis. *Aliment. Pharmacol. Ther.* **51**, 1332–1341 (2020).
66. Bharucha, A. E. & Linden, D. R. Linaclotide - A secretagogue and antihyperalgesic agent - What next? *Neurogastroenterology and Motility* **22**, 227–231 (2010).
67. Ferrari, M. D. *et al.* Migraine. *Nat. Rev. Dis. Prim.* **8**, 2 (2022).
68. AM, U. & Unruh, A. M. Gender variations in clinical pain experience. *Pain* **65**, 123–167 (1996).
69. Atherton, K. & Power, C. Health inequalities with the National Statistics-Socioeconomic classification: Disease risk factors and health in the 1958 British birth cohort. *Eur. J. Public Health* **17**, 486–491 (2007).
70. LeResche, L. Defining gender disparities in pain management. *Clinical Orthopaedics and Related Research* **469**, 1871–1877 (2011).
71. Lillefjell, M. Gender differences in psychosocial influence and rehabilitation outcomes for work-disabled individuals with chronic musculoskeletal pain. *J. Occup. Rehabil.* **16**, 659–674 (2006).
72. Richardson, J. & Holdcroft, A. Gender differences and pain medication. *Women's Health* **5**, 79–90 (2009).

73. Mogil, J. S. & JS, M. Sex differences in pain and pain inhibition: multiple explanations of a controversial phenomenon. *Nat. Rev. Neurosci.* **13**, 859–866 (2012).
74. Bartley, E. J. & Fillingim, R. B. Sex differences in pain: A brief review of clinical and experimental findings. *Br. J. Anaesth.* **111**, 52–58 (2013).
75. Fillingim, R. B., King, C. D., Ribeiro-Dasilva, M. C., Rahim-Williams, B. & Riley, J. L. Sex, Gender, and Pain: A Review of Recent Clinical and Experimental Findings. *J. Pain* **10**, 447–485 (2009).
76. Kannan, V. D. & Veazie, P. J. Who Avoids Going to the Doctor and Why? Audience Segmentation Analysis for Application of Message Development. *Health Commun.* **30**, 635–645 (2015).
77. Abraham, A. *et al.* Sex differences in neuropathic pain intensity in diabetes. *J. Neurol. Sci.* **388**, 103–106 (2018).
78. Cardinez, N. *et al.* Sex differences in neuropathic pain in longstanding diabetes: Results from the Canadian Study of Longevity in Type 1 Diabetes. *J. Diabetes Complications* **32**, 660–664 (2018).
79. Rosen, S., Ham, B. & Mogil, J. Sex differences in neuroimmunity and pain. *J. Neurosci. Res.* **95**, 500–508 (2017).
80. Kim, J. R. & Kim, H. A. Molecular mechanisms of sex-related differences in arthritis and associated pain. *International Journal of Molecular Sciences* **21**, 1–21 (2020).
81. Bair, E. *et al.* Identification of clusters of individuals relevant to temporomandibular disorders and other chronic pain conditions: The OPPERA study. *Pain* **157**, 1266–1278 (2016).
82. Zheng, H. *et al.* Age and preoperative pain are major confounders for sex differences in postoperative pain outcome: A prospective database analysis. *PLoS One* **12**, (2017).
83. Ruau, D., Liu, L. Y., Clark, J. D., Angst, M. S. & Butte, A. J. Sex differences in reported pain across 11,000 patients captured in electronic medical records. *J. Pain* **13**, 228–234 (2012).
84. Gobina, I. *et al.* Prevalence of self-reported chronic pain among adolescents: Evidence from 42 countries and regions. *Eur. J. Pain (United Kingdom)* **23**, 316–

- 326 (2019).
85. Traub, R. J. & Ji, Y. Sex differences and hormonal modulation of deep tissue pain. *Front. Neuroendocrinol.* **34**, 350–366 (2013).
 86. Houghton, L. A., Lea, R., Jackson, N. & Whorwell, P. J. The menstrual cycle affects rectal sensitivity in patients with irritable bowel syndrome but not healthy volunteers. *Gut* **50**, 471–474 (2002).
 87. Patil, M. J., Green, D. P., Henry, M. A. & Akopian, A. N. Sex-dependent roles of prolactin and prolactin receptor in postoperative pain and hyperalgesia in mice. *Neuroscience* **253**, 132–141 (2013).
 88. Chen, Y., Navratilova, E., Dodick, D. W. & Porreca, F. An Emerging Role for Prolactin in Female-Selective Pain. *Trends in Neurosciences* **43**, 635–648 (2020).
 89. González, S. L. *et al.* Allopregnanolone and Progesterone in Experimental Neuropathic Pain: Former and New Insights with a Translational Perspective. *Cellular and Molecular Neurobiology* **39**, 523–537 (2019).
 90. Sharp, J. L., Pearson, T. & Smith, M. A. Sex differences in opioid receptor mediated effects: Role of androgens. *Neurosci. Biobehav. Rev.* **134**, 104522 (2022).
 91. Nag, S. & Mokha, S. S. Testosterone is essential for α 2-adrenoceptor-induced antinociception in the trigeminal region of the male rat. *Neurosci. Lett.* **467**, 48–52 (2009).
 92. Nag, S. & Mokha, S. S. Activation of the trigeminal α 2-adrenoceptor produces sex-specific, estrogen dependent thermal antinociception and antihyperalgesia using an operant pain assay in the rat. *Behav. Brain Res.* **314**, 152–158 (2016).
 93. White, H. D. & Robinson, T. D. A novel use for testosterone to treat central sensitization of chronic pain in fibromyalgia patients. *Int. Immunopharmacol.* **27**, 244–248 (2015).
 94. Bartley, E. J. *et al.* Natural Variation in Testosterone is Associated with Hypoalgesia in Healthy Women. *Clin. J. Pain* **31**, 730–739 (2015).
 95. Aloisi, A. M. *et al.* Cross-sex hormone administration changes pain in transsexual women and men. *Pain* **132**, (2007).
 96. Bai, X., Zhang, X. & Zhou, Q. Effect of Testosterone on TRPV1 Expression in a Model of Orofacial Myositis Pain in the Rat. *J. Mol. Neurosci.* **64**, 93–101 (2018).

97. Seol, S. H. & Chung, G. Estrogen-dependent regulation of transient receptor potential vanilloid 1 (TRPV1) and P2X purinoceptor 3 (P2X3): Implication in burning mouth syndrome. *Journal of Dental Sciences* **17**, (2021).
98. Payrits, M. *et al.* Estradiol sensitizes the transient receptor potential vanilloid 1 receptor in pain responses. *Endocrinology* **158**, 3249–3258 (2017).
99. Xu, S., Cheng, Y., Keast, J. R. & Osborne, P. B. 17 β -estradiol activates estrogen receptor β -signalling and inhibits transient receptor potential vanilloid receptor 1 activation by capsaicin in adult rat nociceptor neurons. *Endocrinology* **149**, 5540–5548 (2008).
100. Nersesyan, Y. *et al.* Oxytocin Modulates Nociception as an Agonist of Pain-Sensing TRPV1. *Cell Rep.* **21**, 1681–1691 (2017).
101. Harteneck, C. Pregnenolone sulfate: From steroid metabolite to TRP channel ligand. *Molecules* **18**, 12012–12028 (2013).
102. Vandewauw, I. *et al.* A TRP channel trio mediates acute noxious heat sensing. *Nature* **555**, 662–666 (2018).
103. Sorge, R. E. *et al.* Different immune cells mediate mechanical pain hypersensitivity in male and female mice. *Nat. Neurosci.* **18**, 1081–1083 (2015).
104. Taves, S. *et al.* Spinal inhibition of p38 MAP kinase reduces inflammatory and neuropathic pain in male but not female mice: Sex-dependent microglial signaling in the spinal cord. *Brain. Behav. Immun.* **55**, 70–81 (2016).
105. Nasser, S. A. & Afify, E. A. Sex differences in pain and opioid mediated antinociception: Modulatory role of gonadal hormones. *Life Sciences* **237**, (2019).
106. Berkley, K. J. Sex differences in pain. *Beha* **20**, 371–380 (1997).
107. Doyle, H. H. *et al.* Sex Differences in Microglia Activity within the Periaqueductal Gray of the Rat: A Potential Mechanism Driving the Dimorphic Effects of Morphine. *J. Neurosci.* **37**, 3202–3214 (2017).
108. Kumar, A., Liu, N. J., Madia, P. A. & Gintzler, A. R. Contribution of Endogenous Spinal Endomorphin 2 to Intrathecal Opioid Antinociception in Rats Is Agonist Dependent and Sexually Dimorphic. *J. Pain* **16**, 1200–1210 (2015).
109. Calizo, L. H. & Flanagan-Cato, L. M. Estrogen-induced dendritic spine elimination on female rat ventromedial hypothalamic neurons that project to the

- periaqueductal gray. *J. Comp. Neurol.* **447**, 234–248 (2002).
110. Girard-Tremblay, L. *et al.* Sex differences in the neural representation of pain unpleasantness. *J. Pain* **15**, 867–877 (2014).
 111. Wang, G., Erpelding, N. & Davis, K. D. Sex differences in connectivity of the subgenual anterior cingulate cortex. *Pain* **155**, 755–763 (2014).
 112. Hong, J. Y. *et al.* Sex and disease-related alterations of anterior insula functional connectivity in chronic abdominal pain. *J. Neurosci.* **34**, 14252–14259 (2014).
 113. Jin, Q. *et al.* Sex-related differences in resting-state brain activity and connectivity in the orbital frontal cortex and insula in patients with functional constipation. *Neurogastroenterol. Motil.* **31**, (2019).
 114. Behbehani, M. M. Functional characteristics of the midbrain periaqueductal gray. *Progress in Neurobiology* **46**, 575–605 (1995).
 115. Gamal-Eltrabily, M., Martínez-Lorenzana, G., González-Hernández, A. & Condés-Lara, M. Cortical Modulation of Nociception. *Neuroscience* **458**, 256–270 (2021).
 116. Oliva, V. *et al.* Parallel cortical-brainstem pathways to attentional analgesia. *Neuroimage* **226**, (2021).
 117. Liang, S. H. *et al.* A neural circuit from thalamic paraventricular nucleus to central amygdala for the facilitation of neuropathic pain. *J. Neurosci.* **40**, 7837–7854 (2020).
 118. Boyer, J. S., Morgan, M. M. & Craft, R. M. Microinjection of morphine into the rostral ventromedial medulla produces greater antinociception in male compared to female rats. *Brain Res.* **796**, 315–318 (1998).
 119. Bernal, S. A., Morgan, M. M. & Craft, R. M. PAG mu opioid receptor activation underlies sex differences in morphine antinociception. *Behav. Brain Res.* **177**, 126–133 (2007).
 120. Pisanu, C. *et al.* Sex differences in the response to opioids for pain relief: A systematic review and meta-analysis. *Pharmacological Research* **148**, (2019).
 121. Shane, R., Bernal, S. Y., Rozengurtel, S. & Bodnar, R. J. Estrus phase differences in female rats in morphine antinociception elicited from the ventrolateral periaqueductal gray. *Int. J. Neurosci.* **117**, 811–822 (2007).
 122. Murphy, A. Z., Shupnik, M. A. & Hoffman, G. E. Androgen and estrogen (α)

- receptor distribution in the periaqueductal gray of the male rat. *Horm. Behav.* **36**, 98–108 (1999).
123. Loyd, D. R. & Murphy, A. Z. Androgen and estrogen (α) receptor localization on periaqueductal gray neurons projecting to the rostral ventromedial medulla in the male and female rat. *J. Chem. Neuroanat.* **36**, 216–226 (2008).
124. Vanderhorst, V. G. J. M., Schasfoort, F. C., Meijer, E., Van Leeuwen, F. W. & Holstege, G. Estrogen receptor-alpha-immunoreactive neurons in the periaqueductal gray of the adult ovariectomized female cat. *Neurosci. Lett.* **240**, 13–16 (1998).
125. Boers, J., Gerrits, P. O., Meijer, E. & Holstege, G. Estrogen receptor-alpha-immunoreactive neurons in the mesencephalon, pons and medulla oblongata of the female golden hamster. *Neurosci. Lett.* **267**, 17–20 (1999).
126. Turcotte, J. C. & Blaustein, J. D. Immunocytochemical localization of midbrain estrogen receptor- and progesterin receptor-containing cells in female guinea pigs. *J. Comp. Neurol.* **328**, 76–87 (1993).
127. Vanderhorst, V. G. J. M., Terasawa, E. & Ralston, H. J. Estrogen receptor-alpha immunoreactive neurons in the ventrolateral periaqueductal gray receive monosynaptic input from the lumbosacral cord in the rhesus monkey. *J. Comp. Neurol.* **443**, 27–42 (2002).
128. Vanderhorst, V. G. J. M., Terasawa, E. & Ralston, H. J. Projections from estrogen receptor- α immunoreactive neurons in the periaqueductal gray to the lateral medulla oblongata in the rhesus monkey. *Neuroscience* **125**, 243–253 (2004).
129. Averitt, D. L., Eidson, L. N., Doyle, H. H. & Murphy, A. Z. *Neuronal and glial factors contributing to sex differences in opioid modulation of pain. Neuropsychopharmacology* **44**, (2019).
130. Miller, P. L. & Ernst, A. A. Sex Differences in Analgesia: A Randomized Trial of μ versus κ Opioid Agonists. *South. Med. J.* **97**, 35–41 (2004).
131. Cepeda, M. S. & Carr, D. B. Women Experience More Pain and Require More Morphine Than Men to Achieve a Similar Degree of Analgesia. *Anesth. Analg.* **97**, 1464–1468 (2003).
132. Sarton, E. *et al.* Sex differences in morphine analgesia: An experimental study in

- healthy volunteers. *Anesthesiology* **93**, 1245–1254 (2000).
133. Bijur, P. E. *et al.* Response to morphine in male and female patients: Analgesia and adverse events. *Clin. J. Pain* **24**, 192–198 (2008).
 134. Fillingim, R. B. *et al.* Morphine responses and experimental pain: Sex differences in side effects and cardiovascular responses but not analgesia. *J. Pain* **6**, 116–124 (2005).
 135. Glasson, J. C., Sawyer, W. T., Lindley, C. M. & Ginsberg, B. Patient-specific factors affecting patient-controlled analgesia dosing. *J. Pain Palliat. Care Pharmacother.* **16**, 5–21 (2002).
 136. Loyd, D. R., Morgan, M. M. & Murphy, A. Z. Morphine preferentially activates the periaqueductal gray-rostral ventromedial medullary pathway in the male rat: A potential mechanism for sex differences in antinociception. *Neuroscience* **147**, 456–468 (2007).
 137. Mogil, J. S. & Belknap, J. K. Sex and genotype determine the selective activation of neurochemically-distinct mechanisms of swim stress-induced analgesia. *Pharmacol. Biochem. Behav.* **56**, 61–66 (1996).
 138. Sternberg, W. F., Chesler, E. J., Wilson, S. G. & Mogil, J. S. Acute progesterone can recruit sex-specific neurochemical mechanisms mediating swim stress-induced and κ -opioid analgesia in mice. *Horm. Behav.* **46**, 467–473 (2004).
 139. Escudero-Lara, A., Cabañero, D. & Maldonado, R. Kappa opioid receptor modulation of endometriosis pain in mice. *Neuropharmacology* **195**, (2021).
 140. Chakrabarti, S., Liu, N. J. & Gintzler, A. R. Formation of μ -/ κ -opioid receptor heterodimer is sex-dependent and mediates female-specific opioid analgesia. *Proc. Natl. Acad. Sci. U. S. A.* **107**, 20115–20119 (2010).
 141. Liu, N. J., Schnell, S., Wessendorf, M. W. & Gintzler, A. R. Sex, pain, and opioids: Interdependent influences of sex and pain modality on dynorphin-mediated antinociception in rats. *J. Pharmacol. Exp. Ther.* **344**, 522–530 (2013).
 142. Liu, N. J. & Gintzler, A. R. Prolonged ovarian sex steroid treatment of male rats produces antinociception: Identification of sex-based divergent analgesic mechanisms. *Pain* **85**, 273–281 (2000).
 143. Dawson-Basoa, M. E. & Gintzler, A. R. Estrogen and progesterone activate spinal

- kappa-opiate receptor analgesic mechanisms. *Pain* **64**, 169–177 (1996).
144. Lawson, K. P., Nag, S., Thompson, A. D. & Mokha, S. S. Sex-specificity and estrogen-dependence of kappa opioid receptor-mediated antinociception and antihyperalgesia. *Pain* **151**, 806–815 (2010).
 145. Nag, S. & Mokha, S. S. Activation of α 2-adrenoceptors in the trigeminal region produces sex-specific modulation of nociception in the rat. *Neuroscience* **142**, 1255–1262 (2006).
 146. Lee, K. S. *et al.* Androgen receptor transcriptionally regulates μ -opioid receptor expression in rat trigeminal ganglia. *Neuroscience* **331**, 52–61 (2016).
 147. Minke, B. The history of the Drosophila TRP channel: The birth of a new channel superfamily. *J. Neurogenet.* **24**, 216 (2010).
 148. Caterina, M. J. *et al.* The capsaicin receptor: A heat-activated ion channel in the pain pathway. *Nature* **389**, 816–824 (1997).
 149. Jardín, I. *et al.* TRPs in pain sensation. *Frontiers in Physiology* **8**, (2017).
 150. Nilius, B. & Flockerzi, V. Mammalian transient receptor potential (TRP) cation channels. Preface. *Handbook of experimental pharmacology* **223**, (2014).
 151. Venkatachalam, K. & Montell, C. TRP channels. *Annual Review of Biochemistry* **76**, 387–417 (2007).
 152. Yin, Y. *et al.* Structure of the cold- And menthol-sensing ion channel TRPM8. *Science (80-.)*. **359**, 237–241 (2018).
 153. Boonen, B., Startek, J. B. & Talavera, K. Chemical activation of sensory TRP channels. *Top. Med. Chem.* **23**, 73–114 (2017).
 154. García-Sanz, N. *et al.* A role of the transient receptor potential domain of vanilloid receptor I in channel gating. *J. Neurosci.* **27**, 11641–11650 (2007).
 155. McKemy, D. D., Neuhauser, W. M. & Julius, D. Identification of a cold receptor reveals a general role for TRP channels in thermosensation. *Nature* **416**, 52–58 (2002).
 156. Marwaha, L. *et al.* TRP channels: potential drug target for neuropathic pain. *Inflammopharmacology* **24**, 305–317 (2016).
 157. Hung, C. Y. & Tan, C. H. TRP channels in nociception and pathological pain. in *Advances in Experimental Medicine and Biology* **1099**, 13–27 (2018).

158. Moran, M. M. & Szallasi, A. Targeting nociceptive transient receptor potential channels to treat chronic pain: current state of the field. *British Journal of Pharmacology* **175**, 2185–2203 (2018).
159. Kaneko, Y. & Szallasi, A. Transient receptor potential (TRP) channels: A clinical perspective. *British Journal of Pharmacology* **171**, 2474–2507 (2014).
160. Moran, M. M. TRP Channels as Potential Drug Targets. *Annual Review of Pharmacology and Toxicology* **58**, 309–330 (2018).
161. Iannone, L. F., De Logu, F., Geppetti, P. & De Cesaris, F. The role of TRP ion channels in migraine and headache. *Neurosci. Lett.* **768**, 136380 (2022).
162. Oxford, G. S. & Hurley, J. H. The Role of TRP Channels in Migraine. *Open Pain J.* **6**, 37–49 (2013).
163. Wang, S. L., Dai, Y., Liu, X. L. & Zhang, W. S. TRP channels and migraine. *Chinese Pharmacological Bulletin* **29**, 1352–1354 (2013).
164. Dussor, G. *et al.* Targeting TRP channels for novel migraine therapeutics. *ACS Chemical Neuroscience* **5**, 1085–1096 (American Chemical Society, 2014).
165. Liu, Y. *et al.* TRPM8 channels: A review of distribution and clinical role. *European Journal of Pharmacology* **882**, 173312 (2020).
166. Viana, F. TRPA1 channels: molecular sentinels of cellular stress and tissue damage. *J. Physiol.* **594**, 4151–4169 (2016).
167. Weyer, A. D. & Stucky, C. L. Loosening Pain’s Grip by Tightening TRPV1-TRPA1 Interactions. *Neuron* **85**, 661–663 (2015).
168. Fischer, M. J. M. *et al.* Direct evidence for functional TRPV1/TRPA1 heteromers. *Pflugers Arch. Eur. J. Physiol.* **466**, 2229–2241 (2014).
169. Srebro, D., Vučković, S. & Prostran, M. Participation of peripheral TRPV1, TRPV4, TRPA1 and ASIC in a magnesium sulfate-induced local pain model in rat. *Neuroscience* **339**, 1–11 (2016).
170. Raisinghani, M. *et al.* Activation characteristics of transient receptor potential ankyrin 1 and its role in nociception. *Am. J. Physiol. - Cell Physiol.* **301**, (2011).
171. Fernández-Carvajal, A., Fernández-Ballester, G., González-Muñiz, R. & Ferrer-Montiel, A. Pharmacology of TRP channels. in *TRP Channels in Sensory Transduction* 41–71 (2015). doi:10.1007/978-3-319-18705-1_2

172. Antoniazzi, C. T. D. D. C. T. D. D. *et al.* Transient receptor potential ankyrin 1 (TRPA1) plays a critical role in a mouse model of cancer pain. *Int. J. Cancer* **1**, (2018).
173. McNamara, C. R. *et al.* TRPA1 mediates formalin-induced pain. *Proc. Natl. Acad. Sci. U. S. A.* **104**, 13525–13530 (2007).
174. Kwan, K. Y. *et al.* TRPA1 Contributes to Cold, Mechanical, and Chemical Nociception but Is Not Essential for Hair-Cell Transduction. *Neuron* **50**, 277–289 (2006).
175. Fernandes, E. S., Fernandes, M. A. & Keeble, J. E. The functions of TRPA1 and TRPV1: Moving away from sensory nerves. *British Journal of Pharmacology* **166**, 510–521 (2012).
176. Moparthi, L. *et al.* Human TRPA1 is a heat sensor displaying intrinsic U-shaped thermosensitivity. *Sci. Reports 2016 61* **6**, 1–10 (2016).
177. Story, G. M. *et al.* ANKTM1, a TRP-like channel expressed in nociceptive neurons, is activated by cold temperatures. *Cell* **112**, 819–829 (2003).
178. Hoffmann, T. *et al.* TRPA1 and TRPV1 are differentially involved in heat nociception of mice. *Eur. J. Pain (United Kingdom)* **17**, 1472–1482 (2013).
179. Karashima, Y. *et al.* Bimodal action of menthol on the transient receptor potential channel TRPA1. *J. Neurosci.* **27**, 9874–9884 (2007).
180. Wang, G. Ligand-stereoselective allosteric activation of cold-sensing TRPM8 channels by an H-bonded homochiral menthol dimer with head-to-head or head-to-tail. *Chirality* **33**, 783–796 (2021).
181. Iftinca, M. & Altier, C. The cool things to know about TRPM8! *Channels* **14**, 413–420 (2020).
182. Laing, R. J. & Dhaka, A. ThermoTRPs and Pain. *Neuroscientist* **22**, 171–187 (2016).
183. Peier, A. M. *et al.* A TRP channel that senses cold stimuli and menthol. *Cell* **108**, 705–715 (2002).
184. Bautista, D. M. *et al.* The menthol receptor TRPM8 is the principal detector of environmental cold. **448**, 4–9 (2007).
185. Dhaka, A. *et al.* TRPM8 Is Required for Cold Sensation in Mice. *Neuron* **54**, 371–378 (2007).

186. Ordás, P. *et al.* Expression of the cold thermoreceptor TRPM8 in rodent brain thermoregulatory circuits. *J. Comp. Neurol.* **529**, 234–256 (2021).
187. Asuthkar, S. *et al.* The TRPM8 protein is a testosterone receptor: II. Functional evidence for an ionotropic effect of testosterone on TRPM8. *J. Biol. Chem.* **290**, 2670–2688 (2015).
188. Mohandass, A. *et al.* TRPM8 as the rapid testosterone signaling receptor: Implications in the regulation of dimorphic sexual and social behaviors. *FASEB J.* **34**, 10887–10906 (2020).
189. Gavva, N. R. *et al.* Reduced TRPM8 expression underpins reduced migraine risk and attenuated cold pain sensation in humans. *Sci. Rep.* **9**, 1–11 (2019).
190. Proudfoot, C. J. *et al.* Analgesia Mediated by the TRPM8 Cold Receptor in Chronic Neuropathic Pain. *Curr. Biol.* **16**, 1591–1605 (2006).
191. Pérez De Vega, M. J., Gómez-Monterrey, I., Ferrer-Montiel, A. & González-Muñiz, R. Transient Receptor Potential Melastatin 8 Channel (TRPM8) Modulation: Cool Entryway for Treating Pain and Cancer. *Journal of Medicinal Chemistry* **59**, 10006–10029 (2016).
192. Lipton, R. B. & Bigal, M. E. Migraine: Epidemiology, impact, and risk factors for progression. *Headache* **45**, S3–S13 (2005).
193. Dodick, D. W. Migraine. *The Lancet* **391**, 1315–1330 (2018).
194. Kelman, L. Pain characteristics of the acute migraine attack. *Headache* **46**, 942–953 (2006).
195. Silberstein, S. D. Migraine Symptoms: Results of a Survey of Self-Reported Migraineurs. *Headache J. Head Face Pain* **35**, 387–396 (1995).
196. Karsan, N., Prabhakar, P. & Goadsby, P. J. Characterising the premonitory stage of migraine in children: a clinic-based study of 100 patients in a specialist headache service. *J. Headache Pain* **17**, 1–7 (2016).
197. Giffin, N. J. *et al.* Premonitory symptoms in migraine: An electronic diary study. *Neurology* **60**, 935–940 (2003).
198. Lampl, C. *et al.* Interictal burden attributable to episodic headache: findings from the Eurolight project. *J. Headache Pain* **17**, 1–10 (2016).
199. Quintela, E., Castillo, J., Muñoz, P. & Pascual, J. Premonitory and resolution

- symptoms in migraine: A prospective study in 100 unselected patients. *Cephalalgia* **26**, 1051–1060 (2006).
200. Safiri S, Pourfathi H, Eagan A, Mansournia MA, Khodayari MT, Sullman MJM, Kaufman J, Collins G, Dai H, Bragazzi NL, K. A. Global, regional, and national burden of migraine in 204 countries and territories, 1990 to 2019. *Pain* (2021).
201. Kyu, H. H. *et al.* Global, regional, and national disability-adjusted life-years (DALYs) for 359 diseases and injuries and healthy life expectancy (HALE) for 195 countries and territories, 1990-2017: A systematic analysis for the Global Burden of Disease Study 2017. *Lancet* **392**, 1859–1922 (2018).
202. Buse, D. C. *et al.* Chronic migraine prevalence, disability, and sociodemographic factors: Results from the American migraine prevalence and prevention study. *Headache* **52**, 1456–1470 (2012).
203. Lipton, R. B. Tracing transformation: Chronic migraine classification, progression, and epidemiology. *Neurology* **72**, (2009).
204. Natoli, J. L. *et al.* Global prevalence of chronic migraine: A systematic review. *Cephalalgia* **30**, 599–609 (2010).
205. Marone, I. M. *et al.* TRPA1 / NOX in the soma of trigeminal ganglion neurons mediates migraine-related pain of glyceryl trinitrate in mice. *Brain* **141**, 2312–2328 (2018).
206. Nie, L., Jiang, L., Quinn, J. P., Grubb, B. D. & Wang, M. TRPA1-Mediated Src Family Kinases Activity Facilitates Cortical Spreading Depression Susceptibility and Trigeminovascular System Sensitization. *Int. J. Mol. Sci.* **22**, (2021).
207. Jiang, L., Ma, D., Grubb, B. D. & Wang, M. ROS/TRPA1/CGRP signaling mediates cortical spreading depression. *J. Headache Pain* **20**, (2019).
208. Jiang, L., Wang, Y., Xu, Y., Ma, D. & Wang, M. The Transient Receptor Potential Ankyrin Type 1 Plays a Critical Role in Cortical Spreading Depression. *Neuroscience* **382**, 23–34 (2018).
209. Awaki, E. & Takeshima, T. [Migraine Mechanisms: In Relation to the Premonitory Phase and CGRP/CGRP Receptor Antagonists]. *Brain and nerve* **73**, 303–313 (2021).
210. Zobdeh, F. *et al.* *Pharmacological treatment of migraine: Drug classes,*

- mechanisms of action, clinical trials and new treatments. British Journal of Pharmacology* **178**, 4588–4607 (John Wiley & Sons, Ltd, 2021).
211. Del Fiacco, M. *et al.* TRPV1, CGRP and SP in scalp arteries of patients suffering from chronic migraine. *J. Neurol. Neurosurg. Psychiatry* **86**, 393–397 (2015).
 212. Nassini, R. *et al.* The ‘headache tree’ via umbellulone and TRPA1 activates the trigeminovascular system. *Brain* **135**, 376–390 (2012).
 213. Koroleva, K. *et al.* Receptor mechanisms mediating the pro-nociceptive action of hydrogen sulfide in rat trigeminal neurons and meningeal afferents. *Front. Cell. Neurosci.* **11**, (2017).
 214. Demartini, C. *et al.* The role of the transient receptor potential ankyrin type-1 (TRPA1) channel in migraine pain: evaluation in an animal model. *J. Headache Pain* **18**, 94 (2017).
 215. Nassini, R., Materazzi, S., Benemei, S. & Geppetti, P. The TRPA1 channel in inflammatory and Neuropathic pain and migraine. *Rev. Physiol. Biochem. Pharmacol.* **167**, 1–44 (2014).
 216. Messlinger, K., Balczak, L. K. & Russo, A. F. Cross-talk signaling in the trigeminal ganglion: role of neuropeptides and other mediators. *Journal of Neural Transmission* **127**, 431–444 (2020).
 217. Dussor, G. & Cao, Y. Q. TRPM8 and Migraine. *Headache* **56**, 1406–1417 (2016).
 218. Chasman, D. I. *et al.* Genome-wide association study reveals three susceptibility loci for common migraine in the general population. in *Nature Genetics* **43**, 695–698 (Nat Genet, 2011).
 219. Kayama, Y. *et al.* Functional interactions between transient receptor potential M8 and transient receptor potential V1 in the trigeminal system: Relevance to migraine pathophysiology. *Cephalalgia* **38**, 833–845 (2018).
 220. Borhani-Haghighi, A. *et al.* Cutaneous application of menthol 10% solution as an abortive treatment of migraine without aura: A randomised, double-blind, placebo-controlled, crossed-over study. *Int. J. Clin. Pract.* **64**, 451–456 (2010).
 221. St. Cyr, A. *et al.* Efficacy and tolerability of STOPAIN for a migraine attack. *Front. Neurol.* **6**, (2015).
 222. Ucler, S., Coskun, O., Inan, L. E. & Kanatli, Y. Cold therapy in migraine patients:

- Open-label, non-controlled, pilot study. *Evidence-based Complement. Altern. Med.* **3**, 489–493 (2006).
223. Krause, D. N., Warfvinge, K., Haanes, K. A. & Edvinsson, L. Hormonal influences in migraine — interactions of oestrogen, oxytocin and CGRP. *Nat. Rev. Neurol.* **17**, 621–633 (2021).
224. Pringsheim T, Davenport W, Mackie G, Worthington I, Aubé M, Christie SN, Gladstone J, B. W. Canadian Headache Society guideline for migraine prophylaxis. *Can J Neurol Sci.* **39**, S1-59 (2012).
225. Leishman, E. *et al.* Environmental toxin acrolein alters levels of endogenous lipids, including TRP agonists: A potential mechanism for headache driven by TRPA1 activation. *Neurobiol. Pain* **1**, 28–36 (2017).
226. Olesen, J. *et al.* The International Classification of Headache Disorders, 3rd edition (beta version). *Cephalalgia* **33**, 629–808 (2013).
227. Cottrell, G. S. CGRP Receptor Signalling Pathways. doi:10.1007/164_2018_130
228. Buse, D. C. *et al.* Impact of Migraine on the Family: Perspectives of People with Migraine and Their Spouse/Domestic Partner in the CaMEO Study. *Mayo Clin. Proc.* **91**, 596–611 (2016).
229. Diener, H. C., Holle, D., Solbach, K. & Gaul, C. Medication-overuse headache: Risk factors, pathophysiology and management. *Nature Reviews Neurology* **12**, 575–583 (2016).
230. Ernstsén, C. *et al.* The PACAP pathway is independent of CGRP in mouse models of migraine: possible new drug target? *Brain* (2022). doi:10.1093/brain/awac040
231. Tso, A. R. & Goadsby, P. J. New targets for migraine therapy. *Curr. Treat. Options Neurol.* **16**, (2014).
232. Cairns, B. E. The influence of gender and sex steroids on craniofacial nociception. *Headache* **47**, 319–324 (2007).
233. Ornello, R. *et al.* Acute and preventive management of migraine during menstruation and menopause. *J. Clin. Med.* **10**, (2021).
234. Craft, R. M. Modulation of pain by estrogens. *Pain* **132**, S3 (2007).
235. Gupta, S. *et al.* Potential role of female sex hormones in the pathophysiology of migraine. *Pharmacology and Therapeutics* **113**, 321–340 (2007).

236. Aggarwal, M., Puri, V. & Puri, S. Effects of estrogen on the serotonergic system and calcitonin gene-related peptide in trigeminal ganglia of rats. *Ann. Neurosci.* **19**, 151–157 (2012).
237. Bi, R. Y. *et al.* Estradiol upregulates voltage-gated sodium channel 1.7 in trigeminal ganglion contributing to hyperalgesia of inflamed TMJ. *PLoS One* **12**, (2017).
238. Bi, R. Y., Zhang, X. Y., Zhang, P., Ding, Y. & Gan, Y. H. Progesterone Attenuates Allodynia of Inflamed Temporomandibular Joint through Modulating Voltage-Gated Sodium Channel 1.7 in Trigeminal Ganglion. *Pain Res. Manag.* **2020**, (2020).
239. Shields, L. B. E., Seifert, T., Shelton, B. J. & Plato, B. M. Testosterone levels in men with chronic migraine. *Neurol. Int.* **11**, 8079 (2019).
240. Gupta, S., McCarson, K. E., Welch, K. M. A. & Berman, N. E. J. Mechanisms of pain modulation by sex hormones in migraine. *Headache* **51**, 905–922 (2011).
241. Harriott, A. M., Strother, L. C., Vila-Pueyo, M. & Holland, P. R. Animal models of migraine and experimental techniques used to examine trigeminal sensory processing. *J. Headache Pain* **20**, (2019).
242. Pradhan, A. *et al.* Characterization of a novel model of chronic migraine. *Pain* **155**, 269–274 (2014).
243. Demartini, C. *et al.* Nitroglycerin as a comparative experimental model of migraine pain: From animal to human and back. *Prog. Neurobiol.* **177**, 15–32 (2019).
244. Louter, M. A. *et al.* Cutaneous allodynia as a predictor of migraine chronification. *Brain* **136**, 3489–3496 (2013).
245. Shiers, S. *et al.* Neuropathic pain creates an enduring prefrontal cortex dysfunction corrected by the type II diabetic drug metformin but not by gabapentin. *J. Neurosci.* **38**, 7337–7350 (2018).
246. Choi, J. C., Chung, M. I. & Lee, Y. D. Modulation of pain sensation by stress-related testosterone and cortisol. *Anaesthesia* **67**, 1146–1151 (2012).
247. Ulrich-Lai, Y. M. *et al.* Chronic stress induces adrenal hyperplasia and hypertrophy in a subregion-specific manner. *Am. J. Physiol. - Endocrinol. Metab.* **291**, 965–973 (2006).
248. Lee, L. Y., Hsu, C. C., Lin, Y. J., Lin, R. L. & Khosravi, M. Interaction between TRPA1

- and TRPV1: Synergy on pulmonary sensory nerves. *Pulm. Pharmacol. Ther.* **35**, 87–93 (2015).
249. Liu, B. *et al.* The acute nociceptive signals induced by bradykinin in rat sensory neurons are mediated by inhibition of M-type K⁺ channels and activation of Ca²⁺-activated Cl⁻ channels. *J. Clin. Invest.* **120**, 1240–1252 (2010).
250. De Logu, F. *et al.* Schwann cells expressing nociceptive channel TRPA1 orchestrate ethanol-evoked neuropathic pain in mice. *J. Clin. Invest.* **129**, 5424–5441 (2019).
251. Liu, C. *et al.* A Non-covalent Ligand Reveals Biased Agonism of the TRPA1 Ion Channel. *Neuron* **109**, 273–284 (2021).
252. Martínez-Rojas, V. A. *et al.* Peripheral and spinal TRPA1 channels contribute to formalin-induced long-lasting mechanical hypersensitivity. *J. Pain Res.* **11**, 51–60 (2018).
253. Giorgi, S., Nikolaeva-Koleva, M., Alarcón-Alarcón, D., Butrón, L. & González-Rodríguez, S. Is TRPA1 burning down TRPV1 as druggable target for the treatment of chronic pain? *International Journal of Molecular Sciences* **20**, 2906 (2019).
254. Gouin, O. *et al.* TRPV1 and TRPA1 in cutaneous neurogenic and chronic inflammation: pro-inflammatory response induced by their activation and their sensitization. *Protein and Cell* **8**, 644–661 (2017).
255. Ji, G., Zhou, S. & Carlton, S. M. Intact A δ -fibers up-regulate transient receptor potential A1 and contribute to cold hypersensitivity in neuropathic rats. *Neuroscience* **154**, 1054–1066 (2008).
256. Kunkler, P. E., Zhang, L., Pellman, J. J., Oxford, G. S. & Hurley, J. H. Sensitization of the trigeminovascular system following environmental irritant exposure. *Cephalalgia* **35**, 1192–1201 (2015).
257. R. Garrison, S. & L. Stucky, C. The Dynamic TRPA1 Channel: A Suitable Pharmacological Pain Target? *Curr. Pharm. Biotechnol.* **12**, 1689–1697 (2011).
258. Dunham, J. P., Kelly, S. & Donaldson, L. F. Inflammation reduces mechanical thresholds in a population of transient receptor potential channel A1-expressing nociceptors in the rat. *Eur. J. Neurosci.* **27**, 3151–3160 (2008).
259. Zimmermann, K. *et al.* Sensory neuron sodium channel Nav1.8 is essential for pain at low temperatures. *Nature* **447**, 855–858 (2007).

260. Zhao, J. *et al.* Small RNAs control sodium channel expression, nociceptor excitability, and pain thresholds. *J. Neurosci.* **30**, 10860–10871 (2010).
261. Viana, F., De la Peña, E. & Belmonte, C. Specificity of cold thermotransduction is determined by differential ionic channel expression. *Nat. Neurosci.* **5**, 254–260 (2002).
262. Camino, D. Del *et al.* TRPA1 contributes to cold hypersensitivity. *J. Neurosci.* **30**, 15165–15174 (2010).
263. Smith, C. A., Paskhover, B. & Mammis, A. Molecular mechanisms of trigeminal neuralgia: A systematic review. *Clin. Neurol. Neurosurg.* **200**, (2021).
264. Tanik, N., Saçmaci, H. & Aktürk, T. The relationship between exposure to hot/cold weather and the clinical features of headaches in patients with migraine and tension-type headaches. *Neurol. Res.* **42**, 239–243 (2020).
265. Bagherzadi, A., Emani, R., Ghavami, H., Khalkhali, H. R. & Ebrahimi, M. Comparing the Effect of Heat and Cold Therapy on the Intensity of Nitrate Induced Migraine Type Headache in Cardiac Inpatients: A Randomized Controlled Trial. *Agri* **33**, 148–154 (2021).
266. Pires, P. W. & Earley, S. Neuroprotective effects of trpa1 channels in the cerebral endothelium following ischemic stroke. *Elife* **7**, e35316 (2018).
267. Huang, D., Li, S., Dhaka, A., Story, G. M. G. M. & Cao, Y.-Q. Y. Q. Y.-Q. Expression of the transient receptor potential channels TRPV1, TRPA1 and TRPM8 in mouse trigeminal primary afferent neurons innervating the dura. *Mol. Pain* **8**, (2012).
268. Spahn, V., Stein, C. & Zöllner, C. Modulation of transient receptor vanilloid 1 activity by transient receptor potential ankyrin 1. *Mol. Pharmacol.* **85**, 335–344 (2014).
269. Nishizawa, Y., Takahashi, K., Oguma, N., Tominaga, M. & Ohta, T. Possible involvement of transient receptor potential ankyrin 1 in Ca²⁺ signaling via T-type Ca²⁺ channel in mouse sensory neurons. *J. Neurosci. Res.* **96**, 901–910 (2018).
270. Ponsati, B. *et al.* An inhibitor of neuronal exocytosis (DD04107) displays long-lasting in vivo activity against chronic inflammatory and neuropathic pain. *J. Pharmacol. Exp. Ther.* **341**, 634–645 (2012).
271. Charles, A. & Pozo-Rosich, P. Targeting calcitonin gene-related peptide: a new era

- in migraine therapy. *The Lancet* **394**, 1765–1774 (2019).
272. Zhang, X., Strassman, A. M., Novack, V., Brin, M. F. & Burstein, R. Extracranial injections of botulinum neurotoxin type A inhibit intracranial meningeal nociceptors' responses to stimulation of TRPV1 and TRPA1 channels: Are we getting closer to solving this puzzle? *Cephalalgia* **36**, 875–886 (2016).
273. Aydinlar, E. I., Yalinay Dikmen, P. & Sağduyu Kocaman, A. Botulinum Toxin in Migraine Treatment. *Noropsikiyatri Arsivi* **50**, 36–40 (2013).
274. Ren, L., Dhaka, A. & Cao, Y. Q. Function and postnatal changes of dural afferent fibers expressing TRPM8 channels. *Mol. Pain* **11**, 37 (2015).
275. Hilfiger, L. *et al.* Anti-Hyperalgesic Properties of Menthol and Pulegone. *Front. Pharmacol.* **12**, 753873 (2021).
276. Knowlton, W. *et al.* A sensory-labeled line for cold: TRPM8-expressing sensory neurons define the cellular basis for cold, cold pain, and cooling-mediated analgesia. *J. Neurosci.* **33**, 2837–2848 (2013).
277. Patel, R. *et al.* Anti-hyperalgesic effects of a novel TRPM8 agonist in neuropathic rats: A comparison with topical menthol. *Pain* **155**, 2097–2107 (2014).
278. Eccles, R. Menthol and Related Cooling Compounds. *Journal of Pharmacy and Pharmacology* **46**, 618–630 (1994).
279. Pergolizzi, J. V., Taylor, R., LeQuang, J. A. & Raffa, R. B. The role and mechanism of action of menthol in topical analgesic products. *J. Clin. Pharm. Ther.* **43**, 313–319 (2018).
280. Ashina, M. *et al.* Migraine: integrated approaches to clinical management and emerging treatments. *The Lancet* **397**, 1505–1518 (2021).
281. Weyer, A. D. & Lehto, S. G. Development of TRPM8 antagonists to treat chronic pain and migraine. *Pharmaceuticals* **10**, (2017).
282. Burgos-Vega, C. *et al.* Meningeal transient receptor potential channel M8 activation causes cutaneous facial and hindpaw allodynia in a preclinical rodent model of headache. *Cephalalgia* **36**, 185–193 (2016).
283. Horne, D. B. *et al.* Discovery of TRPM8 Antagonist (S)-6-(((3-Fluoro-4-(trifluoromethoxy)phenyl)(3-fluoropyridin-2-yl)methyl)carbonyl)nicotinic Acid (AMG 333), a Clinical Candidate for the Treatment of Migraine. *J. Med. Chem.* **61**,

- 8186–8201 (2018).
284. Ha, M. A. *et al.* Menthol attenuates respiratory irritation and elevates blood cotinine in cigarette smoke exposed mice. *PLoS One* **10**, (2015).
285. Willis, D. N., Liu, B., Ha, M. A., Jordt, S. & Morris, J. B. Menthol attenuates respiratory irritation responses to multiple cigarette smoke irritants. **25**, 4434–4444 (2011).
286. Fan, L. *et al.* Menthol decreases oral nicotine aversion in C57BL/6 mice through a TRPM8-dependent mechanism. *Tob. Control* **25**, ii50–ii54 (2016).
287. Liu, B. Y. *et al.* Menthol suppresses laryngeal C-fiber hypersensitivity to cigarette smoke in a rat model of gastroesophageal reflux disease: The role of TRPM8. *J. Appl. Physiol.* **118**, 635–645 (2015).
288. Greco, R. *et al.* Role of calcitonin gene-related peptide and substance P in different models of pain. *Cephalalgia* **28**, 114–126 (2008).
289. Liu, B. *et al.* TRPM8 is the principal mediator of menthol-induced analgesia of acute and inflammatory pain. *Pain* **154**, 2169–2177 (2013).
290. Shapovalov, G. *et al.* Opiates modulate thermosensation by internalizing cold receptor TRPM8. *Cell Rep.* **4**, 504–515 (2013).
291. Asuthkar, S., Velpula, K. K., Elustondo, P. A., Demirkhanyan, L. & Zakharian, E. TRPM8 channel as a novel molecular target in androgen-regulated prostate cancer cells. *Oncotarget* **6**, 17221–17236 (2015).
292. Yoo, H. S. & Napoli, J. L. Quantification of Dehydroepiandrosterone, 17 β -Estradiol, Testosterone, and Their Sulfates in Mouse Tissues by LC-MS/MS. *Anal. Chem.* **91**, 14624–14630 (2019).
293. Yin, Y. *et al.* Structural basis of cooling agent and lipid sensing by the cold-activated TRPM8 channel. *Science (80-.).* **363**, eaav9334 (2019).
294. Majeed, Y. *et al.* Pregnenolone sulphate-independent inhibition of TRPM3 channels by progesterone. *Cell Calcium* **51**, 1–11 (2012).
295. Lesnak, J. B., Inoue, S., Lima, L., Rasmussen, L. & Sluka, K. A. Testosterone protects against the development of widespread muscle pain in mice. *Pain* **161**, 2898–2908 (2020).
296. Fanton, L. E., Macedo, C. G., Torres-Chávez, K. E., Fischer, L. & Tambeli, C. H.

- Activational action of testosterone on androgen receptors protects males preventing temporomandibular joint pain. *Pharmacol. Biochem. Behav.* **152**, 30–35 (2017).
297. Ji, Y., Hu, B., Li, J. & Traub, R. J. Opposing Roles of Estradiol and Testosterone on Stress-Induced Visceral Hypersensitivity in Rats. *J. Pain* **19**, 764–776 (2018).
298. Carvalho, A. L. *et al.* TRPM8 modulates temperature regulation in a sex-dependent manner without affecting cold-induced bone loss. *PLoS One* **16**, e0231060 (2021).
299. Khosla, S. & Monroe, D. G. Regulation of bone metabolism by sex steroids. *Cold Spring Harbor Perspectives in Medicine* **8**, a031211 (2018).
300. Frye, C. A., Koonce, C. J., Edinger, K. L., Osborne, D. M. & Walf, A. A. Androgens with activity at estrogen receptor beta have anxiolytic and cognitive-enhancing effects in male rats and mice. *Horm. Behav.* **54**, 726–734 (2008).
301. Bianchi, V. E. *et al.* The role of androgens in women’s health and wellbeing. *Pharmacological Research* **171**, 105758 (2021).
302. Wehbeh, L., Dobs, A. S. & Brown, T. T. Hypogonadism in opioid using males in an inner-city cohort: A cross-sectional study. *J. Opioid Manag.* **17**, 135–144 (2021).
303. Taylor, N. E. *et al.* The rostromedial tegmental nucleus: A key modulator of pain and opioid analgesia. *Pain* **160**, 2524–2534 (2019).
304. Ferrari, L. F. *et al.* D2 Receptors in the Periaqueductal Gray/Dorsal Raphe Modulate Peripheral Inflammatory Hyperalgesia via the Rostral Ventral Medulla. *Neuroscience* **463**, 159–173 (2021).
305. Elsenbruch, S. Abdominal pain in Irritable Bowel Syndrome: a review of putative psychological, neural and neuro-immune mechanisms. *Brain. Behav. Immun.* **25**, 386–394 (2011).
306. Hankerd, K. *et al.* Postinjury stimulation triggers a transition to nociplastic pain in mice. *Pain* (2021).
307. Pergolizzi, J. V, Taylor, R., LeQuang, J. A. & Raffa, R. B. The role and mechanism of action of menthol in topical analgesic products. *Journal of Clinical Pharmacy and Therapeutics* **43**, 313–319 (2018).
308. Truett, G. E. *et al.* Preparation of PCR-quality mouse genomic dna with hot sodium

- hydroxide and tris (HotSHOT). *Biotechniques* **29**, 52–54 (2000).
309. Moye, L. S. & Pradhan, A. A. A. Animal model of chronic migraine-associated pain. *Curr. Protoc. Neurosci.* **2017**, 9.60.1-9.60.9 (2017).
 310. Iversen, H. K. Experimental Headache in Humans. *Cephalalgia* **15**, 281–287 (1995).
 311. Iversen, H. K. Human migraine models. *Cephalalgia* **21**, 781–785 (2001).
 312. Chaplan, S. R., Bach, F. W., Pogrel, J. W., Chung, J. M. & Yaksh, T. L. Quantitative assessment of tactile allodynia in the rat paw. *J. Neurosci. Methods* **53**, 55–63 (1994).
 313. Idris, A. I. Ovariectomy/orchidectomy in rodents. *Methods Mol. Biol.* **816**, 545–551 (2012).
 314. Zhao, R. *et al.* A GPR174–CCL21 module imparts sexual dimorphism to humoral immunity. *Nature* **577**, 416–420 (2020).
 315. Nilsson, M. E. *et al.* Measurement of a Comprehensive Sex Steroid Profile in Rodent Serum by High-Sensitive Gas Chromatography-Tandem Mass Spectrometry. *Endocrinology* **156**, 2492–2502 (2015).
 316. Zenclussen, M. L., Casalis, P. A., Jensen, F., Woidacki, K. & Zenclussen, A. C. Hormonal fluctuations during the estrous cycle modulate heme oxygenase-1 expression in the uterus. *Front. Endocrinol. (Lausanne)*. **5**, 32 (2014).
 317. Chomzynski, P. Single-Step Method of RNA Isolation by Acid Guanidinium Thiocyanate–Phenol–Chloroform Extraction. *Anal. Biochem.* **162**, 156–159 (1987).

ANEXO

TRPM8 contributes to sex dimorphism by promoting recovery of normal sensitivity in a mouse model of chronic migraine

Received: 8 October 2021

Accepted: 30 September 2022

Published online: 22 October 2022

 Check for updates

David Alarcón-Alarcón^{1,2}, David Cabañero ^{1,2} ✉, Jorge de Andrés-López ¹,
Magdalena Nikolaeva-Koleva ¹, Simona Giorgi ¹,
Gregorio Fernández-Ballester ¹, Asia Fernández-Carvajal ^{1,3} ✉ &
Antonio Ferrer-Montiel ^{1,3} ✉

TRPA1 and TRPM8 are transient receptor potential channels expressed in trigeminal neurons that are related to pathophysiology in migraine models. Here we use a mouse model of nitroglycerine-induced chronic migraine that displays a sexually dimorphic phenotype, characterized by mechanical hypersensitivity that develops in males and females, and is persistent up to day 20 in female mice, but disappears by day 18 in male mice. TRPA1 is required for development of hypersensitivity in males and females, whereas TRPM8 contributes to the faster recovery from hypersensitivity in males. TRPM8-mediated antinociception effects required the presence of endogenous testosterone in males. Administration of exogenous testosterone to females and orchidectomized males led to recovery from hypersensitivity. Calcium imaging and electrophysiological recordings in *in vitro* systems confirmed testosterone activity on murine and human TRPM8, independent of androgen receptor expression. Our findings suggest a protective function of TRPM8 in shortening the time frame of hypersensitivity in a mouse model of migraine.

Chronic migraine is a highly prevalent and recurrent headache affliction particularly severe in women¹. While considerable advances have been made in the understanding of the disease^{2,3}, the mechanisms underlying the sex dimorphism of chronic migraine remain largely unknown. A migraine model with high predictive validity is the sensory sensitization induced by nitroglycerin (NTG)⁴. Acute NTG treatments lead to a delayed hypersensitivity to mechanical stimulation that lasts hours in humans and rodents^{4,5}. Furthermore, repeated NTG exposure causes a chronic hypersensitivity that lasts several weeks in murine models⁶. This chronic hypersensitivity is characterized by generalized cutaneous sensitization, which has also been described as a reliable predictor of migraine chronification in humans^{7,8} that is found more prevalently in women^{9,10}.

Multiple migraine triggers including NTG have demonstrated a crucial involvement of transient receptor potential ankyrin 1 (TRPA1) in rodent models of acute migraine^{5,11}. In these acute models, NTG acts as a donor of nitric oxide triggering a TRPA1-mediated neuronal activity that promotes nociceptive hypersensitivity⁵. Indeed, TRPA1 is expressed in primary afferent neurons innervating the meninges where its activation favors the release of α -calcitonin gene-related peptide (α CGRP)^{11,12}, a neuropeptide that plays a pivotal role in migraine development^{4,13,14}. Thus, TRPA1 antagonists reduce meningeal inflammation and hypernociception in basic pain models^{2,15} and α CGRP inhibition constitutes an effective strategy for migraine treatment in humans³. Although recent reports have described higher contribution of α CGRP in females¹⁶, the involvement of TRPA1 in males and females has not been yet studied in preclinical models of chronic migraine.

¹Instituto de Investigación, Desarrollo e Innovación en Biotecnología Sanitaria de Elche (IDiBE), Universidad Miguel Hernández de Elche, Elche, Spain.

²These authors contributed equally: David Alarcón-Alarcón, David Cabañero. ³These authors jointly supervised this work: Asia Fernández-Carvajal, Antonio Ferrer-Montiel. ✉e-mail: dcabanero@umh.es; asia.fernandez@umh.es; aferrer@umh.es

An additional TRP channel tightly associated with the expression of chronic migraine in humans is the transient receptor potential melastatin 8 (TRPM8). Several single-nucleotide polymorphisms affecting TRPM8 have been linked to chronic migraine and allodynia^{17,18}. Concurrently, TRPM8 agonists such as menthol have been used medicinally for the alleviation of migraine-related^{19,20} and TRPA1-associated pain²¹. TRPM8 is a cation channel expressed in primary afferent neurons, known for being the menthol receptor and the principal detector of environmental cold^{22–24}. As such, TRPM8 activity shows modulatory effects on thermal and mechanical hypersensitivity in preclinical models of pain²⁵. However, its presence in internal structures kept at euthermic temperature²⁶ and its recent description in central brain areas²⁷ suggest additional functions of this protein that may go beyond cold perception. In this line, TRPM8 was previously described as a testosterone receptor in cellular models²⁸. While high testosterone levels have been associated with decreased nociceptive sensitivity in mice^{29,30} and humans³¹, it is unknown whether testosterone-TRPM8 interactions could have functional relevance in nociception.

Here we implemented a murine model of chronic migraine that displays a sexual dimorphism characterized by enhanced nociceptive sensitivity of females as described in humans³. The aim of the study was to investigate the involvement of TRPA1 and TRPM8 in this sexually dimorphic behavior. To address this, mechanical sensitivity was assessed in mice of both sexes chronically exposed to NTG and the participation of TRPA1 and TRPM8 was evaluated through genetic and pharmacological approaches. To dissect the functional and molecular consequences of TRPA1 and TRPM8 activities, murine cultures of trigeminal neurons and transfected cell lines expressing murine and human receptors were evaluated through calcium imaging. After finding a male-specific function of TRPM8, the role of testosterone-TRPM8 interactions and the effects of exogenous TRPM8 stimulation were elucidated in *in vitro* and *in vivo* models of acute and chronic pain. Molecular docking in human ligand-receptor models may provide further insight on testosterone activity through TRPM8 and the effects of this interaction were corroborated through electrophysiological recordings that show independency of androgen receptor expression. Collectively, our data suggest that testosterone, through its interaction with TRPM8, drives sexual dimorphism in the model of chronic migraine and likely in other pain-related behaviors.

Results

Repeated NTG treatment induces a persistent mechanical hypersensitivity that remains up to 20 days in female mice but disappears in male mice

We implemented in our laboratory a modification of a previous model of chronic migraine induced by repeated NTG treatment⁶. NTG (10 mg/kg) or vehicle (5% dextrose and 0.105% propylene glycol in water) were administered intraperitoneally (*i.p.*) every other day during 8 days to male and female mice, and mechanical sensitivity was assessed before and after each treatment and for 12 additional days after the end of the repeated administrations (Fig. 1a). Two hours after each NTG treatment, acute hypersensitivity was observed in male and female mice, whereas the vehicle did not induce nociceptive sensitization (Fig. 1b, left panel, $p < 0.001$ treatment effect). Mechanical sensitivity assessed before NTG injections and after the end of the repeated treatment (up to 20 days after beginning of the treatments, right panel of Fig. 1b) showed a long-lasting hypersensitivity in male mice (days 2–16, $p < 0.05$ vs. baseline and vehicle, Fig. 1b) that returned to baseline values 8 days after the last NTG injection (day 18, Fig. 1b, nonsignificant vs. baseline or vs. vehicle). In contrast, female mice presented a persistent cutaneous hypernociception that was significant until the end of the experimental procedure ($p < 0.05$ vs. baseline, vs. vehicle, Fig. 1b). Thus, data obtained in this observation period indicate a sexual dimorphism as males can fully recover from NTG sensitization, while females improve partially.

Repeated NTG treatment induces long-lasting TRPA1-dependent hypersensitivity in female and male mice

Migraine-related nociception produced by acute NTG treatment has been associated to TRPA1 activity in trigeminal ganglia of male mice⁵. We investigated the possible participation of TRPA1 on the model of chronic migraine. Wild-type and TRPA1 knockout mice received NTG injections and mechanical sensitivity was assessed (Fig. 2a). As expected, wild-type mice showed acute hypersensitivity 2 h after each NTG injection. On the contrary, this sensitization was absent in TRPA1 knockout mice of both sexes (Fig. 2a, $p < 0.001$ genotype effect, left panels), in agreement with a previous study describing lack of acute NTG sensitization in TRPA1 knockout males⁵. TRPA1 deletion also prevented the development of chronic hypersensitivity in males and females (Fig. 2a, right panels).

To understand the role of TRPA1 in mediating NTG-induced sensitization in mice, we assessed TRPA1 mRNA expression and intracellular calcium imaging in trigeminal ganglia of male and female mice chronically exposed to NTG (Fig. 2b, c). Samples from NTG-treated wild-type animals showed an increased TRPA1 mRNA expression regardless of the sex (Fig. 2b, $p < 0.001$ vs. vehicle). In parallel, trigeminal neuronal cultures of male and female mice revealed calcium transients in response to the TRPA1 agonist allyl isothiocyanate (AITC) at 70 μ M (Fig. 2c). These responses were of similar magnitude in samples of both sexes and had higher amplitude in neurons of mice chronically exposed to NTG ($p < 0.01$ vs. vehicle, Fig. 2d). These results obtained with non-ratiometric calcium imaging were obtained by normalization of AITC-induced transients to 40 mM KCl responses which were similar in vehicle and NTG-treated mice. The neuronal population responding to AITC was composed of small to medium size neurons (100–700 μ m², Supplementary Fig. 2a). This increased TRPA1 responsiveness was also characterized by a higher percentage of cells showing significant activity (percentage of KCl-sensitive cells, $p < 0.001$ vs. vehicle, Supplementary Fig. 2b), and the size of these responses was proportional to the percentage of sensitive cells (Supplementary Fig. 2c). Thus, the trigeminal cultures revealed small to medium size neurons with increased TRPA1 activity after chronic NTG treatment, regardless of the sex.

To further investigate TRPA1 involvement on NTG sensitization, trigeminal neurons of naïve wild-type and TRPA1 knockout mice were cultured to assess calcium responses. These neurons were challenged with 100 μ M NTG followed by 70 μ M AITC (Fig. 2e). A 15.7 \pm 3.2% of the cells responded to both stimuli in wild-type mice, while this percentage decreased drastically in TRPA1 knockouts (0.6 \pm 0.3%, $p < 0.001$, Fig. 2f), revealing an essential participation of TRPA1 in calcium transients elicited by both NTG and AITC in mice. To assess the translatability of this NTG activity to human TRPA1, NTG was applied to human TRPA1-transfected HEK293 cells and IMR90 fibroblast cells natively expressing this receptor (Fig. 2g). Both cell types showed a dose-dependent relationship for NTG-evoked calcium influx, whereas control HEK293 cells did not respond. Thus, NTG activated both human and murine TRPA1 channels.

TRPA1-mediated trigeminal sensitization may involve the release of the vasodilator peptide α CGRP^{11,12}. This neuropeptide is an essential neurotransmitter for migraine neuroinflammation and pain¹³. Hence, we next examined NTG-induced α CGRP release in cultured trigeminal neurons through α CGRP immunofluorescence. A treatment with DD04107, an exocytosis inhibitor that interacts with the exocytosis-related protein SNAP-25³² was used to investigate vesicular release. Control neurons exposed to NTG vehicle showed stronger α CGRP immunoreactivity than NTG-treated neurons (Fig. 2h, i, $p < 0.001$) suggesting vesicular α CGRP release after NTG. In contrast, neurons pre-treated with DD04107 showed significantly higher α CGRP

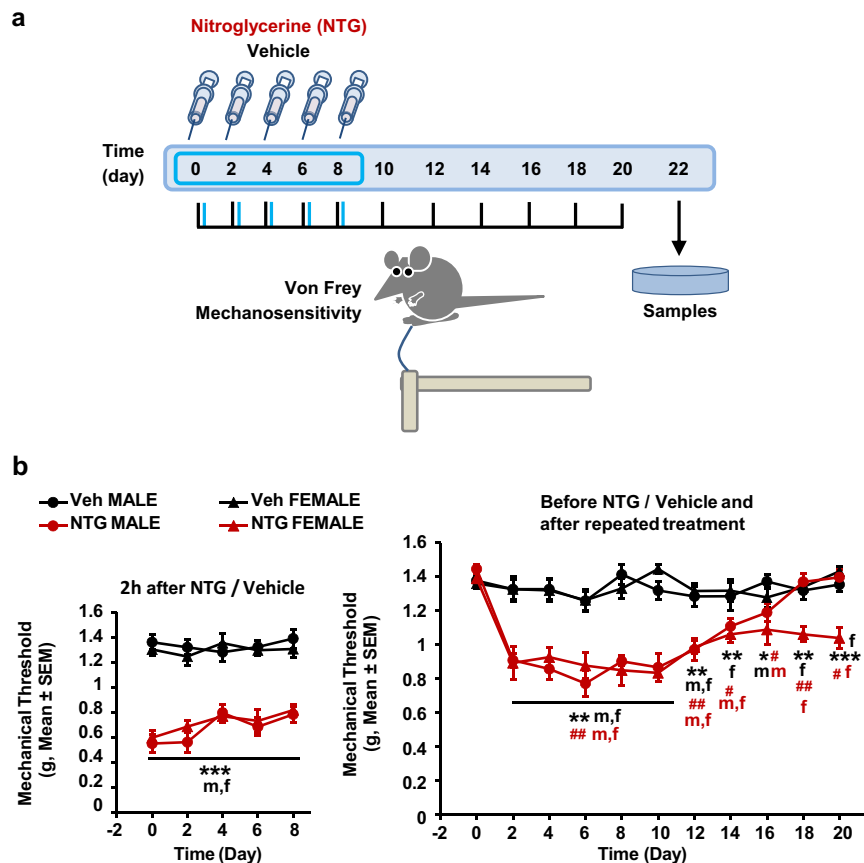

Fig. 1 | Chronic nitroglycerin administration induces generalized long-lasting mechanical hypersensitivity in male and female mice. **a** Model of chronic migraine induced by five intraperitoneal injections of 10 mg/kg nitroglycerin or its vehicle administered every other day (days 0, 2, 4, 6 and 8). Hind paw mechanical sensitivity was assessed with von Frey filaments 2 h after nitroglycerin administration (blue lines), before nitroglycerin injections and after the end of the treatments on days 10, 12, 14, 16, 18 and 20 (black lines). Tissue samples were obtained at the end. **b** Left panels. Nitroglycerin (red) induces similar acute hypersensitivity in males

and females, whereas the vehicle (black, 5% dextrose, 0.105% propylene glycol) did not induce nociceptive sensitization. **b** Right panels. Chronic administration of nitroglycerin induces a long-lasting hypersensitivity that is persistent exclusively in females, whereas female or male mice treated with vehicle show normal sensitivity. Data are mean \pm S.E.M. ** $p < 0.01$, *** $p < 0.001$ vs. vehicle. # $p < 0.05$, ## $p < 0.01$, ### $p < 0.001$ vs. baseline. Two-way RM ANOVA $n = 6$ mice per each vehicle group, $n = 7$ mice per each NTG group. NTG nitroglycerin, Veh Vehicle. Source data provided in the Source Data file, statistical results in Supplementary Table 1.

immunoreactivity (Fig. 2i, $p < 0.01$ vs. NTG + vehicle), indicating inhibition of the neuropeptide release after NTG. Collectively, these data indicate that TRPA1 activity was essential for acute and chronic NTG hypersensitivity, although it could not explain the observed sexual dimorphism.

TRPM8 activity determines the recovery of normal sensitivity in male mice exposed to the model of chronic migraine

TRPM8 is a thermoTRP channel that has been signaled in the pathophysiology of chronic migraine. Thus, we next investigated the involvement of TRPM8 in NTG chronic sensitization. For this purpose, male and female wild-type and TRPM8 knockout mice were exposed to the chronic NTG treatment (Fig. 3a). Wild-type males presented the expected sensitization (Fig. 3a, $p < 0.01$ vs. Baseline on days 8 and 15) that was resolved by the end of the experimental procedure (day 20, Fig. 3a). Noteworthy, TRPM8 knockout males maintained a persistent sensitization that was significant until the last day of measurements, akin to the persistent sensitization observed in females ($p < 0.01$ vs. Baseline and wild-type, Right panel of Fig. 3a). This finding revealed a protective function of TRPM8 in males subjected to NTG-mediated chronic sensitization and signaled a potential role of this channel in sex dimorphism in the model of chronic migraine.

To investigate the involvement of TRPM8 in sex dimorphism, we next analyzed its expression in trigeminal ganglia of male and

female wild-type mice chronically exposed to NTG. TRPM8 mRNA values were similar regardless of treatment and sex (Fig. 3b). Functionally, perfusion with the selective and potent TRPM8 agonist WS12 (500 nM) elicited calcium transients of similar amplitude in both sexes, after chronic vehicle or NTG (Fig. 3c, d). WS12 activated $8 \pm 2.1\%$ of the cultured neurons (Supplementary Fig. 3a), which were small size cells ($50\text{--}400 \mu\text{m}^2$, Supplementary Fig. 3b, c). This percentage was similar in samples of vehicle and NTG-treated mice. Hence, trigeminal cultures showed that TRPM8 activity and expression were similar between sexes and after the NTG treatment.

Given this similar functionality, we conducted additional experiments to test the antinociceptive efficacy of WS12 in wild-type female mice sensitized after chronic NTG. On day 20, females received WS12 or its vehicle. The observed responses were highly variable and nonsignificant results were found after 10 mg/kg WS12 (i.p.), a dose with reported antinociceptive efficacy in male mice³³ (Fig. 3e). In a separate experiment, we tested the effect of lower (5 mg/kg, Supplementary Fig. 4a) and higher doses of WS12 (20 mg/kg, Supplementary Fig. 4b) in wild-type and TRPM8 knockout females. Both the highest dose (Supplementary Fig. 4b, $p = 0.053$ vs. vehicle), and the lowest dose were ineffective. WS12 showed efficacy when administered in a vehicle containing 5% ethanol and 45% cyclodextrin, however possible antinociceptive effects of this vehicle were detected (Supplementary Fig. 4c). To further characterize the

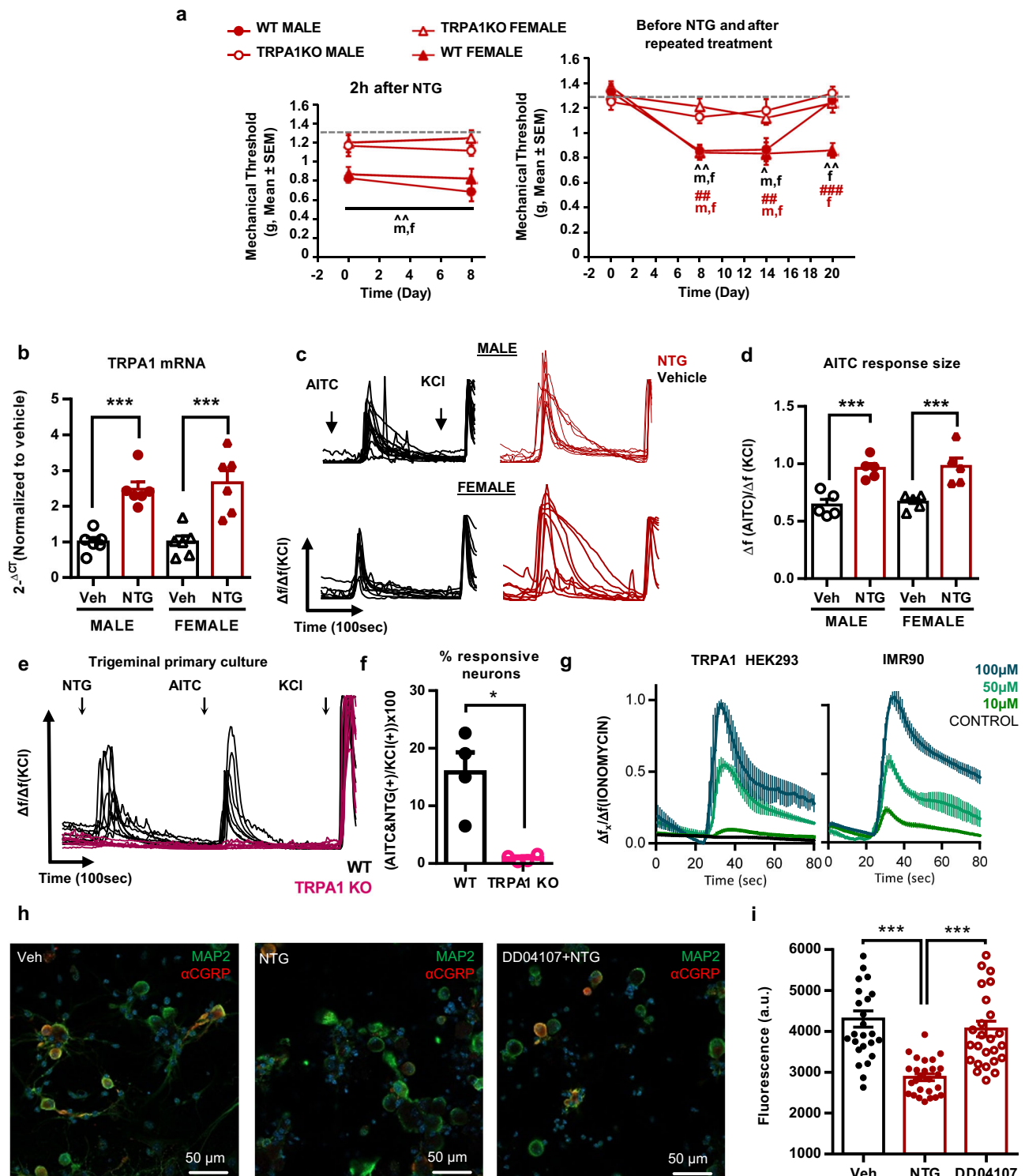

in vivo activity of WS12 in females, we decided to examine the antinociceptive effect of TRPM8 activity on the formalin pain model, another TRPA1-dependent pain model³⁴. As illustrated in Fig. 3f, WS12 induced significant antinociception in the acute phase, whereas the late phase was unaltered, revealing a short-lasting effect of this compound.

To further investigate the function of TRPM8 in wild-type males, mice previously exposed to NTG that had recovered their baseline sensitivity were exposed to increasing doses of the TRPM8 blocker AMTB (Fig. 3g). This compound precipitated a significant re-sensitization when administered at 10 or 15 mg/kg

($p < 0.05$ vs. vehicle, Fig. 3g) in this model. Interestingly, similar results were obtained in male mice previously subjected to the formalin test. To corroborate the existence of a TRPM8-dependent tone in males providing relief after TRPA1-induced nociception, male mice were treated with AMTB after the extinction of formalin-induced nocifensive activity. These mice showed a significant reinstatement of licking behavior evident 30 min after administration of the compound ($p < 0.05$ vs. vehicle, Fig. 3h). Altogether, these results suggest the presence of endogenous TRPM8 activity with antinociceptive function in male mice.

Fig. 2 | TRPA1-related activity is essential for mechanical hypersensitivity after nitroglycerin and TRPA1 expression and function increase in trigeminal ganglia of chronically exposed males and females.

a TRPA1 deletion prevents acute and chronic mechanical hypersensitivity after nitroglycerin in male and female mice. **b** Trigeminal ganglia of male and female mice show increased TRPA1 mRNA expression after chronic nitroglycerin exposure. **c** Representative calcium traces in response to 70 μ M AITC normalized to 40 mM KCl in trigeminal cells of mice chronically exposed to vehicle or nitroglycerin. **d** AITC responses increase in trigeminal cultures from nitroglycerin-treated animals regardless of the sex. Average response size of AITC-sensitive neurons vs. KCl responses. **e** Wild-type trigeminal neurons responding to 100 μ M nitroglycerin also respond to 70 μ M AITC. TRPA1 knockout mice lack these responses. **f** 15% of trigeminal neurons respond to AITC and NTG in wild-type mice vs. 1–2% in TRPA1 knockouts. **g** TRPA1-transfected HEK293 cells and IMR90 cells constitutively expressing hTRPA1 show calcium responses after 10, 50 and 100 μ M nitroglycerin. **h** Trigeminal culture exposed to vehicle, nitroglycerin or the exocytosis inhibitor DD04107. Cells labeled with pan-

neuronal marker antiMAP2 (green), anti α CGRP (red) and nuclei marked with DAPI (blue). **i** Nitroglycerin decreases intracellular α CGRP immunoreactivity and DD04107 prevents this. Mean mechanical thresholds (**a**), expression (**b**), calcium response (**d**, **f**) or red fluorescence (**i**) \pm S.E.M. Datapoints without error bars represent values of individual animals, except for **i** where dots represent quantified images. **a** $^{\wedge}p < 0.05$, $^{\wedge\wedge}p < 0.01$, $^{\wedge\wedge\wedge}p < 0.001$ vs. vehicle. $^{\#}p < 0.05$, $^{\#\#\#}p < 0.01$ vs. baseline, two-way RM ANOVA, $n = 6$ mice per condition except for WT female group which was of five mice; **b** $^{\wedge\wedge\wedge}p < 0.001$ two-way ANOVA, $n = 6$ samples from six different mice per condition, obtained after one behavioral experiment; **d** $^{\wedge\wedge\wedge}p < 0.001$ two-way ANOVA, $n = 5$ samples from five different mice per condition, obtained in three independent experiments; **f** $^{\#}p < 0.05$ two-sided Mann–Whitney U $n = 5$ samples from five different mice per condition, obtained in three independent experiments; **i** $^{\wedge\wedge\wedge}p < 0.001$, one-way ANOVA $n = 26$ images from samples of five mice per condition, obtained in five independent experiments. NTG nitroglycerin, Veh vehicle. Source data are provided in Source Data file, statistical results in Supplementary Table 2.

Testosterone activates TRPM8 to resolve mechanical sensitization in mice exposed to the model of chronic migraine

Testosterone has been suggested as an endogenous TRPM8 agonist²⁸ and shows antinociceptive functions in mice²⁹. We hypothesized that this endogenous androgen could have a protective function in the mouse model of chronic migraine. To address this question, mice were first subjected to a sham surgery or to an orchidectomy to deplete gonadal testosterone. Once their nociceptive sensitivity was restored the animals received the NTG treatment (Fig. 4a). Acute NTG produced similar hypernociception in sham and orchidectomized animals (Fig. 4a, left panel, $p < 0.001$ vs. vehicle). In contrast, the repeated NTG evidenced a persistent chronic sensitization selectively expressed in orchidectomized animals (Fig. 4a, right panel, $p < 0.01$ vs. sham), indicating possible protective role of testosterone.

To investigate whether testosterone could have TRPM8-mediated antinociceptive effect in males, wild-type and TRPM8 knockout males were orchidectomized and received subcutaneous osmotic pumps filled with testosterone or its vehicle (cyclodextrin 45% in water). Afterwards, all mice were chronically treated with NTG, and their mechanical sensitivity was assessed. Testosterone induced complete recovery of mechanical thresholds in wild-type mice (Fig. 4b, right panel, day 20, $p < 0.001$ vs. Vehicle wild-type, nonsignificant vs. baseline), while vehicle-treated animals remained sensitized by the end of the experiment (Fig. 4b, right pane, $p < 0.001$ vs. baseline on day 20). In contrast, TRPM8 knockout mice lacked this restorative effect of testosterone (Fig. 4b, right panel, day 20, $p < 0.001$ vs. wild-type, $p < 0.001$ vs. baseline), although an antinociceptive effect independent of TRPM8 activity was also evidenced in knockouts (Fig. 4b, right panel, day 20, $p < 0.05$ vs. vehicle TRPM8 knockout). To further clarify the involvement TRPM8 in the protective effect of testosterone, AMTB was administered to all mice after the nociceptive measurement on day 20 (Fig. 4c). A significant drop in the mechanical thresholds was selectively observed in wild-type animals treated with testosterone (Fig. 4c, $p < 0.01$ vs. values before AMTB), whereas mice receiving vehicle and knockouts showed unaltered mechanosensitivity. These results revealed significant testosterone-TRPM8 antinociception in males.

Next, to determine whether testosterone could have rapid antinociceptive effects we treated NTG-exposed wild-type and TRPM8 knockout females with a single subcutaneous administration of 1 mg/kg testosterone or its vehicle (2.5% DMSO in corn oil, Fig. 4d). A significant testosterone-induced antinociception was observed selectively in wild-type mice ($p < 0.05$ vs. pre-treatment values, $p < 0.05$ vs. testosterone-treated TRPM8 knockouts). Overall, the present behavioral results suggest nongenomic antinociceptive effects of testosterone through TRPM8.

We next investigated if testosterone activated TRPM8 channels in trigeminal cultures as a mechanism to account for the protective role

of the androgen. Trigeminal cultures of wild-type mice showed calcium transients in response to 10 pM testosterone (Fig. 4e). Cells responding to testosterone also presented calcium transients in response to 500 nM WS12 ($7.9 \pm 0.8\%$ of KCl-sensitive cells; Fig. 4e). These responses were abolished in neural cultures from TRPM8 knockout animals tested side-by-side (Fig. 4e, $p < 0.001$ vs. wild-type), revealing a testosterone activity through TRPM8 in trigeminal neurons. Previous studies described structural and functional differences between murine and human TRPM8³⁵. To evaluate this possibility, we assessed testosterone activity on HEK293 cells constitutively expressing murine or human TRPM8 (Fig. 4f). Similar calcium transients were elicited after testosterone 10 pM in cells expressing human or murine TRPM8, whereas control HEK293 cells lacked this response (Fig. 4f). Altogether, the present data reveal a testosterone activity on murine and human TRPM8.

Testosterone-induced current of human TRPM8 is independent of androgen receptor expression

Given the possible interaction of testosterone with TRPM8, we conducted patch-clamp whole-cell recordings to assess possible testosterone-induced currents on HEK293 cells heterologously expressing human TRPM8 (hTRPM8-HEK293). Current density (pA/pF) vs. voltage relationships in these cells (Fig. 5a) evidenced an increase in outward rectifying current after 10 s application of 10 pM testosterone. This testosterone-induced current was significantly different from the basal current (Fig. 5b, $p < 0.05$) and was completely blocked in the presence of 10 μ M AMTB, the specific TRPM8 blocker (Fig. 5b, $p < 0.01$ vs. 10 pM testosterone). As testosterone's primary mechanism of action is through binding to the androgen receptor (AR), an additional experiment was conducted knocking down the androgen receptor in hTRPM8-HEK293 cells. Thus, hTRPM8-HEK293 cells were transfected with small interfering RNA (siRNA) targeting the AR or with scrambled siRNA. In parallel, wild-type HEK293 cells lacking heterologous expression of TRPM8 were assayed (WT HEK293). hTRPM8-HEK293 cells transfected with either anti-AR siRNA or scrambled siRNA showed similar current density-voltage curves after 10 pM testosterone (Fig. 5c), whereas WT HEK293 cells did not display testosterone-induced currents ($p < 0.01$ WT HEK293 vs. hTRPM8-HEK293, current fold increase at +80 mV, Fig. 5d). To ensure the silencing of AR expression, western blot was performed in samples of hTRPM8-HEK293 and WT HEK293 cells cultured in parallel to the cells used for electrophysiological recordings (Fig. 5e). A disruption of AR expression was confirmed in hTRPM8-HEK293 cells treated with anti-AR siRNA, whereas hTRPM8-HEK293 cells treated with scrambled siRNA or WT HEK293 cells presented evident AR expression. In order to allow the comparison to an established TRPM8 agonist in the same setting, we conducted dose-response curves for testosterone and WS12 in untreated hTRPM8-HEK293 cells, obtaining EC50s of 7 pM for

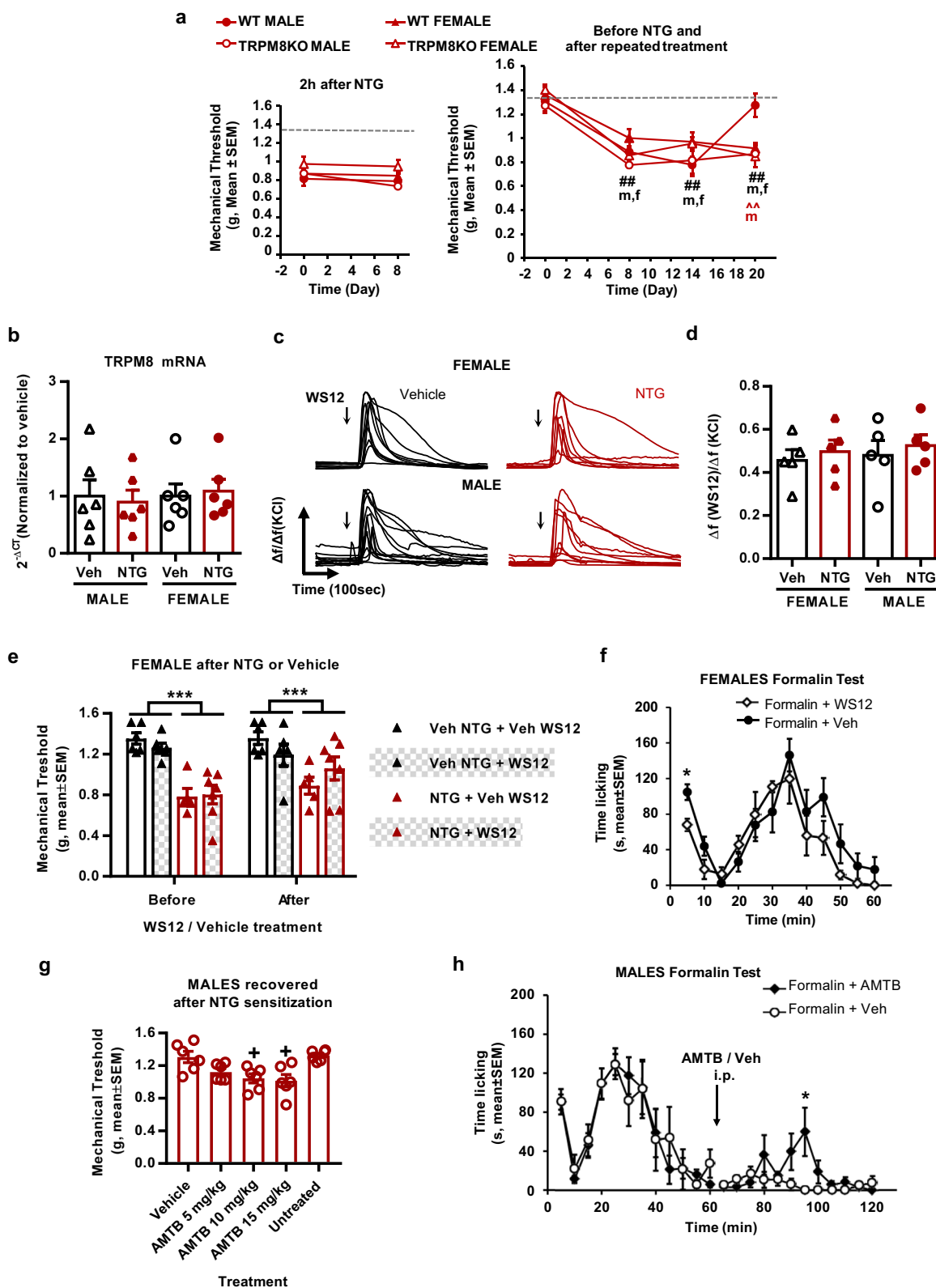

testosterone and 500 nM for WS12 (Supplementary Fig. 5a). The EC₅₀ of WS12 was afterwards used to estimate the IC₅₀ of the TRPM8 antagonist AMTB, which also binds to the menthol-binding site³⁶ (Supplementary Fig. 5b). Subsequent application of AMTB IC₅₀ (15 nM) shifted the testosterone dose-response curve to the right (Fig. 5f, EC₅₀ = 34 pM), being compatible with competitive inhibition. Hence, testosterone-induced currents were selectively elicited in

HEK293 cells heterologously expressing human TRPM8, were independent of AR expression and sensitive to the TRPM8 antagonist AMTB, substantiating an ionotropic action of the hormone²⁸.

Discussion

The most salient contribution of our study is the discovery of the role of TRPM8 as an androgen-activated receptor that provides

Fig. 3 | TRPM8 allows recovery of normal sensitivity in male mice exposed to nitroglycerin or formalin. **a** Wild-type and TRPM8 knockout males display similar acute mechanical hypersensitivity after nitroglycerin (left panel). Deletion of this receptor prevents recovery of baseline mechanical sensitivity after chronic nitroglycerin treatment in males (right). Acute and long-lasting hypersensitivity is similar in wild-type and knockout females. **b** Trigeminal TRPM8 mRNA expression is similar regardless of sex or nitroglycerin/vehicle treatment. **c** Calcium responses of trigeminal cultures from males and females chronically exposed to nitroglycerin or vehicle after exposure to TRPM8 agonist WS12 (500 nM). **d** Average size of calcium transients after WS12 is similar in neurons from males and females. Response sizes vs. respective KCl responses. **e** Female mice chronically exposed to nitroglycerin show increased mechanical sensitivity when compared to vehicle-treated mice. This sensitivity remained unchanged after 10 mg/kg WS12 i.p. **f** Nocifensive behavior in the acute phase of the formalin test (5 min) is significantly alleviated in females receiving 6 nmol WS12 i.p. **g** TRPM8 antagonist AMTB (i.p.) unmasks latent mechanical pain sensitization in mice chronically exposed to nitroglycerin that

already recovered their basal sensitivity. **h** 10 mg/kg AMTB administered 1 h after formalin injections induces significant reinstatement of licking behavior in males. Mean mechanical thresholds (**a, e, g**), expression (**b**), response size (**d**), nocifensive behavior (**f, h**) \pm S.E.M. Datapoints without error bars represent values of individual animals. **a** $\#\#p < 0.01$ vs. baseline. $\sim p < 0.01$ vs. vehicle two-way RM ANOVA $n = 5$ mice per condition. **b** Two-way ANOVA $n = 6$ samples from six different mice per condition, obtained after one behavioral experiment. **d** Two-way ANOVA $n = 5$ samples from five different mice per condition, obtained after three independent experiments. **e** $***p < 0.001$ nitroglycerin vs. vehicle, three-way ANOVA $n = 6$ (Veh + Veh), $n = 5$ (NTG + Veh), $n = 6$ (Veh + WS12), $n = 7$ (NTG + Veh WS12) mice. **f** $*p < 0.05$ vs. vehicle. Multiple two-sided *t*-test $n = 4$ (WS12) or 7 (Vehicle) mice. **g** $+p < 0.05$ vs. vehicle. Two-sided Friedman test $n = 6$ mice. **h** $*p < 0.05$ vs. vehicle. Multiple two-sided *t*-test $n = 6$ mice per condition. ORX orchidectomy, NTG nitroglycerin, Veh vehicle. Source data are provided in Source Data file, statistical results in Supplementary Table 3.

antinociception in a sex-dependent fashion. Specifically, TRPM8 activity favors recovery in a mouse model of NTG-induced chronic migraine that produces similar acute mechanosensitivity in males and females but persistent chronic hypersensitivity exclusively in females. Our results suggest that testosterone by activating TRPM8 channels drives a sexual dimorphism characterized by recovery of normal sensitivity in males. We propose that the lack of this protective mechanism in females leads to a persistent mechanical hypersensitivity. Noteworthy, our model of chronic migraine mimics the sexual dimorphism observed in humans, characterized by stronger transitions to chronic sensitization in women³⁰ and possible faster recovery in men. Previous studies also described higher female sensitivity in models of formalin-inflammatory pain³⁷ and models of persistent pain such as stress-induced visceral hypersensitivity or muscle pain after repeated saline injections and forced activity^{29,37,38}. We considered the direct assessment of trigeminal sensitization in the head, however the repeated restraint stress required for this type of assessment could have been an additional factor in promoting sexual dimorphism³⁹. Overall, these findings suggest that the exposure to repeated noxious insults such as ongoing inflammation and stress-related stimuli favor the perpetuation of painful responses in females, whereas males show faster recovery and are able of reinstating their normal sensitivity.

In our model of chronic migraine, NTG provokes mechanical hypersensitivity by signaling through the TRPA1 channel, although this receptor is not involved in the sex dimorphism observed. Indeed, repeated NTG exposure induced similar TRPA1 mRNA overexpression in trigeminal ganglia of male and female mice. Increased expression translated into exacerbated TRPA1 activity and trigeminal cultures of males and females chronically exposed to NTG presented stronger TRPA1 activity in response to the specific agonist AITC. In line with our results, previous research described TRPA1-specific neuronal responses after acute NTG⁵, and male rodents exposed to NTG were sensitive to TRPA1 antagonism⁴⁰. Our findings reveal an essential participation of TRPA1 for the development of chronic NTG hypersensitivity in male and female mice, in agreement with studies showing TRPA1 involvement in persistent nociceptive sensitizations^{12,41,42}.

The NTG-TRPA1 mechanism involved in promoting the mechanical hypersensitivity relies on the release for α CGRP from trigeminal neurons^{11,12}, in agreement with the critical role of this neuropeptide in the aetiology of chronic migraine¹³. Our data further substantiate this tenet as sensitivity to the exocytosis inhibitor DDO4107 revealed a mechanism involving large dense core vesicles and vesicular fusion protein SNAP-25³². Notably, the data obtained with DDO4107 suggest a potential efficacy of this peptide for the treatment of chronic migraine through inhibition of α CGRP release, similar to botulinum neurotoxin¹⁴. Accordingly, we propose antagonistic roles of TRPA1 and TRPM8 activities determined by the continuous exposure to exogenous and endogenous agonists. Namely, nitric oxide derived from the

treatment with NTG elicits a hyperalgesic state via TRPA1 stimulation both in males and females, whereas testosterone exerts an antinociceptive role through interactions with TRPM8. Several mechanisms could underlie TRPM8-mediated antinociception. On the one hand, it has been proposed that TRPM8 activation produces silencing of C nociceptors expressing TRPA1⁴³ through interneuron recruitment in the spinal cord dorsal horn^{44,45} or via inhibitory metabotropic glutamatergic receptors expressed in the central terminal of nociceptors⁴⁶. Thus, in the studied pain models TRPM8 activity may occlude signaling of TRPA1-expressing nociceptors and subsequent CGRP release⁴³. In addition, a participation of central brain areas cannot be excluded from our data, given the recent description of TRPM8 also in supraspinal locations²⁷.

Notably, our results in TRPM8 knockout mice subjected to chronic NTG sensitization reveal a protective function of TRPM8. In line with our data, TRPM8 stimulation showed efficacy alleviating thermal hyperalgesia and nocifensive behaviors in models of headache-related pain^{44,45}. A protective function was similarly described in models of noxious heat or chemically-induced nociception such as the injection of capsaicin or the TRPA1 agonist acrolein^{24,43}. TRPM8 stimulation also provided alleviation of mechanical and cold sensitivity in models of chronic neuropathic pain^{47,48}. In accordance with these preclinical findings, TRPM8 agonists have been used medicinally for alleviating a variety of pain conditions including migraine^{19,20,49}, although using these compounds is not a first-line treatment for this clinical condition¹⁴. Our results may be in contrast with experiments recently published after the preprint of the present work in which TRPM8 is depicted as a trigger of nociceptive sensitization in the model of chronic migraine⁵⁰. While this work also stresses the relevance of TRPM8 for future investigations, we find experimental differences also involving NTG-induced sensitization that may explain the diverging results. Firstly, their exacerbated hypernociception may be associated with the combined use of NTG with propylene glycol as suggested by our data (Fig. 1 vs. Supplementary Fig. 1). Secondly, the NTG-induced hyperalgesia elicited in our model would have been overlooked in animals with a basal hypersensitive phenotype when compared to the mice used in our experimental conditions⁵⁰. Possible explanations to basal hyperreactivity include substrain differences or lack of habituation. Contradictory results were also published showing pro-algesic effects of TRPM8 agonists on migraine, although the use of TRPM8 agonists with partial effect on TRPA1 such as icilin could have yielded misleading results⁵¹. Similarly, we did not observe significant antinociception after administration of high WS12 doses in female mice treated with NTG. The absence of significant antinociception after WS12 could be associated to the potent and short-lasting effect of this compound, as suggested by the results obtained in the formalin test where significant effects lasted only 5 min in the acute phase. In agreement, calcium-dependent desensitization of TRPM8 is described

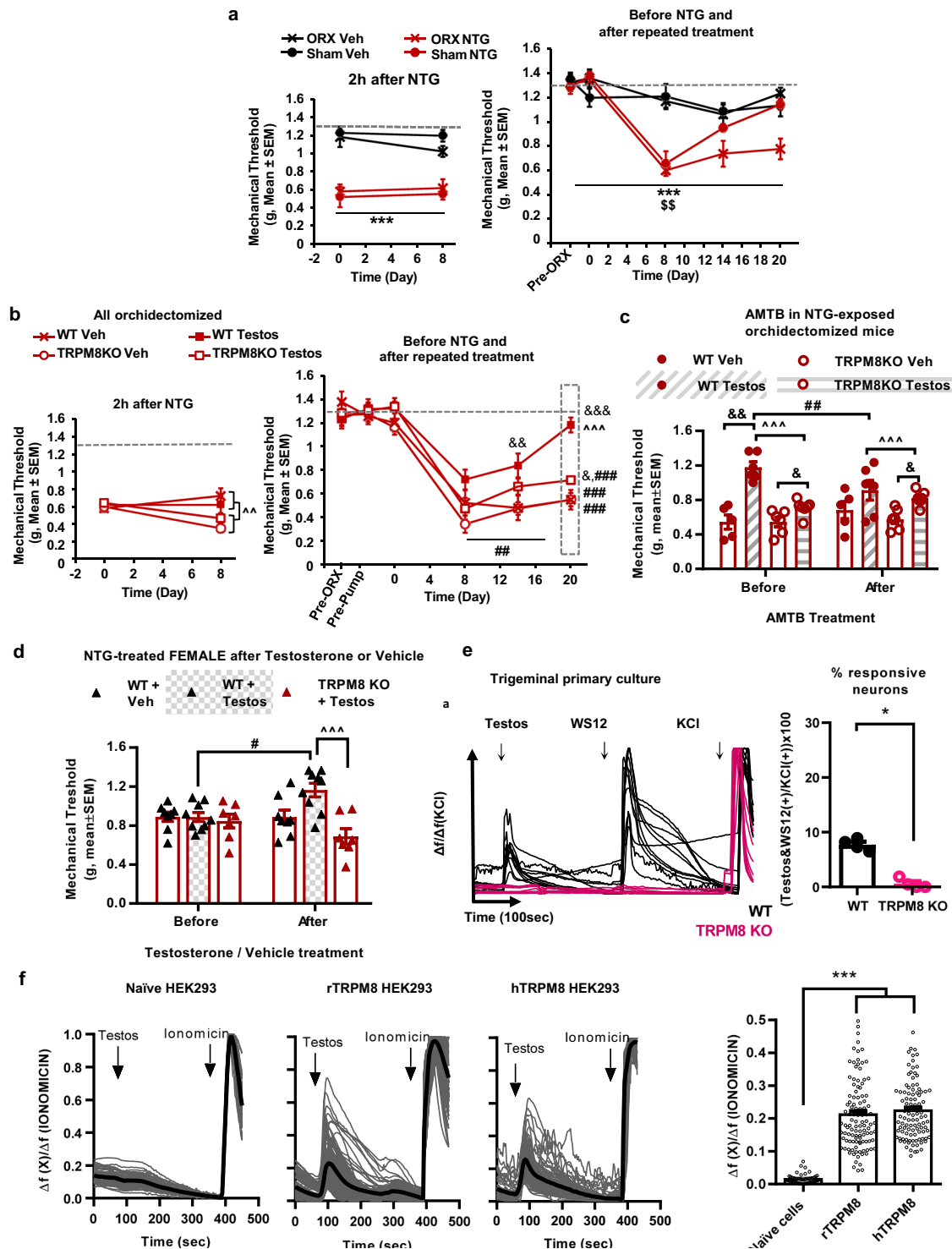

after application of the canonical TRPM8 agonists menthol, icilin or WS12⁵². In our von Frey experiments, reliable assessment of mechanosensitivity requires spaced and sequential application of von Frey filaments during periods of 15–30 min. Hence, mechanosensitivity could not be precisely assessed at that specific temporal resolution and a transient effect of WS12 could have been overlooked. In this line, short-lasting pain-relieving responses to menthol and its derivatives can be found clinically and were described elsewhere⁴⁹. On the other hand, the poor hydrosolubility of WS12 required its dissolution in corn oil for systemic administration and the lack of a significant effect could also be related to an erratic absorption and distribution of the compound.

The protective role of TRPM8 was ratified by the AMTB-induced resensitization of males already recovered from the chronic NTG treatment. This protective TRPM8 activity was corroborated in males previously subjected to the classical formalin test and is compatible with a latent nociceptive sensitization masked by tonic TRPM8 activity. The development of latent nociceptive sensitizations or hyperalgesic priming has been related to the establishment of chronic pain conditions^{53–55} and an endogenous opioid tone has been associated with this tonic inhibition of nociception⁵⁴. In this context, an interdependency between TRPM8 and the endogenous opioid system has been described, with TRPM8 knockout mice displaying reduced morphine analgesia and the antinociceptive effects of TRPM8 agonists

Fig. 4 | Testosterone stimulates neuronal TRPM8 to promote recovery of normal mechanosensitivity after chronic nitroglycerin treatment.

a Orchiectomized and sham mice display similar acute hypersensitivity after nitroglycerin (left panel), however only orchiectomized mice remain sensitized on day 21 (right). **b** Left, all orchidectomized mice show similar acute hypersensitivity after a first nitroglycerin dose, whereas after the last dose, orchidectomized TRPM8KO mice develop stronger sensitization. Right, mice receiving testosterone supplementation show inhibition of the long-lasting hypersensitivity induced after chronic nitroglycerin. This attenuation allows recovery of baseline sensitivity in wild-type mice, but not in TRPM8KO mice. **c** Testosterone-supplemented wild-type mice that recovered normosensitivity reinstate sensitization after AMTB on day 21. This response is absent in TRPM8 knockouts **d** Sensitized wild-type females recover basal sensitivity after acute testosterone treatment on day 21. **e** Cultured trigeminal neurons showing calcium transients after 10 pM testosterone also respond to 500 nM WS12 whereas TRPM8 knockouts are unresponsive. Right, 7% of neurons from wild-type trigeminal cultures show calcium transients after 10 pM testosterone and 500 nM WS12. This is abolished in TRPM8 knockouts. **f** 10 pM testosterone

elicits calcium transients in HEK293 cells when heterologously expressing rat or human TRPM8. Mean mechanical thresholds (**a–d**), response size (**e, f**) \pm S.E.M. Datapoints without error bars represent values of individual animals. **a** $^{***}p < 0.001$ vs. vehicle, $^{55}p < 0.01$ vs. sham, three-way RM ANOVA. $n = 6$ (Sham-Vehicle, Sham-NTG), $n = 5$ (ORX-Vehicle), $n = 7$ (ORX-NTG) mice. **b** $^{**}p < 0.01$, $^{***}p < 0.001$ vs. TRPM8KO; $^{56}p < 0.05$, $^{58}p < 0.01$ vs. testosterone vehicle; $^{##}p < 0.01$, $^{###}p < 0.001$ vs. baseline, three-way RM ANOVA. $n = 5$ (WT-Veh), $n = 6$ (WT-Testos and TRPM8KO-Veh), $n = 7$ (TRPM8KO-Testos) mice. **c** $^{***}p < 0.001$ vs. TRPM8KO; $^{56}p < 0.05$, vs. testosterone vehicle; $^{#}p < 0.01$ vs. basal, three-way RM ANOVA $n = 5$ (WT Veh), $n = 6$ (WT Testos and TRPM8KO Veh), $n = 7$ (TRPM8KO Testos) mice. **d** $^{***}p < 0.001$ vs. TRPM8KO, $^{#}p < 0.05$ vs. basal, two-way ANOVA $n = 7–9$ mice per condition. **e** $^{*}p < 0.05$ two-sided Mann–Whitney $U n = 4$ samples from four different mice per condition obtained in two independent experiments. **f** $^{***}p < 0.001$ vs. control, two-sided Mann–Whitney $U n = 64–100$ cells of two independent cultures per group. ORX orchidectomy, NTG nitroglycerin, Veh vehicle, Testos testosterone, TRPM8KO TRPM8 knockout. Source data are provided in Source Data file, statistical results in Supplementary Table 4.

being sensitive to the opioid antagonist naloxone^{33,56}. Our results suggest the interest of investigating opioid-TRPM8 interactions for the promotion of antinociception.

Noteworthy, testosterone application provided rapid TRPM8-mediated antinociception in females. In line with this finding, orchidectomized males showed persistent sensitization after chronic NTG similar to females. Previous studies also described decreased ability of orchidectomized males in restoring normal mechanosensitivity after inflammatory or stress-related insults^{29,37,38}. These studies elucidated testosterone antinociceptive mechanisms including transformation to di-hydrotestosterone and binding to androgen receptor³⁷, down-regulation of anti-opioid neurotransmitter Brain-derived Neurotrophic Factor (BDNF)³⁸ or modulation of serotonin transporters³⁹. In our study, orchidectomized wild-type males exposed to testosterone recovered their normal sensitivity after cessation of the NTG treatment, and this effect was largely dependent on TRPM8. These data reveal a function of TRPM8 providing endogenous antinociception in males though testosterone stimulation. Male-specific alterations have been previously observed in TRPM8 knockouts, including delayed cold acclimation and lower bone mineral density, similar to females of either genotype that showed this same phenotype⁵⁷. Interestingly, these features are also tightly linked to the activity of sexual steroids⁵⁸. We observed rapid antinociceptive effects of testosterone in NTG-exposed females in a time frame in which acute testosterone anxiolytic effects are also found⁵⁹. In agreement, preclinical studies show antinociceptive efficacy of testosterone in male and female rodent models of acute and chronic pain^{29,37,38}. Consistently, clinical treatments with testosterone may provide pain alleviation⁶⁰, and testosterone levels of men and women are inversely proportional to pain perception⁶¹ including migraine pain³¹. However, hormonal treatments are subjected to tight regulation and have transcriptional effects and deleterious consequences that limit their use.

Our trigeminal cultures revealed TRPM8 calcium transients in response to picomolar concentrations of testosterone⁶² that were absent in cultures of TRPM8 knockouts. Whole cell patch-clamp recordings in HEK cells heterologously expressing human TRPM8 also revealed ionic currents at low picomolar testosterone concentrations (EC₅₀ = 7 pM), in contrast to the lower potency of WS12 (EC₅₀ = 500 nM) obtained in the same experimental conditions. These testosterone-induced currents were independent of androgen receptor expression and sensitive to the TRPM8 antagonist AMTB, as revealed by the 5-fold decrease in testosterone potency (EC₅₀ increased from 7 to 34 pM) in the presence of 15 nM AMTB (IC₅₀ of AMTB against the less potent WS12). Note that the high potency of testosterone evoking TRPM8 ionic currents, requires higher AMTB concentrations to abolish testosterone-induced TRPM8 responses. Indeed, 10 μ M AMTB fully blocked testosterone-evoked ionic currents.

In agreement with our data, other groups have revealed TRPM8-mediated currents after application of picomolar concentrations of testosterone to cancer cells, somatosensory neurons²⁸ or planar lipid bilayers expressing TRPM8⁶³. Thus, testosterone induced rapid non-genomic effects on primary afferent neurons and other cell types through TRPM8. Similarly, other endogenous molecules such as oxytocin have shown agonistic effects over TRPV1 also at picomolar concentrations⁶⁴. While WS12 in the nanomolar range elicits stronger calcium transients than picomolar concentrations of testosterone, at the picomolar level TRPM8 agonists such as menthol, icilin or WS12 lack significant effects on intracellular calcium imaging²⁸. On the other hand, nanomolar concentrations of testosterone inhibited TRPM8⁶⁵ in HEK cells and neurons, suggesting possible inverted u-shaped dose-effect curves for this type of steroids. In agreement, picomolar concentrations of dihydrotestosterone induced pronounced over-expression of TRPM8 in cancer cells whereas higher concentrations had a reduced effect⁶⁶. Our calcium imaging, electrophysiological and behavioral results suggest an ionotropic effect of testosterone on TRPM8 channels and hint to the presence of a potential hormone binding site within the receptor structure. Docking simulations on a computational homology model of the human TRPM8 suggest the presence of a putative testosterone binding site in the receptor transmembrane domain with a theoretical binding energy and affinity consistent with the hormone potency (Supplementary Fig. 6a, b and Computational_files.zip). Furthermore, this putative ligand-receptor complex model suggests binding of testosterone to the active pocket described for WS12 and menthol^{52,67}. Interestingly, female hormones such as estradiol or progesterone were also able to be positioned in this binding pocket (Supplementary Fig. 6c, d and Computational_files.zip) although with lower binding energy estimates than testosterone. This agrees with the potency of estradiol and progesterone evoking TRPM8 ionic currents in planar lipid bilayers⁶³, as compared with testosterone. This computational docking model provides a testable hypothesis for future studies aimed to identify the molecular determinants of this putative binding site, either by structural and/or by structure-function studies. In this line TRPM3, another TRP channel of the melastatin family, has been established as a thermoreceptor⁶⁸ that also responds to sexual hormones such as pregnenolone and progesterone⁶⁹, suggesting a dual role of these protein types as detectors of both exogenous and endogenous stimuli. Our data indicate a testosterone-TRPM8 interaction that could be helpful for the design of novel compounds mimicking this channel agonist activity without the unwanted effects of hormonal treatments.

In conclusion, a high sensitization level of females has been found in a model that reproduces the sexual dimorphism and the enhanced cutaneous sensitivity associated with chronic migraine in humans⁷ and especially in women^{9,10}. This type of chronic sensitization could be

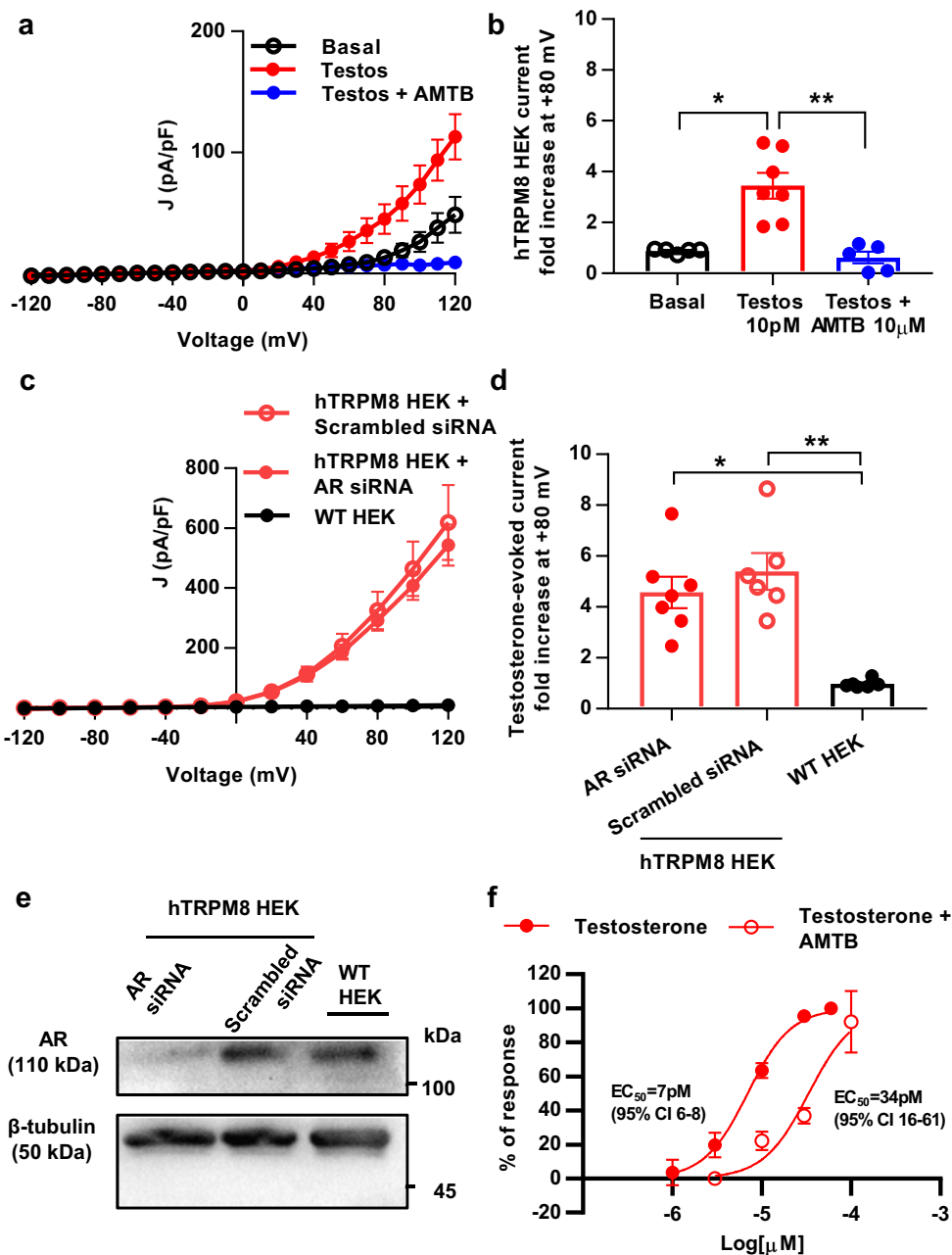

Fig. 5 | Testosterone increases outward current of heterologously expressed human TRPM8, independently of androgen receptor expression. **a** Current density (pA/pF) vs. voltage relationship evidences increase in outward rectifying current 10 pM testosterone in HEK293 cells expressing human TRPM8 (hTRPM8). 10 μ M AMTB inhibits testosterone effect ($n = 5$ cells from two independent cultures). Each cell received a testosterone pulse followed by a pulse of AMTB with testosterone. **b** 10 pM testosterone increases basal TRPM8 current at +80 mV ($n = 7$ cells from two independent cultures; $p < 0.017$ vs. Basal current) and 10 μ M AMTB reverses its effect ($n = 5$ cells from two cultures, $p < 0.009$ vs. 10 pM testosterone). **c** hTRPM8 HEK 293 cells (hTRPM8 HEK) transfected with small interfering RNA (siRNA) against androgen receptor (AR) ($n = 7$ from two cultures) and control hTRPM8 HEK transfected with scrambled siRNA ($n = 6$ from two cultures) show similar testosterone-induced outward rectifying current. This current is absent in wild-type HEK293 cells (WT HEK, $n = 6$ from 1 culture) lacking TRPM8. **d** At +80 mV, testosterone-evoked current is similar in anti-AR siRNA or scrambled siRNA-transfected hTRPM8 HEK cells, and this current is absent in wild-type HEK

($p < 0.046$ vs. anti-AR siRNA, $p < 0.005$ vs. scrambled siRNA). **e** Western blot of AR (110 kDa) and β -tubulin loading control (50 kDa) shows disrupted AR expression in anti-AR siRNA-transfected hTRPM8 HEK cells. WT HEK and scrambled siRNA-transfected hTRPM8 HEK cells display similar AR expression. **f** 15 nM AMTB (IC₅₀ for WS12 inhibition, Supplementary Fig. 5) shifts to the right the dose-response curve for testosterone-induced currents. EC₅₀ for testosterone (7 pM, 95% CI 6–8) increases in presence of AMTB (34 pM, 95% CI 16–61, $n = 9$ cells from three independent cultures for both dose-response curves). “ n ” indicates number of registered cells. **b**, **d** Data were subjected to Shapiro–Wilk normality tests, then Kruskal–Wallis followed by Mann–Whitney U tests were applied. ** $p < 0.01$, * $p < 0.05$. Data expressed as mean \pm SEM, dots on bar charts represent individual cells. EC₅₀s were estimated fitting data to a sigmoidal dose-response curve with constraints (Top = 100, Bottom = 0, GraphPad Prism Software). **e** is a representative western blot of two independent transfections. Source data are provided in Source Data file, statistical results in Supplementary Table 5.

aggravated after recurrent exposure to environmental factors involving TRPA1 stimulation such as pungent substances, oxidative stress or cyclic proinflammatory events⁷⁰. The present data reveals that the difference between males and females is mainly due to an increased antinociception of males. This effect relies partly on TRPM8 activity in response to endogenous testosterone, an androgenic hormone that is present at much higher levels in male individuals. Hence, novel molecules mimicking testosterone activity on TRPM8 could lack the unwanted effects of hormonal treatments and may provide effective pain relief for individuals with low testosterone levels of any gender. In addition, our data endorse the interest of analgesic drugs inhibiting TRPA1 activity for the treatment or prevention of migraine and pain syndromes characterized by enhanced mechanosensitivity in males and females^{2,43,71}, although careful modulation may be desirable since TRPA1 shows neuroprotective effects as a hypoxia sensor that drives vasodilation and reduces ischemic damage⁷².

Methods

Animals

Adult male and female mice with a C57BL/6J background (Envigo, Horst, The Netherlands), wild-type or defective in *Trpa1*⁷³ or *Trpm8*²³ were bred in the animal facility at Universidad Miguel Hernández (UMH, Elche, Alicante, Spain). Experiments involving solely wild-type C57BL/6J mice or TRPA1 knockout mice and their wild-type controls included 8–15-week-old age-matched mice, whereas experiments involving TRPM8 knockouts and their respective wild-type controls included age-matched groups of 8–20 week-old mice. TRPM8 knockout mice were a gift from Dr. F. Viana (Instituto de Neurociencias de Alicante, Alicante, Spain). Care was taken to minimize the number of animals used and the stress they experienced. All experimental procedures were approved by the Animal Care and Use Committees of Universidad Miguel Hernández and the regional government (code: 2018/VSC/PEA/0250-3) and were conducted according to the ethical principles of the International Association for the Study of Pain for the evaluation of pain in conscious animals⁷⁴, the European Parliament and the Council Directive (2010/63/EU) and the Spanish law (RD 53/2013). Housing conditions were maintained at $21 \pm 1^\circ\text{C}$ and $55 \pm 15\%$ relative humidity in a controlled light/dark cycle (light on between 8:00 a.m. and 8:00 p.m.). Animals had free access to food and water except during manipulations and behavioral assessment. Experiments were performed blinded for NTG, genotype or pharmacological treatment depending on the studied condition.

Model of chronic migraine

Animals were exposed to a schedule of repeated NTG injections previously used to precipitate long lasting mechanical hypersensitivity⁶. Briefly, mice were injected with 10 mg/kg NTG or its vehicle every other day for 8 days (5 i.p. injections total). Two different NTG formulations were tested: first, 5 mg/1.5 ml ampoules and second, 50 mg/50 ml vials (Bioindustria LIM, Novi Ligure, Italy). The 5 mg/1.5 ml ampoules contained NTG dissolved on a vehicle made of 1 ml propylene glycol and 0.5 ml ethanol (Bioindustria LIM). Such solution was further dissolved in saline to obtain 1 mg/ml NTG, reaching final concentrations of 10% ethanol and 20% propylene glycol. This preparation was no longer used after the first behavioral experiment because the treatment with vehicle induced mechanical nociceptive sensitization by itself as shown in Supplementary Fig. 1. The second NTG formulation consisted of 50 mg/50 ml NTG vials containing a vehicle made of 5% dextrose and 0.105% propylene glycol in pure water (Bioindustria LIM). This NTG formulation or its vehicle was administered without further dilution. Such preparation was chosen to complete all the remaining experiments because the vehicle did not modify nociceptive sensitivity. Both the first and the second preparations were administered at 10 ml/kg intraperitoneally (i.p.), obtaining the same NTG dose of 10 mg/kg as described⁶.

Experimental design

Detailed description of the rationale, timing and experimental design followed in each experiment can be found in Supplementary Methods within the Supplementary Information file.

Assessment of mechanical sensitivity

Mechanical thresholds were quantified by measuring the hind paw withdrawal response to von Frey filament stimulation. To decrease stress, prior to baseline measurements mice were habituated for 4 h to the testing environment during 2 days. On the evaluation days, animals were also allowed to habituate for 1–2 h before testing in order to obtain appropriate behavioral immobility. Briefly, animals were placed in Plexiglas® chambers (10 × 10 × 14 cm) with a wire grid bottom through which the von Frey filaments (bending force range from 0.008 to 2 g) (PanLab, Cornellá, Barcelona, Spain) were applied, by using the up-down paradigm as described⁷⁵. The filament of 0.4 g was first applied. Then, the strength of the next filament was decreased when the animal responded or increased when the animal did not respond. The upper limit value (2 g) was recorded as a positive response even if there was no withdrawal response, and the lower limit was recorded as negative even if there was withdrawal response (0.008). This up-down procedure was stopped 4 measures after the first change in animal responding (i.e., from response to no response or from no response to response). The sequence of the last 6 responses was used to calculate the mechanical threshold. Both ipsilateral and contralateral hind paws were alternatively tested whenever possible, and stimuli were applied at a minimum of 2 min intervals to avoid hypervigilance or sensitization between successive filament applications. Filaments were completely bent before considering responses and hold up to 4–5 s to consider a negative response. Clear paw withdrawal, shaking or licking were considered as nociceptive-like responses. The responses of both hind paws were averaged to obtain the mechanical threshold of each individual.

RNA extraction and RT-PCR

Trigeminal ganglia were isolated and frozen on dry ice until RNA extraction. Tissue was homogenized on ice using a polytron (Polytron PT 2000 Kinematica AG, Malters, Switzerland) and RNA was extracted with a TRIZOL (15596-026 Thermo Fisher Scientific) extraction method as described⁷⁶. Briefly, chloroform was added to yield 2 phases, including one hydrophilic phase at the top containing RNA. Then after centrifugation at $12,000 \times g$, 10 min at 4°C the aqueous phase was mixed with isopropanol to precipitate RNA. The resulting pellet was washed with ethanol and air-dried. RNA purity and quantity were assessed by spectrophotometry (NanoDrop 2000, Thermo Fisher Scientific). Retrotranscription to cDNA was conducted with First Strand Synthesis Kit (K1612, Thermo Fisher Scientific) using dT primers. Primers for cDNA amplification were: TRPA1 fw 5'-GCAGGTGG AACTTCATACCAA and rv 5'-CACTTTGCGTAAGTACCGACTGG, TRPM8 fw 5'-CTTTCTAAGCAATGGTATGGAG and rv 5'-GGTTTCTCC TAAATGATACGAG, GAPDH fw 5'-CCAATGTGTCCGTCGTGGATCT and rv 5'-GTTGAAGTCGAG GAGACAACC. Relative expression values were obtained by applying the equation $2^{-\Delta(\text{ACT gene of interest} - \Delta\text{CT GAPDH})}$.

Mouse trigeminal primary cultures

Adult mice (8–14 weeks) were sacrificed by cervical dislocation and trigeminal ganglia were extracted, micro-dissected from nerve projections and kept in ice-cold HBSS solution. Trigeminal ganglia were incubated in collagenase $48 \mu\text{g/ml}$, 3.5 U/mg (C7657, Merck) and dispase 3 mg/ml , 1.79 U/mg (17105-041, Thermo Fisher Scientific, Waltham, USA) for 45 min at 37°C in $5\% \text{ CO}_2$ ⁷⁷. Thereafter, samples were mechanically disaggregated by pipetting 15 times through a 1 ml blue plastic tip. Neurons were separated from other cell types and tissue debris by placing the tissue homogenate over a 15% BSA solution (073k7601, Merck) and centrifuged 7 min at $300 \times g$ ⁷⁸. Then, cells were

seeded in 5 μ l drops over crystals treated with 8.3 μ g/ml poly-L-Lysine (P9155, Merck) and 5 μ g/ml laminin (L2020, Merck). In total, 30 min after seeding cultures were supplemented with 500 μ l of culture medium and incubated for 12–16 h at 37 °C and 5% CO₂⁷⁷. Cells were kept in a hormone-free culture medium consisting of Dulbecco's Modified Eagle Medium/F12 (DMEM/F12) without Phenol Red (I1039021, Thermo Fisher Scientific), 1X Minimum Essential Medium (MEM) vitamin solution (I1120052, Thermo Fisher Scientific), 1% penicillin/streptomycin (15140-022, Thermo Fisher Scientific) and home-made μ g/ml N₂-containing insulin (I2643, Merck), 0.1 mM putrescine hydrochloride (P7505, Merck), 3 nM sodium selenite (S5261 Merck), 100 μ g/ml transferrin (T2872, Molecular Probes, Eugene, USA), 25 ng/ml NGF (G5141, Promega, Madison, USA) and 25 ng/ml hGDNF (450-10, Peprotech, London, UK).

Fluorescence Ca²⁺ imaging

Non-ratiometric calcium imaging experiments were conducted with the fluorescent indicator fluo4-AM (F14201, Thermo Fisher Scientific). Trigeminal neurons or Human Embryonic Kidney 293 (HEK293) cells (CRL-1573 ATCC) were incubated with 5 mM (6 mg/ml) fluo4-AM and 0.2% w/v pluronic acid (F-127, Thermo Fisher Scientific) for 60 min at 37 °C in standard extracellular solution (in mM: 140 NaCl, 3 KCl, 2.4 CaCl₂, 1.3 MgCl₂, 10 HEPES, and 5 glucose, adjusted to pH 7.4 with 1 M NaOH)⁷⁹. Afterwards, cells were washed with standard extracellular solution for at least 20 min. Fluorescence measurements were obtained on an inverted microscope (Axiovert 200/B, ZEISS) coupled to a Hamamatsu FLASH 4.0 LT camera (C11440-42U30, Hamamatsu, Sunayama-cho, Japan). Before starting the experiment, an image of the microscopic field was obtained with transmitted light to create the regions of interest around cells with neuronal morphology. Then, Fluo4 was excited at 480 nm (excitation time 200 ms) with a rapid gating shutter (lambda-shutter 10/2 Sutter instruments, Novato, USA). Mean fluorescence intensity was recorded for each cell with HCImage DIA software (Hamamatsu Photonics) every 3 s. Calcium imaging recordings were performed at 35 °C. Response sizes after agonists were calculated by measuring peak minus basal values and divided by the positive control of the experiment, i.e., 40 mM KCl in trigeminal primary cultures, and 10 μ M ionomycin in HEK293 and IMR90 human cell cultures. Responses were scored as positive if the increase in fluorescence was >0.2 arbitrary units⁷⁹. Substances dissolved in extracellular solution were delivered through a high-flow rate perfusion system controlled with an automatic system of valve clamps (PC-16 Bioscience Tools, S. Diego, USA). Cells were washed with extracellular solution between calcium responses for a period of at least 300 s to ensure recovery of basal fluorescence levels. Example dataset of calcium imaging (Fig. 2c, d) and the analysis instructions have been deposited in Github: https://github.com/greferball/Ca_Imaging_NatComm_2022.git

Drugs tested in behavioral studies

The TRPM8 selective blocker AMTB hydrochloride (AMTB, N-(3-aminopropyl)-2-[[3-methylphenyl] methyl] oxy}-N-(2-thienylmethyl) benzamide hydrochloride, Tocris, Bristol, UK) was dissolved in dimethyl sulfoxide (DMSO, Merck, Darmstadt, Germany) and was further diluted in saline to reach 2.5% DMSO. The range of AMTB doses (5–15 mg/kg i.p., 10 ml/kg) was chosen after dose conversion⁸⁰ from previous experiments demonstrating efficacy in attenuating hyperactive bladder activity in rats⁸¹. Mechanical sensitivity was measured 30 min after AMTB, based in previous behavioral results in mice⁸².

The potent and selective TRPM8 agonist WS12 ((1R,2S,5R)-2-Isopropyl-N-(4-methoxyphenyl)-5-methylcyclohexanecarboxamide, Tocris) was dissolved in DMSO and diluted in corn oil to reach 2.5% DMSO. The range of WS12 i.p. doses (5–15 mg/kg i.p., 10 ml/kg) was chosen based on previous data showing

antinociceptive effects of WS12 in mice³³. WS12 was administered 30 min prior assessment of mechanical sensitivity³³. In the formalin test, WS12 was dissolved in DMSO and diluted in saline up to 0.6% DMSO to achieve an amount of 6 nmol in 20 μ l as described³³. We used WS12 and not menthol or icilin as a TRPM8 agonist to avoid unspecific signaling over TRPA1⁸³.

Testosterone (T1500, Merck) was dissolved in 45% 2-Hydroxypropyl- β -cyclodextrin in water⁸⁴ to obtain a solution of 22 mg/ml for sustained delivery. This solution or its vehicle was introduced inside Alzet osmotic minipumps (Model 2004, Durect Corporation, Cupertino, CA, USA) to achieve a testosterone delivery of 6 μ g/h, based on previous studies obtaining significant effects in orchidectomized mice^{29,85}. In the experiments assessing the acute effect of testosterone in females, testosterone was dissolved in DMSO and diluted in corn oil to reach 2.5% DMSO as with WS12, and it was administered at 1 mg/kg, 1 h before the assessment of mechanosensitivity based on previous data assessing its effects on anxiety-like behavior⁸⁶.

Drugs for cellular studies

Fluo4-AM (F14201, Molecular Probes) was dissolved in DMSO at a concentration of 2 μ g/ μ l used on HBSS at a concentration of 6 μ g/ μ l to load the cells for calcium experiments. In calcium experiments, cells were under a constant flow of a standard extracellular solution (in mM: 140 NaCl, 3 KCl, 2.4 CaCl₂, 1.3 MgCl₂, 10 HEPES, and 5 glucose, adjusted to pH 7.4 with 1 M NaOH)⁷⁹, and stimuli were applied dissolved in this solution. Substances used in calcium imaging were 100 μ M AITC (W203408, Merck) dissolved in 0.001% DMSO, 500 nM WS12 (3040/50, Tocris) dissolved in 0.01% DMSO, 10 pM testosterone dissolved in 0.01% DMSO, 10 μ M ionomycin (I9657 Merck). NTG at 100 μ M (Bioindustry LIM) was used in calcium imaging and in the CGRP release assay in the formulation containing 5% dextrose and 0.105% propylene glycol as vehicle. In the CGRP release experiment, 10 μ M DD04107 (BCN Peptides SA, San Quintí de Mediona, Spain) dissolved in water was used⁷⁹.

CGRP release assay

Trigeminal cultures were incubated for 48 h, then cells were treated with the exocytosis inhibitor 10 μ M DD04107 (BCN Peptides SA, San Quintí de Mediona, Spain) or its vehicle (H₂O) for 1 h⁷⁷. Next, cells were treated with 100 μ M NTG or its vehicle (5% dextrose and 0.105% propylene glycol) for 30 additional min. Incubation solutions were made in culture medium and kept at 37 °C and 5% CO₂.

Immunocytochemistry

In total, 30 min after NTG exposure (vehicle 5% dextrose and 0.105% propylene glycol), the media was removed from the cells and the culture was washed with 1X PBS (D8662, Merck) 3 times⁷⁹. Afterwards, cells were fixed with 4% paraformaldehyde (158127, Merck) for 20 min at room temperature. Permeabilization was achieved with 0.1% v/v Triton 100X (P8787, Merck) for 5 min and blocking with 5% Normal Goat Serum (NGS, G9023, Merck) for 1 h, both in 1X PBS. Neurons were labeled with primary antibodies rabbit anti-MAP 1:250 (17490-I-AP, LabClinics, Barcelona, Spain) and mouse anti-CGRP 1:200 (AB81887, Abcam, Cambridge, UK) incubated overnight at 4 °C. Secondary antibodies goat anti-rabbit Alexa 488 1:1000 (A11034, Thermo Fisher Scientific) and goat anti-mouse Alexa 568 1:1000 (A11031, Thermo Fisher Scientific) were incubated for 1 h at room temperature and protected from light. Nuclei were stained with DAPI 1.5:10000 (D9564, Merck) for 5 min at room temperature. Slides were mounted with mowiol (475904, Merck) and images taken with a confocal microscope (LSM 900, ZEISS, Jena, Germany). Mean fluorescence intensity for each cell was obtained with ImageJ (Wayne Rasband, NIH), and the average value of positive cells was calculated for each picture.

Culture and transfection of human cell lines

Human embryonic kidney 293 cells (HEK293) were maintained in DMEM plus Glutamax, supplemented with 10% Fetal Bovine Serum (FBS, Thermo Fisher Scientific) and 1% penicillin/streptomycin, and incubated at 37 °C in 5% CO₂ atmosphere. For the study of TRPA1 function, HEK293 cells were plated in 24-well dishes at 2×10^5 cells/well and transiently transfected with human TRPA1 in a pCMV6-AC-GFP vector (Viktorie Vlachova, Czech Academy of Sciences) using Lipofectamine 3000 (Thermo Fisher Scientific)⁸⁷. For the transfection, 2 ml of Lipofectamine 3000 was mixed with the DNA in DMEM plus Glutamax with 1% FBS⁸⁷. IMR90 fibroblast-like cells (CCL-186 ATCC, Virginia, USA) were seeded in 12 mm coverslips at 50,000 cells/well and were maintained in MEM enriched with 10% FBS and 1% penicillin/streptomycin at 37 °C in 5% CO₂ atmosphere⁸⁸. For the initial experiments assessing TRPM8 function, HEK293 cells constitutively expressing human or rat TRPM8³⁵ were obtained from Prof. Belmonte Laboratory (Instituto de Neurociencias, San Juan, Alicante, Spain). All calcium imaging and electrophysiological recordings took place when cells reached 60% of confluence and 72 h after transfection when applicable.

Chemically-induced nocifensive behavior (formalin test)

Mice were individually placed into transparent chambers and were habituated for 1 h before testing. To evaluate the pain-relieving effect of WS12 against formalin-induced nocifensive behavior, 20 μ l of a 45% 2-Hydroxypropyl- β -cyclodextrin solution containing 5% formalin (F8775, Merck) and 0.6% DMSO with or without 6 nmol of WS12 were injected subcutaneously into the plantar aspect of the right hind paw (i.pl.) by using a Hamilton syringe (Hamilton Syringe Gastight™ serie 1700, TLL end, Merck) coupled to a 30-gauge needle. The time spent expressing nocifensive behavior (licking or biting of injected paw) was quantified in 5 min intervals during 60 min as described³⁴. To assess the influence of endogenous TRPM8 activity on the extinction of nocifensive behavior, mice received first 20 μ l of 5% formalin dissolved in saline in their right hind paw, and nocifensive behavior was quantified as above. After the initial 60 min when the nocifensive responses ceased, AMTB (10 mg/kg) or vehicle (2.5% DMSO in saline) were administered i.p. and behavioral quantification continued for 1 h.

Orchidectomy

Orchidectomy was adapted from a previous procedure⁸⁹ changing to a single midline scrotal incision to minimize tissue injury. Briefly, mice were anesthetized with a mixture of i.p. ketamine (75 mg/kg; Imalgene, 100 mg/ml, Boehringer Ingelheim, Ingelheim/Rhein, Germany) and xylazine (15 mg/kg, Merck) and a single midline scrotal incision was made. The testes were exposed, and the vas deferens and testicular blood vessels were ligated with 2 tight knots of 6-0 black silk (8065195601, Alcon Cusi S.A., Barcelona, Spain). An incision was made between the 2 knots to remove testes and epididymis and the incision was closed with three additional square knots after ensuring hemostasis. Sham surgeries were performed similarly but the testicles were exposed and not ligated or removed. Subsequent nociceptive evaluations were conducted 3 weeks after surgeries.

Testosterone replacement treatment

Testosterone or its vehicle (45% 2-Hydroxypropyl)- β -cyclodextrin (in water) were placed into Alzet osmotic minipumps (Model 2004, 0.23 μ l/h for 28 days) following manufacturer instructions. Minipumps were implanted subcutaneously between the scapulae under ketamine (75 mg/kg)-xylazine (15 mg/kg) anaesthesia. The pump was set to deliver vehicle or testosterone at an estimated dose of 6 μ g/h, based on previous studies obtaining significant effects in orchidectomized mice^{29,85}. Testing and NTG injections began after 3 days of minipump implantation.

Patch-clamp whole-cell recordings

Whole-cell recordings were conducted using an EPC-10 amplifier with Patchmaster software (both from HEKA Elektronik, Dr. Schulze GmbH, Germany). Patch pipettes, prepared from thin-wall borosilicate capillary glass tubing (Warner Instruments, Hamden CT, USA) were pulled with a horizontal flaming/brown Micropipette puller Model P-97 from Sutter Instruments to a final resistance of 2–4 M Ω when filled with internal solution. Recordings were acquired at 10 kHz and low-pass filtered at 3 kHz. Recordings with leak currents >200 pA or series resistance >15 M Ω were discarded. Cells were seeded on 12 mm diameter glass coverslips treated with poly-L-lysine solution. Intracellular pipette solution contained in mM: 150 NaCl, 3 MgCl₂, 5 EGTA and 10 HEPES, pH 7.2 with CsOH. Extracellular physiological solution contained (in mM): 150 NaCl, 6 CsCl, 1 MgCl₂, 1.5 CaCl₂, 10 glucose and 10 HEPES, pH 7.4 with NaOH. All measurements were performed at room temperature. After seal opening, cells were maintained at a holding potential of –60 mV for few minutes and then a voltage ramp from –120 to +120 mV of 300 ms duration was applied.

Knockdown of androgen receptor in HEK 293 cells expressing human TRPM8

HEK293 cells expressing human TRPM8³⁵ (Prof. Belmonte Laboratory, Instituto de Neurociencias, San Juan, Alicante, Spain) were cultured in EMEM (ATCC, 30-2003), 1% penicillin/streptomycin (Gibco, 15140-122), 1% geneticin (Gibco, 10131-019), 10% FBS (Gibco, 16000-044), 2 mM L-glutamine (Gibco, A2916801) and 2.5 mg/ml glucose (Sigma, G8270). T25 flasks at 80% confluency were transfected with DMEM plus Glutamax (Gibco, 61965-026), 1% Penicillin/Streptomycin (Gibco, 15140-122), 19.6 μ l of Lipofectamine 3000 (Invitrogen, L3000-015), 1 μ g of androgen receptor siRNA (Thermo Fisher, Ambion, s1538; sense GCCCAUUGACUUAUUACUUUtt; antisense AAAGUAAUAGUCAUUGG Cca) or negative control scramble siRNA (Thermo Fisher, Ambion, 4390843) and 6.5 μ g of pcDNA3eGFP plasmid DNA (Addgene plasmid #13031). After 72 h, GFP expression was assessed to ensure that the transfection had been successful and western blot or patch clamp were performed. GFP was excited at 500 nm with an exposure time of 500 ms and emitted fluorescence was filtered at 535 nm (Lambda-10-2-filter wheel, Sutter Instruments). The cells were imaged under a \times 10 air objective (Axiovert 200 inverted microscope, Carl Zeiss) with an ORCA Flash LT camera (Hamamatsu Photonics) and visually compared to non-transfected hTRPM8 HEK cells to estimate the efficiency of transfection. For patch clamp experiments, cells were seeded in 12 mm poly-L-lysine (Sigma-Aldrich, P4707) treated coverslips at 20,000 cells/well.

Protein extraction and western blotting

Total protein from HEK 293 cells was extracted using lysis buffer (150 mM NaCl, 50 mM Tris-Base, 1 mM EDTA, 1% Triton X-100, 0.5% sodium deoxycholate, 0.1% SDS, pH 8) containing 1:100 Halt Protease Inhibitor Cocktail EDTA-free (87785, Thermo Scientific). After 40 min incubation with lysis buffer, solubilized proteins were collected by centrifugation at 9400 \times g for 15 min. Protein concentration was determined with Pierce BCA Protein Assay Kit (23225, Thermo Scientific). In total, 20 μ g of total protein were prepared in loading buffer (10X: 600 mM Tris-HCl, 400 mM DTT, 1% bromophenol blue, 20% SDS, 50% glycerol, pH 6.8) and heated up to 95 °C for 5 min before loading the gel. Proteins were separated by SDS-PAGE in 7.5% gels. Electrophoresis ran in running buffer (0.3% Tris-Base, 1.44% glycine, 0.1% SDS, pH 8.4) at 100 V during the first 10 min, and then at 150 V until the end. Separated proteins were transferred onto a 0.45 μ m nitrocellulose membrane (Bio-Rad) using a wet blotting system for 2 h at 100 V and 4 °C in transfer buffer (25 mM Tris-Base, 190 mM glycine, 0.1% SDS, 20% methanol, pH 8.4). Afterwards, the membrane was blocked with 5% BSA for 1 h. Androgen receptor (AR) and β -tubulin were probed with

specific primary antibodies anti-AR (1:100 in 1% BSA/TBST; sc-7305, Santa Cruz Biotechnology) and anti- β -tubulin (1:1000 in 2.5% BSA/TBST; 10094-1-AP, Proteintech) and were incubated overnight (16 h) at 4 °C. After six 5-min washes with TBST (20 mM Tris-Base, 150 mM NaCl, 0.1% Tween-20, pH 7.5) the membrane was incubated with secondary antibodies anti-mouse IgG-HRP (1:10,000 in 1% BSA/TBST; A4416, Sigma) or anti-rabbit IgG-HRP (1:25,000 in 2.5% BSA-TBST; A0545, Sigma) for 1 h at room temperature. After six 5-min washes with TBST, proteins were detected with substrate SuperSignal West Pico Plus (34577, Thermo Scientific). Chemiluminescence was visualized with ChemiDoc imaging system (Bio-Rad).

Statistical analyses

Time courses of nociceptive behavioral data conducted in male and female mice were analyzed using two-way repeated measures ANOVA with time as within-subjects factor and NTG treatment or genotype as between-subject factors. The time courses involving orchidectomized animals were analyzed with three-way repeated measures ANOVA, with time as within-subjects factor and either NTG and orchidectomy or genotype and testosterone as between-subject factors. Levene's test of equality of error variances and Mauchly's sphericity tests were used to assess normality of the data and Bonferroni post hoc pairwise comparisons were subsequently conducted when appropriate. Three-way ANOVA was also used to analyze the data of WS12 experiments (time point, WS12, NTG) whereas a within-design was chosen to analyze the effects of the AMTB doses in wild-type males recovered from sensitization (Friedman's test followed by Benjamini adjustment). A three-way ANOVA was also used to analyze AMTB effects on NTG-exposed orchidectomized animals (Time point, Testosterone, Genotype). The time-course data of the chemically-induced nocifensive behavior was analyzed with repeated unadjusted *t*-tests to avoid assumptions of similar variances for the first and the second phases of the formalin test and posterior measurements. For the cellular studies, data normality was first assessed with D'Agostino–Pearson or Shapiro–Wilk test for the patch recordings. Then, comparisons of two groups were analyzed accordingly with *t*-tests or Mann–Whitney *U* tests, whereas comparisons of more than two groups were analyzed with either one-way ANOVA followed by Bonferroni or Kruskal–Wallis followed by Mann–Whitney *U* tests. RT-PCR and cellular data containing two factors were analyzed with two-way ANOVA followed by Bonferroni. Sample size for animal and cellular studies was estimated based on previous experience in our laboratories using similar behavioral and cellular approaches^{79,87,90}. Raw data can be found in the Source Data File and results of the statistical tests are included in the Supplementary Information file. Throughout the manuscript, data are expressed as mean \pm SEM values and individual datapoints are shown whenever possible. Differences were considered statistically significant when *p* values were <0.05. Statistical analyses were performed using IBM SPSS 25 Software (IBM, Chicago, IL, USA), Microsoft Excel 2019 MSO (Redmond, WA, USA) and GraphPad Prism 7.04 (GraphPad Software Inc., San Diego, CA, USA). Additional distribution data can be found in the Supplementary Statistical Results subsection of the Supplementary Information file.

Reporting summary

Further information on research design is available in the Nature Research Reporting Summary linked to this article.

Data availability

All source data from the figures are available within the manuscript as a Source data file and results of statistical analyses are provided within the Supplementary Information file. Example dataset of calcium imaging (Fig. 2c, d) and analysis instructions have been deposited in Github: https://github.com/grefferball/Ca_Imaging_NatComm_2022.git. All the calcium imaging datasets generated and analyzed during

the study are available from the corresponding authors on request. Data used for computational analyses are available as Supplementary Information in the zip folder Computational_files.zip which contains instructions in a readme.txt and scripts. Source data are provided with this paper.

References

- Safiri, S. et al. Global, regional, and national burden of migraine in 204 countries and territories, 1990 to 2019. *Pain* **163**, E293–E309 (2022).
- Iannone, L. F., De Logu, F., Geppetti, P. & De Cesaris, F. The role of TRP ion channels in migraine and headache. *Neurosci. Lett.* **768**, 136380 (2022).
- Ferrari, M. D. et al. Migraine. *Nat. Rev. Dis. Prim.* **8**, 2 (2022).
- Demartini, C. et al. Nitroglycerin as a comparative experimental model of migraine pain: from animal to human and back. *Prog. Neurobiol.* **177**, 15–32 (2019).
- Marone, I. M. et al. TRPA1/NOX in the soma of trigeminal ganglion neurons mediates migraine-related pain of glyceryl trinitrate in mice. *Brain* **141**, 2312–2328 (2018).
- Pradhan, A. et al. Characterization of a novel model of chronic migraine. *Pain* **155**, 269–274 (2014).
- Louter, M. A. et al. Cutaneous allodynia as a predictor of migraine chronification. *Brain* **136**, 3489–3496 (2013).
- Han, S. M. et al. Prevalence and characteristics of cutaneous allodynia in probable migraine. *Sci. Rep.* **11**, 2467 (2021).
- Bigal, M. E. et al. Prevalence and characteristics of allodynia in headache sufferers: a population study. *Neurology* **70**, 1525–1533 (2008).
- Scher, A. I. et al. Epidemiology of migraine in men: results from the Chronic Migraine Epidemiology and Outcomes (CaMEO) Study. *Cephalalgia* **39**, 296–305 (2019).
- Nassini, R. et al. The 'headache tree' via umbellulone and TRPA1 activates the trigeminovascular system. *Brain* **135**, 376–390 (2012).
- De Logu, F. et al. Schwann cells expressing nociceptive channel TRPA1 orchestrate ethanol-evoked neuropathic pain in mice. *J. Clin. Invest.* **129**, 5424–5441 (2019).
- Charles, A. & Pozo-Rosich, P. Targeting calcitonin gene-related peptide: a new era in migraine therapy. *Lancet* **394**, 1765–1774 (2019).
- Ashina, M. et al. Migraine: integrated approaches to clinical management and emerging treatments. *Lancet* **397**, 1505–1518 (2021).
- Denner, A. C., Vogler, B., Messlinger, K. & De Col, R. Role of transient receptor potential ankyrin 1 receptors in rodent models of meningeal nociception—experiments in vitro. *Eur. J. Pain.* **21**, 843–854 (2017).
- Paige, C. et al. A female-specific role for calcitonin gene-related peptide (CGRP) in rodent pain models. *J. Neurosci.* **42**, 1930–1944 (2022).
- Chasman, D. I. et al. Genome-wide association study reveals three susceptibility loci for common migraine in the general population. *Nat. Genet.* **43**, 695–698 (2011).
- Ling, Y. H., Chen, S. P., Fann, C. S. J., Wang, S. J. & Wang, Y. F. TRPM8 genetic variant is associated with chronic migraine and allodynia. *J. Headache Pain* **20**, 115 (2019).
- Borhani-Haghighi, A. et al. Cutaneous application of menthol 10% solution as an abortive treatment of migraine without aura: a randomised, double-blind, placebo-controlled, crossed-over study. *Int J. Clin. Pr.* **64**, 451–456 (2010).
- St. Cyr, A. et al. Efficacy and tolerability of STOPAIN for a migraine attack. *Front. Neurol.* **6**, 11 (2015).
- Andersen, H. H., Gazerani, P. & Arendt-Nielsen, L. High-concentration L-menthol exhibits counter-irritancy to neurogenic inflammation, thermal and mechanical hyperalgesia caused by trans-cinnamaldehyde. *J. Pain.* **17**, 919–929 (2016).

22. Peier, A. M. et al. A TRP channel that senses cold stimuli and menthol. *Cell* **108**, 705–715 (2002).
23. Bautista, D. M. et al. The menthol receptor TRPM8 is the principal detector of environmental cold. *Nature* **448**, 4–9 (2007).
24. Dhaka, A. et al. TRPM8 is required for cold sensation in mice. *Neuron* **54**, 371–378 (2007).
25. Pérez De Vega, M. J., Gómez-Monterrey, I., Ferrer-Montiel, A. & González-Muñiz, R. Transient receptor potential melastatin 8 channel (TRPM8) modulation: cool entryway for treating pain and cancer. *J. Med. Chem.* **59**, 10006–10029 (2016).
26. Liu, Y. et al. TRPM8 channels: a review of distribution and clinical role. *Eur. J. Pharmacol.* **882**, 173312 (2020).
27. Ordás, P. et al. Expression of the cold thermoreceptor TRPM8 in rodent brain thermoregulatory circuits. *J. Comp. Neurol.* **529**, 234–256 (2021).
28. Asuthkar, S. et al. The TRPM8 protein is a testosterone receptor: II. Functional evidence for an ionotropic effect of testosterone on TRPM8. *J. Biol. Chem.* **290**, 2670–2688 (2015).
29. Lesnak, J. B., Inoue, S., Lima, L., Rasmussen, L. & Sluka, K. A. Testosterone protects against the development of widespread muscle pain in mice. *Pain* **161**, 2898–2908 (2020).
30. Rosen, S., Ham, B. & Mogil, J. Sex differences in neuroimmunity and pain. *J. Neurosci. Res.* **95**, 500–508 (2017).
31. Shields, L. B. E., Seifert, T., Shelton, B. J. & Plato, B. M. Testosterone levels in men with chronic migraine. *Neurol. Int* **11**, 8079 (2019).
32. Camprubí-Robles, M., Planells-Cases, R., Ferrer-Montiel, A. & Robles, C. Differential contribution of SNARE-dependent exocytosis to inflammatory potentiation of TRPV1 in nociceptors. *FASEB J.* **23**, 3722–3733 (2009).
33. Liu, B. et al. TRPM8 is the principal mediator of menthol-induced analgesia of acute and inflammatory pain. *Pain* **154**, 2169–2177 (2013).
34. McNamara, C. R. et al. TRPA1 mediates formalin-induced pain. *Proc. Natl Acad. Sci. USA* **104**, 13525–13530 (2007).
35. Journigan, V. B. et al. Structural and in vitro functional characterization of a menthyl TRPM8 antagonist indicates species-dependent regulation. *ACS Med. Chem. Lett.* **12**, 758–767 (2021).
36. Diver, M. M., Cheng, Y. & Julius, D. Structural insights into TRPM8 inhibition and desensitization. *Science* **365**, 1434–1440 (2019).
37. Fanton, L. E., Macedo, C. G., Torres-Chávez, K. E., Fischer, L. & Tambeli, C. H. Activational action of testosterone on androgen receptors protects males preventing temporomandibular joint pain. *Pharm. Biochem. Behav.* **152**, 30–35 (2017).
38. Ji, Y., Hu, B., Li, J. & Traub, R. J. Opposing roles of estradiol and testosterone on stress-induced visceral hypersensitivity in rats. *J. Pain* **19**, 764–776 (2018).
39. Watanabe, M. et al. Dysregulation of serum prolactin links the hypothalamus with female nociceptors to promote migraine. *Brain* <https://doi.org/10.1093/brain/awac104> (2022).
40. Demartini, C. et al. The role of the transient receptor potential ankyrin type-1 (TRPA1) channel in migraine pain: evaluation in an animal model. *J. Headache Pain.* **18**, 94 (2017).
41. Liu, C. et al. A non-covalent ligand reveals biased agonism of the TRPA1 ion channel. *Neuron* **109**, 273–284 (2021).
42. Martínez-Rojas, V. A. et al. Peripheral and spinal TRPA1 channels contribute to formalin-induced long-lasting mechanical hypersensitivity. *J. Pain. Res.* **11**, 51–60 (2018).
43. Liu, B. Y. et al. Menthol suppresses laryngeal C-fiber hypersensitivity to cigarette smoke in a rat model of gastroesophageal reflux disease: the role of TRPM8. *J. Appl. Physiol.* **118**, 635–645 (2015).
44. Kayama, Y. et al. Functional interactions between transient receptor potential M8 and transient receptor potential V1 in the trigeminal system: relevance to migraine pathophysiology. *Cephalalgia* **38**, 833–845 (2018).
45. Ren, L., Dhaka, A. & Cao, Y. Q. Function and postnatal changes of dural afferent fibers expressing TRPM8 channels. *Mol. Pain.* **11**, 37 (2015).
46. Proudfoot, C. J. et al. Analgesia mediated by the TRPM8 cold receptor in chronic neuropathic pain. *Curr. Biol.* **16**, 1591–1605 (2006).
47. Knowlton, W. et al. A sensory-labeled line for cold: TRPM8-expressing sensory neurons define the cellular basis for cold, cold pain, and cooling-mediated analgesia. *J. Neurosci.* **33**, 2837–2848 (2013).
48. Patel, R. et al. Anti-hyperalgesic effects of a novel TRPM8 agonist in neuropathic rats: a comparison with topical menthol. *Pain* **155**, 2097–2107 (2014).
49. Eccles, R. Menthol and related cooling compounds. *J. Pharm. Pharmacol.* **46**, 618–630 (1994).
50. Wei, C., Kim, B. & McKemy, D. D. Transient receptor potential melastatin 8 (TRPM8) is required for nitroglycerin and calcitonin gene-related peptide induced migraine-like pain behaviors in mice. *Pain* <https://doi.org/10.1097/j.pain.0000000000002635> (2022).
51. Burgos-Vega, C. et al. Meningeal transient receptor potential channel M8 activation causes cutaneous facial and hindpaw allodynia in a preclinical rodent model of headache. *Cephalalgia* **36**, 185–193 (2016).
52. Yin, Y. et al. Structural basis of cooling agent and lipid sensing by the cold-activated TRPM8 channel. *Science* **363**, 9334 (2019).
53. Reichling, D. B. & Levine, J. D. Critical role of nociceptor plasticity in chronic pain. *Trends Neurosci.* **32**, 611–618 (2009).
54. Corder, G. et al. Constitutive μ -opioid receptor activity leads to long-term endogenous analgesia and dependence. *Science* **341**, 1394–1399 (2013).
55. Cabañero, D., Campillo, A., Célérier, E., Romero, A. & Puig, M. M. Pronociceptive effects of remifentanyl in a mouse model of post-surgical pain: effect of a second surgery. *Control* **111**, 1334–1345 (2009).
56. Shapovalov, G. et al. Opiates modulate thermosensation by internalizing cold receptor TRPM8. *Cell Rep.* **4**, 504–515 (2013).
57. Carvalho, A. L. et al. TRPM8 modulates temperature regulation in a sex-dependent manner without affecting cold-induced bone loss. *PLoS ONE* **16**, e0231060 (2021).
58. Khosla, S. & Monroe, D. G. Regulation of bone metabolism by sex steroids. *Cold Spring Harb. Perspect. Med.* **8**, a031211 (2018).
59. Frye, C. A., Koonce, C. J., Edinger, K. L., Osborne, D. M. & Walf, A. A. Androgens with activity at estrogen receptor beta have anxiolytic and cognitive-enhancing effects in male rats and mice. *Horm. Behav.* **54**, 726–734 (2008).
60. White, H. D. & Robinson, T. D. A novel use for testosterone to treat central sensitization of chronic pain in fibromyalgia patients. *Int. Immunopharmacol.* **27**, 244–248 (2015).
61. Bartley, E. J. et al. Natural variation in testosterone is associated with hypoalgesia in healthy women. *Clin. J. Pain.* **31**, 730–739 (2015).
62. Yoo, H. S. & Napoli, J. L. Quantification of dehydroepiandrosterone, 17 β -estradiol, testosterone, and their sulfates in mouse tissues by LC-MS/MS. *Anal. Chem.* **91**, 14624–14630 (2019).
63. Mohandass, A. et al. TRPM8 as the rapid testosterone signaling receptor: implications in the regulation of dimorphic sexual and social behaviors. *FASEB J.* **34**, 10887–10906 (2020).
64. Nersesyan, Y. et al. Oxytocin modulates nociception as an agonist of pain-sensing TRPV1. *Cell Rep.* **21**, 1681–1691 (2017).
65. Gkika, D. et al. Testosterone-androgen receptor: the steroid link inhibiting TRPM8-mediated cold sensitivity. *FASEB J.* **34**, 7483–7499 (2020).

66. Bidaux, G. Evidence for specific TRPM8 expression in human prostate secretory epithelial cells: functional androgen receptor requirement. *Endocr. Relat. Cancer* **12**, 367–382 (2005).
67. Yin, Y. et al. Structure of the cold- and menthol-sensing ion channel TRPM8. *Science* **359**, 237–241 (2018).
68. Paricio-Montesinos, R. et al. The sensory coding of warm perception. *Neuron* **106**, 830–841.e3 (2020).
69. Majeed, Y. et al. Pregnenolone sulphate-independent inhibition of TRPM3 channels by progesterone. *Cell Calcium* **51**, 1–11 (2012).
70. Giorgi, S., Nikolaeva-Koleva, M., Alarcón-Alarcón, D., Butrón, L. & González-Rodríguez, S. Is TRPA1 burning down TRPV1 as druggable target for the treatment of chronic pain. *Int. J. Mol. Sci.* **20**, 2906 (2019).
71. Ferrer-Montiel, A. et al. Advances in modulating thermosensory TRP channels. *Expert Opin. Ther. Pat.* **22**, 999–1017 (2012).
72. Pires, P. W. & Earley, S. Neuroprotective effects of trpa1 channels in the cerebral endothelium following ischemic stroke. *Elife* **7**, e35316 (2018).
73. Kwan, K. Y. et al. TRPA1 contributes to cold, mechanical, and chemical nociception but is not essential for hair-cell transduction. *Neuron* **50**, 277–289 (2006).
74. Zimmermann, M. Ethical considerations in relation to pain in animal experimentation. *Acta Physiol. Scand. Suppl.* **554**, 221–233 (1986).
75. Chaplan, S. R. et al. Quantitative assessment of tactile allodynia in the rat paw. *J. Neurosci. Methods* **53**, 55–63 (1994).
76. Chomzynski, P. Single-step method of RNA isolation by acid guanidinium thiocyanate–phenol–chloroform extraction. *Anal. Biochem.* **162**, 156–159 (1987).
77. Ponsati, B. et al. An inhibitor of neuronal exocytosis (DDO4107) displays long-lasting in vivo activity against chronic inflammatory and neuropathic pain. *J. Pharmacol. Exp. Ther.* **341**, 634–645 (2012).
78. Jocher, G., Mannschatz, S. H., Offterdinger, M. & Schweigreiter, R. Microfluidics of small-population neurons allows for a precise quantification of the peripheral axonal growth state. *Front. Cell Neurosci.* **12**, 166 (2018).
79. Devesa, I. et al. α CGRP is essential for algescic exocytotic mobilization of TRPV1 channels in peptidergic nociceptors. *Proc. Natl Acad. Sci. USA* **111**, 18345–18350 (2014).
80. Nair, A. & Jacob, S. A simple practice guide for dose conversion between animals and human. *J. Basic Clin. Pharm.* **7**, 27–31 (2016).
81. Lashinger, E. S. R. et al. AMTB, a TRPM8 channel blocker: evidence in rats for activity in overactive bladder and painful bladder syndrome. *Am. J. Physiol. Renal Physiol.* **295**, F803–10 (2008).
82. Willis, D. N., Liu, B., Ha, M. A., Jordt, S. & Morris, J. B. Menthol attenuates respiratory irritation responses to multiple cigarette smoke irritants. *FASEB J.* **25**, 4434–4444 (2011).
83. Karashima, Y. et al. Bimodal action of menthol on the transient receptor potential channel TRPA1. *J. Neurosci.* **27**, 9874–9884 (2007).
84. Donner, D. G. et al. Trenbolone improves cardiometabolic risk factors and myocardial tolerance to ischemia-reperfusion in male rats with testosterone-deficient metabolic syndrome. *Endocrinology* **157**, 368–381 (2016).
85. Zhao, R. et al. A GPR174–CCL21 module imparts sexual dimorphism to humoral immunity. *Nature* **577**, 416–420 (2020).
86. Frye, C. A., Edinger, K. & Sumida, K. Androgen administration to aged male mice increases anti-anxiety behavior and enhances cognitive performance. *Neuropsychopharmacology* **33**, 1049–1061 (2008).
87. Nikolaeva-Koleva, M. et al. A capsaicinoid-based soft drug, AG1529, for attenuating TRPV1-mediated histaminergic and inflammatory sensory neuron excitability. *Sci. Rep.* **11**, 246 (2021).
88. Tonello, R. et al. The peptide Phc1 β , from spider venom, acts as a TRPA1 channel antagonist with antinociceptive effects in mice. *Br. J. Pharm.* **174**, 57–69 (2017).
89. Sophocleous, A. & Idris, A. I. Ovariectomy/orchiectomy in rodents. *Methods Mol. Biol.* **1914**, 261–267 (2019).
90. Cabañero, D. et al. Protective role of neuronal and lymphoid cannabinoid CB2 receptors in neuropathic pain. *Elife* **9**, 1–24 (2020).

Acknowledgements

We are thankful to the following funding bodies: grants from MICIN/AEI No. SAF2015-66275-C2-1-R and RTI2018-097189-B-C21 (DOI /10.13039/501100011033, ERDF A way of making Europe, by the “European Union”) to A.F.M. and A.F.C., and fellowship grants BES-2016-077985 to D.A.A. and PRE2019-091317 to J.d.A.L.; grants from GVA, PROMETEO/2021/031 to A.F.M. and A.F.C.; UMH-PAR2019 to A.F.C. and A.F.M.; GVA fellowship grant GRISOLIAP/2019/09444/19 to S.G. Authors thank Gema Osuna Tenorio, Laura Butrón and José Manuel Serrano Garcia for their help and technical expertise. We thank Dr. F. Viana for providing the TRPM8 knockout mice.

Author contributions

D.A.A. conducted calcium imaging, cell culture, immunofluorescence, RT-PCR experiments, performed formalin behavioral assays, designed experiments, analyzed the data, wrote and edited the first and subsequent drafts of the manuscript. D.C. conducted all behavioral assays, performed surgeries, analyzed the data, conceptualized and designed experiments, coordinated in vivo, in vitro and computerized experiments and wrote and edited the first and subsequent drafts of the manuscript. J.d.A.L. executed and analyzed docking experiments, conducted protein extraction, western blotting and cell cultures and wrote the first and subsequent drafts of the manuscript. M.N.K. conducted the electrophysiological assays and wrote manuscript. S.G. conducted knockdown experiments and wrote manuscript. G.F.B. supervised and executed docking experiments and revised and edited the manuscript. A.F.C. supervised and designed experiments, conceptualized the project, revised and edited the manuscript and provided funding. A.F.M. supervised and designed experiments, conceptualized the project, wrote, revised and edited the manuscript and provided funding.

Competing interests

The authors declare no competing interests.

Additional information

Supplementary information The online version contains supplementary material available at <https://doi.org/10.1038/s41467-022-33835-3>.

Correspondence and requests for materials should be addressed to David Cabañero, Asia Fernández-Carvajal or Antonio Ferrer-Montiel.

Peer review information *Nature Communications* thanks Cristina Tassorelli and the anonymous reviewers for their contribution to the peer review of this work. Peer reviewer reports are available.

Reprints and permissions information is available at <http://www.nature.com/reprints>

Publisher's note Springer Nature remains neutral with regard to jurisdictional claims in published maps and institutional affiliations.

Open Access This article is licensed under a Creative Commons Attribution 4.0 International License, which permits use, sharing, adaptation, distribution and reproduction in any medium or format, as long as you give appropriate credit to the original author(s) and the source, provide a link to the Creative Commons license, and indicate if changes were made. The images or other third party material in this article are included in the article's Creative Commons license, unless indicated otherwise in a credit line to the material. If material is not included in the article's Creative Commons license and your intended use is not permitted by statutory regulation or exceeds the permitted use, you will need to obtain permission directly from the copyright holder. To view a copy of this license, visit <http://creativecommons.org/licenses/by/4.0/>.

© The Author(s) 2022